

**ÜRÜN
KATALOĐU**

**PRODUCT
CATALOG**

2018

35
years
Since 1983

Kurulduğumuz ilk günden bu yana, ülkemize ve insanımıza duyduğumuz güven, çalışma azmimizden hiçbir şey kaybetmeden daima yeniyi, daha iyiyi hedefleyerek ve günümüz teknolojisini yakından takip ederek 1983 yılından bu yana hep yanınızda olduk.

Since 1983, the first day we were founded, we have always been on your side by aiming for better and new without losing anything from our commitment to work with confidence that we have to our country and our people.





İÇİNDEKİLER INDEX



06

ANAHTAR GRUBU
SWITCH GROUP

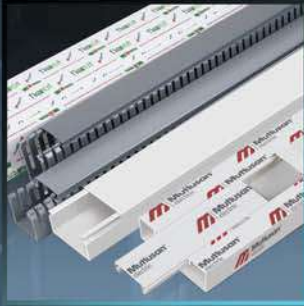

62

KABLO KANALLARI
CABLE TRUNKING



121

SANAYİ ÜRÜN GRUBU
INDUSTRIAL PRODUCT GROUP



157

TESİSAT MALZEMELERİ
INSTALLATION MATERIALS



205

AYDINLATMA GRUBU
LIGHTING GROUP

RITA SERİSİ
ELITRA PLUS SERİSİ
CANDELA SERİSİ
CANDELA KIDS
DARIA SERİSİ
NEMLİYER (SIVA ÜSTÜ)
BRON (SIVA ÜSTÜ)
GRUP PRİZLER
AKSESUARLAR

RITA SERIES
ELITRA PLUS SERIES
CANDELA SERIES
CANDELA KIDS
DARIA SERIES
NEMLİYER (SURFACE)
BRON (SURFACE)
GROUP SOCKETS
ACCESSORIES

HALOGEN FREE KABLO KANALI
KENDİNDEN KAPAKLI KANALLAR
DIŞTAN KAPAKLI KANALLAR
MEKS 100'LÜK SERİ PRİZ MONTAJ SETLERİ
MEKSPLUS SERİSİ İÇTEN KAPAKLI KANALLAR
SÜPÜRGELİK KABLO KANALLARI
ZEMİN KABLO KANALLARI
PROFİLLER
KLİMA KANALI
SİDEM SERİSİ KABLO KANALLAR
HALOGEN FREE DELİKLİ KABLO KANALI
DELİKLİ KABLO KANALI

HALOGEN FREE CABLE TRUNKING
CABLE TRUNKING WITH INTRINSIC COVER
CABLE TRUNKING WITH EXTERNAL COVER
MEKS 100 SERIES PLUG SOCKET ASSEMBLY SETS
MEKSPLUS SERIES INTERNAL COVER CABLE TRUNKING
SKIRTING BOARD CABLE TRUNKING
FLOOR CABLE TRUNKING
PROFILES
AIR CONDITIONING TRUNKING
SIDEM SERIES CABLE TRUNKING
HALOGEN FREE PERFORATED CABLE TRUNKING
PERFORATED CABLE TRUNKING

SANAYİ FİŞ - PRİZ GRUBU
SİNYAL VE KUMANDA BUTONLARI
ETANJ BUTON KUTULARI
VİNÇ KUMANDA BUTONLARI
SÜPER ETANJ RAKORLAR
RAY KLEMENSLER
SIKMALI TİP KABLO PAPUÇLARI
SIRA KLEMENSLER
RAYLAR, TOPRAKLAMA ÇUBUĞU VE BARALAR
DÖNER LAMBA, FLAŞÖRLÜ LAMBA VE SİRENLER
İKAZ LAMBALARI
TERMOPLASTİK BUATLAR

PLUG - SOCKET GROUP
SIGNAL AND CONTROL BUTTONS
WATERPROOF BUTTON BOXES
CRANE CONTROL BUTTONS
SUPER WATERPROOF CABLE GLANDS
RAIL TERMINAL BLOCKS
CLAMPING TYPE CABLE TERMINAL LUGS
CONNECTOR (TERMINAL BLOCKS)
RAILS, GROUNDING ROD AND BUSBARS
ROTATING BEACON, BLINKER BEACON AND SIRENS
WARNING LIGHTS
THERMOPLASTIC JUNCTION BOXES

COMFORT SİGORTA VE ZAYIF AKIM KUTULARI
W OTOMAT KUTULARI
TELEFON DAĞITIM KUTULARI VE AKSESUARLARI
MODÜL BAĞLANTI ÇATISI
ÇELİK SİRALLER PVC SİRALLER VE BORULAR
HALOGEN FREE SİRALLER
SİBOR SERİSİ BORULAR
SUSTALAR VE BUAT KAPAKLARI
BETON DUVAR KASALARI
PLASTİK KASA VE BUATLAR
KROŞELER
PLASTİK DÜBELLER

COMFORT FUSE AND LOW-CURRENT BOXES
FUSE BOXES
TELEPHONE DISTRIBUTION BOXES (HUBS) and ACCESSORIES
MODULE CONNECTION RACK
STEEL SPIRALS PVC SPIRALS AND PIPES
HALOGEN-FREE SPIRALS
SIBOR SERIES PIPES
CABLE PULLERS AND JUNCTION BOX COVERS
CONCRETE WALL CASINGS
PLASTIC CASINGS AND JUNCTION BOXES
CABLE STRAPS
PLASTIC DOWELS

LED AYDINLATMA ARMATÜRLERİ
PARABOLİK TAVAN ARMATÜRLERİ
YÜKSEK TAVAN AYDINLATMA ARMATÜRLERİ
BANT TİPİ ARMATÜRLER
TAVAN ARMATÜRLERİ
ACİL DURUM ARMATÜRLERİ

LED LIGHTING LUMINARIES
PARABOLIC CEILING LIGHTING FIXTURES
HIGH CEILING LIGHTING LUMINAIRE
BATTEN TYPE LUMINAIRE
CEILING LIGHTING FIXTURE
EMERGENCY LIGHTING



Mustafa KAÇMAZ
Yönetim Kurulu Başkanı
Chairman of the
Executive Board / CEO

Değerli Dostlarımız,

Endüstriyel hikâyemiz, 1983 yılında Karaköy Mağazamızda, Sektöre ve Ülkemize duyduğumuz güvenle başladı. Dönemin zor koşullarına rağmen, Mutlusan'ın geleceğine inandık. Koşullar nedeniyle kısıtlı miktarda başlattığımız üretim ve bunu takip eden uzun dönemdeki sabırlı çalışmalarımız ile günümüzde ortaya çıkan büyük Mutlusan ailemizin tohumlarını attık.

Mutlusan Ailesi olarak, zorlukları aşmak, yenilikçilik, dürüst ve işinin ehli üreticilik, tüketiciye ve müşterilerimize saygı, yatırım tutkusu gibi konularda ilk günkü heyecanla bugün de devam ediyoruz.

Son yıllarda hızlı bir değişim ve büyüme süreci yaşıyoruz. Yeni yatırımlar, teknolojik yenilenme, kurumsallaşma çalışmaları, yeniden yapılanma, yeni pazarlar ve yeni ürünlerle gelişimimizi sürekli hale getirmeye çalışıyoruz. Şirketimizde durmaksızın büyüme imkânları araştırılarak, verimliliğin artırılmasına yönelik planlamalar yapılıyor. Yenilikçilik desteklenerek, teknolojik altyapı güçlendiriliyor ve insan kaynaklarımızı zenginleştiriyoruz.

Geleneksel değerlerimizi koruyarak değişen dünyaya ayak uydurma başarısını sürekli kılmayı hedefliyoruz.

Küreselleşme sayesinde şirketler, ülkelerinden kilometrelerce uzaktaki tüketicilere yanı başlarındaymiş gibi ulaşabiliyorlar.

Ürünlerimizle milyonlarca kilometre ötedeki insanlara ulaşarak, onların yaşamlarına değer katmak için çalışıyoruz. Bu bize, Türkiye markası olarak sadece ülkemizi değil, dünyayı da anlamak zorunda olduğumuz mesajını veriyor.

Bu mesaj bize değişim sürecimizi, hem Türkiye hem de dünyadaki ekonomi ve Endüstriyel Enerji / Elektrik sektöründeki gelişmeleri yakından izleyerek yönetmemiz gerektiğini söylüyor.

Mutlusan Ailesi olarak, Sosyal sorumluluk anlayışımız, eğitim, spor, çevre, sağlık konularındaki gelişme ve iyileşmeleri teşvik eden bir yaklaşımdır. Bu konularda, ilgili sivil toplum kuruluşlarıyla çalışmalarımız devam edecektir.

1983 yılında, bu ülkenin geleceğine güvenerek çıktığımız bu yolda zaman bizleri haklı çıkardı. Bugün 40.000 metrekairelik üretim tesisi ve 550 kişilik çalışan kadromuzla birlikte, bu ülkede doğmuş bir markayı yöneten bizler, hem Türkiye'nin hem de Mutlusan'ın dünyadaki geleceğine inanıyor ve buna güveniyoruz.

Her zaman söylediğimiz ve hayat felsefemiz olan cümleyi tekrar etmek isterim.

“ Biz, Çalışırken Mutluyuz...”

Dear Friends,

Our industrial story began with confidence in the sector and our country in our Karaköy Store in 1983. Despite the difficult circumstances, we believed in the future of Mutlusan. We have sowed the seeds of our great Mutlusan family that emerged today with production we started in limited quantities due to the circumstances and our long-term patience.

As the Mutlusan Family, we continue today with the first day's excitement about overcoming challenges, innovating, honest and responsible production, respect for our customers and investment passion.

In recent years we are experiencing a rapid change and growth process. We are trying to make our investments with new investments, technological renewal, institutionalization studies, restructuring, new markets and new products. Our company is constantly searching for growth opportunities and planning to increase its productivity. By supporting innovation, we are strengthening our technological infrastructure and enriching our human resources.

We aim to keep the success of the changing world by sustaining our traditional values.

Thanks to globalization, companies are able to reach their customers as if they were close to customers who are kilometers away.

Reaching out to people thousands of kilometers away in our products, we strive to add value to their lives. This situation get the message to us, We as a Turkey brand have to understand the world as well not only our country.

This message says us; we need to manage our change process by watching closely developments in the both Turkey and the world economic and industrial Energy / Electricity sector.

As a Mutlusan Family, Social responsibility is an approach that promotes improvements and improvements in education, sport, environment, health issues. In these matters, we will continue to work with the relevant civil society organizations.

In 1983, we were justified in this way when we came to rely on the future of this country. Today we manage a brand that is born in this country with a 40,000 square meter production facility and 550 employees and believe both Turkey's and the Mutlusan future of the world.

We always say, and I would like to repeat the sentence which is our life philosophy.

"We Are Happy at Work ..."

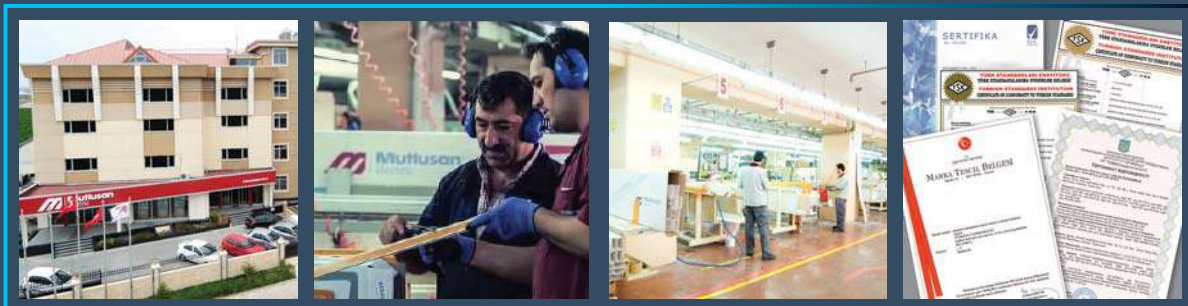



Rita

Elitra Plus

Candela

Candela Kids

Daria

Nemliyer • Wet Ground

Bron

Grup Prizler • Group Sockets

A nighttime photograph of a city street with tall buildings and streetlights. A large, light blue diamond shape is overlaid on the image, containing the text. The text is centered within the diamond.

ANAHTAR GRUBU
SWITCHES & SOCKETS GROUP

**ANAHTAR
MEKANİZMA**
SWITCHES
MECHANISM

Mükemmel tasarımı
dış görünümü ve
yenilenen iç
mekanizması ile

KUSURSUZ ...

With its perfectly
designed exterior and
renewed interior
mechanics

PERFECT...

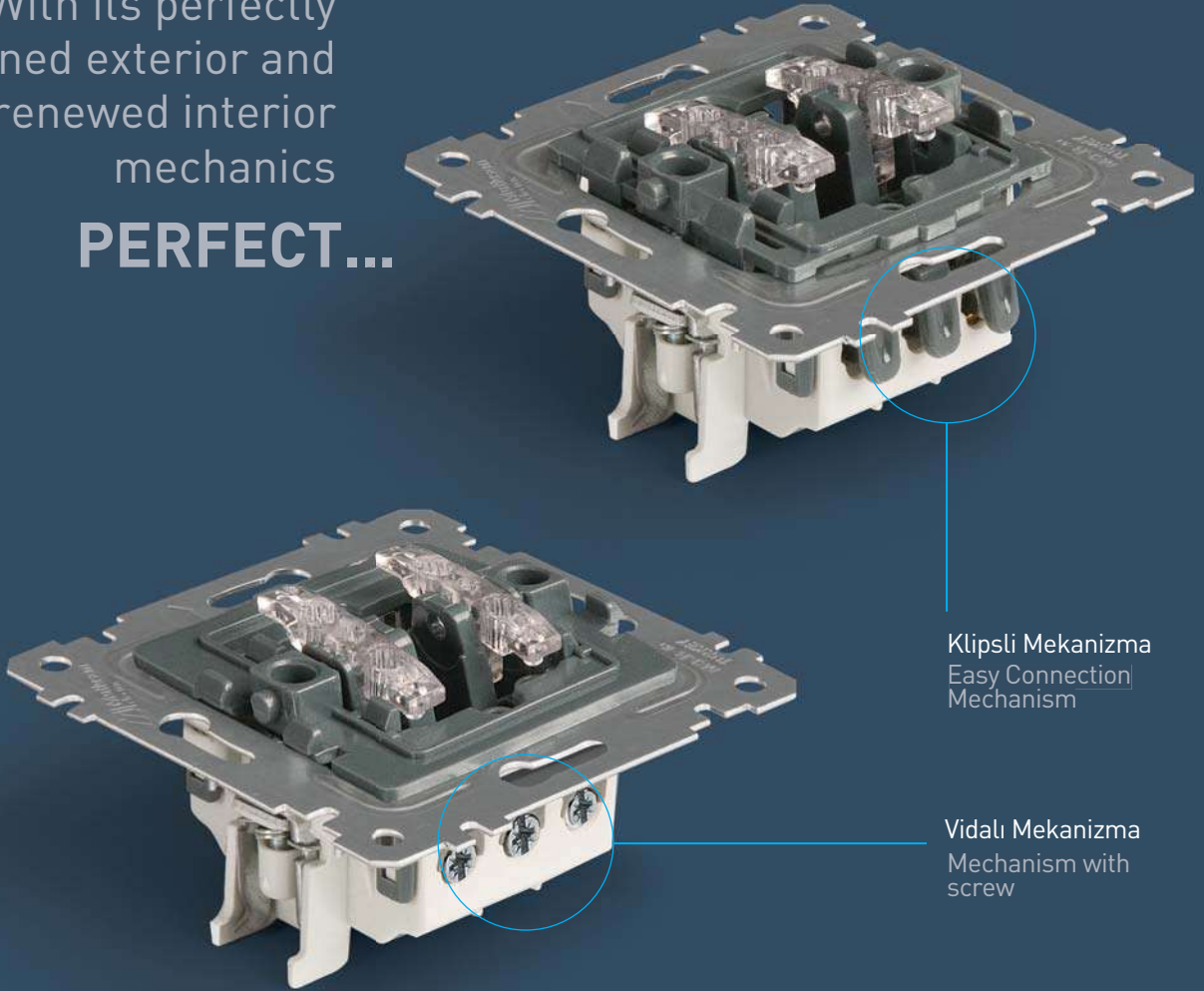

Klipsli Mekanizma
Easy Connection
Mechanism

Vidalı Mekanizma
Mechanism with
screw

Rita

SERİSİ / SERIES

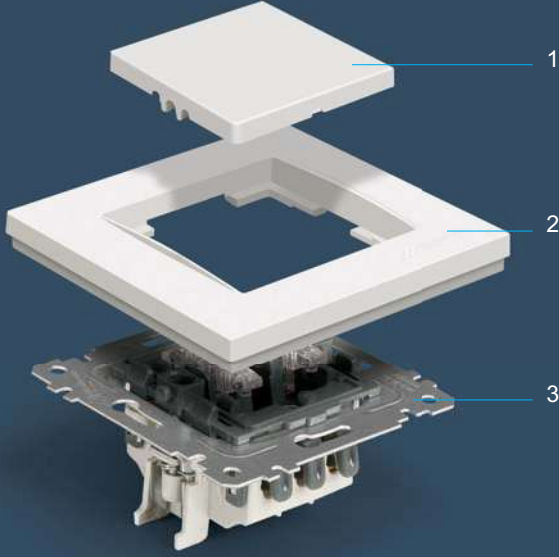

- 1 - Tuş / Plate
- 2- Çerçeve / Frame
- 3- Mekanizma / Mechanizm

Elitra Plus

SERİSİ / SERIES

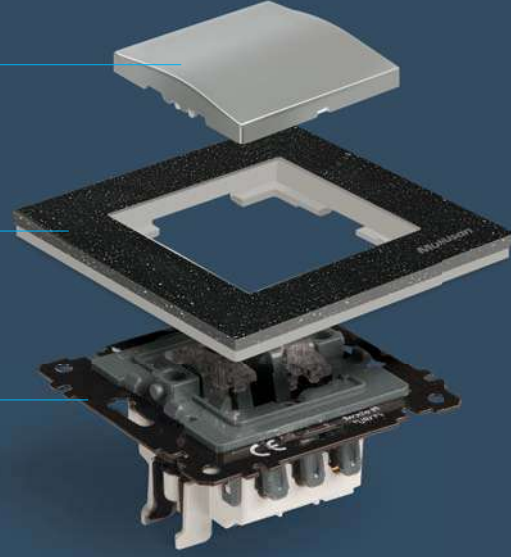

- 1 - Tuş / Plate
- 2- Çerçeve / Frame
- 3- Mekanizma / Mechanizm

Candela

SERİSİ / SERIES

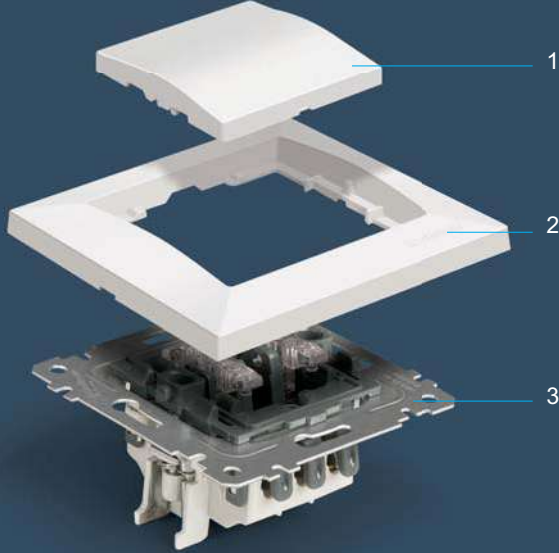

- 1 - Tuş / Plate
- 2- Çerçeve / Frame
- 3- Mekanizma / Mechanizm

Daria

SERİSİ / SERIES



- 1 - Tuş / Plate
- 2- Çerçeve / Frame
- 3- Mekanizma / Mechanizm

Rita
SERİSİ
SERIES

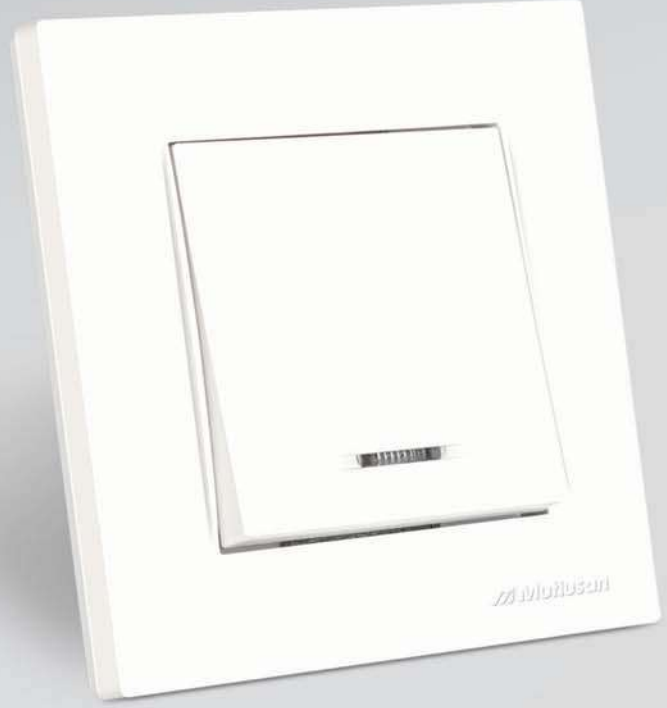

Akılcı çözümler...

Teknolojik ürünleri ince detaylı tasarımlarla hayatınıza kattık, size keyfini çıkarmak kaldı.

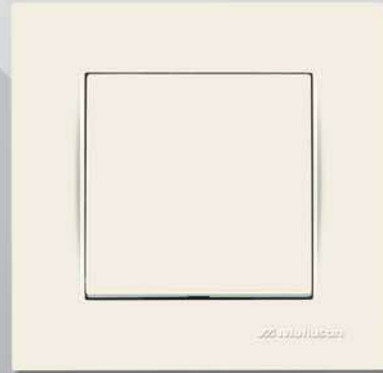
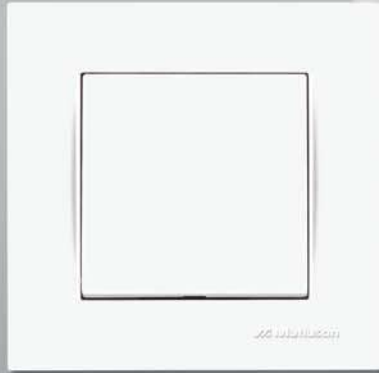

Pastel

PASTEL • PASTEL



Rational solutions ...

We bring Technological products with fine detail design to your life, it's up to you to enjoy.



Metallic

METALİK • METALLIC

Rita
SERİSİ
SERIES



Yeniliklerin müjdecisi...

Artık daha teknolojik bir hayat var...

Rita serisi yenilikçi ürünleri ile hayatınızı kolaylaştırmak için yanınıza...





The herald of innovation ...

Now there are more technological life ...
The Rita series is at your side to make your life easier with
innovative products ...



Rita
ÇERÇEVELER
FRAMES

İKİLİ PRİZLER DOUBLE SOCKETS



ÇERÇEVELER

Tekliden altılıya kadar
çoklu anahtar ihtiyaçlarınızın
çözümü...

FRAMES

Multi-key solution for your
needs from single up to six...

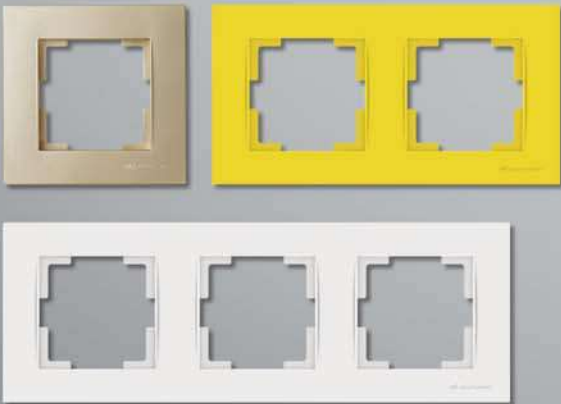

TELEFON TUTUCU TELEPHONE HOLDER



YENİ
ÜRÜN
NEW



2200 800 00XX

RENK SEÇENEKLERİ COLORS OPTIONS

NATUREL • NATURAL



XX : 01 Beyaz • White



XX : 02 Krem • Cream

PASTEL • PASTEL



Çerçeve (XX)
03 Gri • Grey



Çerçeve (XX)
04 Kırmızı • Red



Çerçeve (XX)
06 Turuncu • Orange



Çerçeve (XX)
08 Sarı • Yellow



Çerçeve (XX)
09 Lacivert • Navy Blue



Çerçeve (XX)
10 Yeşil • Green



Çerçeve (XX)
11 Pembe • Pink



Çerçeve (XX)
12 Mavi • Blue



Çerçeve (XX)
25 Mor • Purple

METALİK • METALLIC



XX : 80
Antik altın • Antique gold



XX : 82 İnoks • Inox



XX : 83
Titanyum • Titanium



XX : 84 Siyah • Black



XX : 95 Füme • Smoked

AHŞAP DESEN • WOOD PATTERN



XX : 56 Kiraz • Cherry



XX : 57 Ceviz • Walnuts



XX : 58 Meşe • Oak

YATAY ÇERÇEVELER • HORIZONTAL FRAMES

2220 800 11 XX
1'li Çerçeve • 1 Gang frame



2220 800 12 XX
2'li Çerçeve • 2 Gang frame



2220 800 13 XX
3'lü Çerçeve • 3 Gang frame



2220 800 14 XX
4'lü Çerçeve • 4 Gang frame



2220 800 15 XX
5'li Çerçeve • 5 Gang frame



2220 800 16 XX
6'li Çerçeve • 6 Gang frame



DİKEY ÇERÇEVELER • VERTICAL FRAMES

2220 800 22 XX
2'li Çerçeve
2 Gang frame



2220 800 23 XX
3'lü Çerçeve
3 Gang frame



2220 800 24 XX
4'lü Çerçeve
4 Gang frame

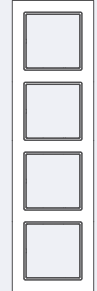

2220 800 25 XX
5'li Çerçeve
5 Gang frame



2220 800 26 XX
6'li Çerçeve
6 Gang frame



Bu ürün kodlarında XX çerçeve rengini belirtmektedir.
XX specify frame color for these products.

Rita

TEKNİK BİLGİLER
TECHNICAL FEATURES

BOYUTLAR • DIMENSIONS

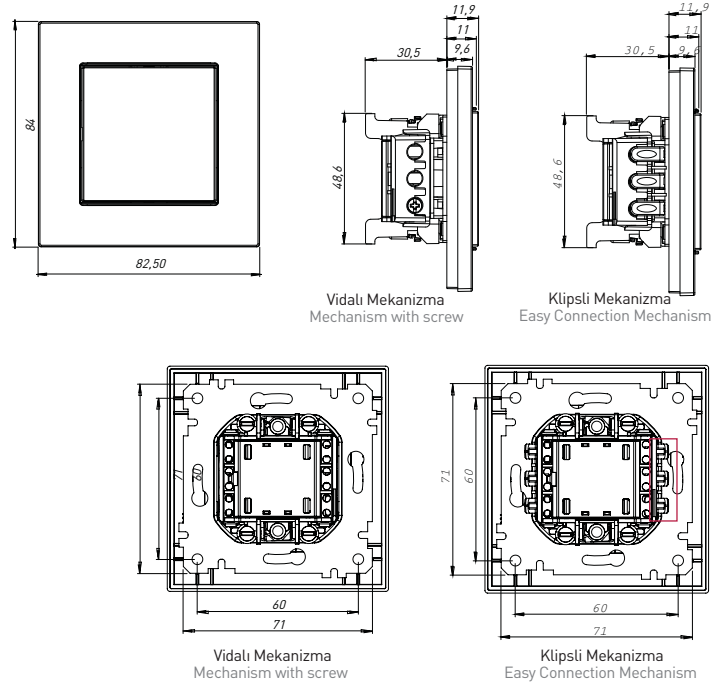

MEKANİZMA + TUŞ ÜRÜN LİSTESİ • MECHANISM + PLATE PRODUCT LIST

Kod / Code	Ürün Tanımı	Description
ANAHTAR GRUBU VİDALI		
SWITCH GROUP (WITH SCREW)		
2200 401 02XX	ANAHTAR (VİDALI)	ONE GANG ONE WAY SWITCH
2200 402 02XX	KOMÜTATÖR (VİDALI)	TWO GANG ONE WAY SWITCH
2200 403 02XX	VAVİEN(İKİ YOLLU ANAHTAR) (VİDALI)	ONE GANG TWO WAY SWITCH (VA-ET-VIENT)
2200 404 02XX	KOMÜTATÖR VAVİEN (VİDALI)	TWO GANG TWO WAY SWITCH (COMMUTATOR VEAVIEN)
2200 405 02XX	ÇİFT KUTUPLU ANAHTAR (VİDALI)	DOUBLE POLE SWITCH
2200 406 02XX	JALUZİ ANAHTARI-YAYLI (VİDALI)	BLIND SWITCH (CONTROL SWITCH)
2200 407 02XX	ÇAĞIRMA (LİGH) (VİDALI)	ONE GANG ONE WAY SWITCH (LIGHT) (PUSH Plate)
2200 407 02XXK	KAPI OTOMATIĞI ANAHTARI (VİDALI)	DOOR SWITCH
2200 407 02XXZ	ZİL ANAHTARI (VİDALI)	BELL SWITCH
2200 408 02XX	DEVİATÖR (ARA VAVİEN) (VİDALI)	ONE GANG INTERMEDIATE SWITCH
2200 409 02XX	ÜÇLÜ ANAHTAR (VİDALI)	THREE GANG ONE WAY SWITCH
2200 411 02XX	ŞOFBEN ANAHTARI (VİDALI)	HEATER SWITCH
2200 415 02XX	IŞIKLI ANAHTAR (220V) (VİDALI)	ILLUMINATED ONE (220V)GANG ONE WAY SWITCH
2200 416 02XX	IŞIKLI VAVİEN (220V) (VİDALI)	ILLUMINATED ONE GANG TWO WAY
2200 417 02XX	IŞIKLI ÇAĞIRMA(220V) (VİDALI)	ILLUMINATED ONE GANG ONE WAY (PUSH Plate) SWITCH)
2200 418 02XX	IŞIKLI ETİKETLİ ANAHTAR (220V) (VİDALI)	ILLUMINATED 1 G 1 W SWITCH WITH LABEL
2200 419 02XX	IŞIKLI ETİKETLİ ÇAĞIRMA (220V) (VİDALI)	ILLUMINATED 1 G 1 W SWITCH WITH LABEL (PUSH Plate)
2200 422 02XX	IŞIKLI ZİL ÇAĞIRMA (12V) (VİDALI)	ILLUMINATED ONE GANG ONE WAY SWITCH (PUSH Plate)
2200 426 02XX	IŞIKLI KOMÜTATÖR (VİDALI)	ILLUMINATED TWO GANG ONE WAY SWITCH (220V)
ANAHTAR GRUBU KLİPSLİ		
SWITCH GROUP EASY CONNECTION		
2200 401 01XX	ANAHTAR (KLİPSLİ)	ONE GANG ONE WAY SWITCH
2200 402 01XX	KOMÜTATÖR (KLİPSLİ)	TWO GANG ONE WAY SWITCH
2200 403 01XX	VAVİEN(İKİ YOLLU ANAHTAR) (KLİPSLİ)	ONE GANG TWO WAY SWITCH (VA-ET-VIENT)
2200 404 01XX	KOMÜTATÖR VAVİEN (KLİPSLİ)	TWO GANG TWO WAY SWITCH (COMMUTATOR VEAVIEN)
2200 405 01XX	ÇİFT KUTUPLU ANAHTAR (KLİPSLİ)	DOUBLE POLE SWITCH
2200 406 01XX	JALUZİ ANAHTARI-YAYLI (KLİPSLİ)	BLIND SWITCH (CONTROL SWITCH)
2200 407 01XX	ÇAĞIRMA (LİGH) (KLİPSLİ)	ONE GANG ONE WAY SWITCH (LIGHT) (PUSH Plate)
2200 407 01XXK	KAPI OTOMATIĞI ANAHTARI (KLİPSLİ)	DOOR SWITCH
2200 407 01XXZ	ZİL ANAHTARI (KLİPSLİ)	BELL SWITCH
2200 408 01XX	DEVİATÖR (ARA VAVİEN) (KLİPSLİ)	ONE GANG INTERMEDIATE SWITCH
2200 409 01XX	ÜÇLÜ ANAHTAR (KLİPSLİ)	THREE GANG ONE WAY SWITCH
2200 415 01XX	IŞIKLI ANAHTAR (220V) (KLİPSLİ)	ILLUMINATED ONE (220V)GANG ONE WAY SWITCH
2200 416 01XX	IŞIKLI VAVİEN (220V) (KLİPSLİ)	ILLUMINATED ONE GANG TWO WAY
2200 417 01XX	IŞIKLI ÇAĞIRMA(220V) (KLİPSLİ)	ILLUMINATED ONE GANG ONE WAY (PUSH Plate) SWITCH)
2200 418 01XX	IŞIKLI ETİKETLİ ANAHTAR (220V) (KLİPSLİ)	ILLUMINATED 1 G 1 W SWITCH WITH LABEL
2200 419 01XX	IŞIKLI ETİKETLİ ÇAĞIRMA (220V) (KLİPSLİ)	ILLUMINATED 1 G 1 W SWITCH WITH LABEL (PUSH Plate)
2200 422 01XX	IŞIKLI ZİL ÇAĞIRMA (12V) (KLİPSLİ)	ILLUMINATED ONE GANG ONE WAY SWITCH (PUSH Plate)
2200 426 01XX	IŞIKLI KOMÜTATÖR (KLİPSLİ)	ILLUMINATED TWO GANG ONE WAY SWITCH (220V)

MEKANİZMA + TUŞ ÜRÜN LİSTESİ • MECHANISM + PLATE PRODUCT LIST

Kod / Code	Ürün Tanımı	Description
DİMMER GRUBU		DIMMER GROUP
2200 440 02XX	İŞIKLI DİMMER (600 W)	RL ILLUMINATED DIMMER (600 W)
2200 443 02XX	İŞIKLI DİMMER CE'Lİ (600 W) FİLTRELİ	RL ILLUMINATED DIMMER (600 W CE)
2200 444 02XX	İŞIKLI DİMMER (1000 W)	RL ILLUMINATED DIMMER (1000 W)
2200 445 02XX	RLC DİMMER (10-300W)	RLC DIMMER (10-300W)
ELEKTRONİK GRUBU		ELECTRONIC GROUP
2200 450 02XX	ENERGY SAVER GEÇİKMESİZ İŞIKLI	ENERGY SAVER ILLUMINATED
2200 452 02XX	ENERGY SAVER GEÇİKMELİ İŞIKLI	ENERGY SAVER WITH DELAY
2200 470 02XX	MÜZİK YAYIN ANAHTARI	AUDIO SWITCH
2200 480 02XX	HOPARLÖR PRİZİ	SPEAKER SOCKET
2200 485 02XX	UYARI ZİLİ	WARNING SWITCH
2200 495 02XX	HAREKET SENSÖRÜ	MOVEMENT SENSOR
PRİZ GRUBU		SOCKET GROUP
2200 600 02XX	TOPRAKLI PRİZ	EARTHED SOCKET OUTLET
2200 601 02XX	TOPRAKSIZ PRİZ	SOCKET OUTLET NON- EARTHED
2200 605 02XX	TOPRAKLI PRİZ (ÇOCUK KORUMALI)	EARTHED SOCKET WITH CHILD PROTECTION
2200 606 02XX	TOPRAKSIZ PRİZ (ÇOCUK KORUMALI)	SOCKET OUTLET WITH CHILD PROTECTION NON EARTHED
2200 610 02XX	KAPAKLI TOPRAKLI PRİZ	EARTHED SOCKET WITH COVER
2200 611 02XX	KAPAKLI TOPRAKLI PRİZ (ÇOCUK KORUMALI)	EARTHED SOCKET WITH CHILD PROTECTION COVER
2200 615 02XX	UPS (FRANSIZ) PRİZİ	UPS (FRENCH) SOCKET (EARTHED SOCKET WITH PIN)
2200 616 02XX	UPS (FRANSIZ) PRİZİ (ÇOCUK KORUMALI)	UPS (FRENCH) SOCKET (CHILD PROTECTION)
2200 617 02XX	UPS KAPAKLI(FRANSIZ) PRİZİ	UPS SOCKET (FRENCH) WITH COVER
2200 618 02XX	UPS (FRANSIZ)KAP. TOPRAKLI PRİZ (ÇOC.KRM)	UPS SOCKET (FRENCH) WITH COVER (CHILD PROTECTION)
2200 200 02XX	İKİLİ TOPRAKLI PRİZ (PORSELEN)	DOUBLE SOCKET EARTHED PORCELAIN
2200 201 02XX	İKİLİ TOPRAKSIZ PRİZ (PORSELEN)	DOUBLE SOCKET (NON EARTHED) PORCELAIN
2200 202 02XX	İKİLİ TOPRAKLI PRİZ	DOUBLE SOCKET EARTHED
2200 203 02XX	İKİLİ TOPRAKSIZ PRİZ	DOUBLE SOCKET (NON EARTHED)
2200 215 01XX	İKİLİ UPS PRİZ	DOUBLE SOCKET WITH UPS (FRENCH)
2200 448 02XX	TEKLİ USB ŞARJ PRİZİ	USB CHARGE SOCKET
2200 449 02XX	İKİLİ USB ŞARJ PRİZİ	USB CHARGE TWO SOCKET
İLETİŞİM GRUBU		COMMUNICATIONS GROUP
2200 125 01XX	TELEFON PRİZİ 1*RJ12 (CAT 3)	TELEPHONE SOCKET 1*RJ12 (CAT 3)
2200 126 01XX	TELEFON PRİZİ 2*RJ12 (CAT 3)	TELEPHONE SOCKET 2*RJ12 (CAT 3)
2200 128 01XX	ETİKETLİ TELEFON DATA PRİZ (KON.SÜZ)	TELEPHONE DATA SOCKET WITH LABEL (WITHOUT CONNECTOR)
2200 135 02XX	DATA PRİZ 1*RJ45 (KONNEKTÖRSÜZ)	DATA SOCKET 1*RJ45 (WITHOUT CONNECTOR)
2200 136 01XX	DATA PRİZ 1*RJ45 (CAT 5E)	DATA SOCKET 1*RJ45 (CAT 5E)
2200 137 01XX	DATA PRİZ 2*RJ45 (KONNEKTÖRSÜZ)	DATA SOCKET 2*RJ45 (WITHOUT CONNECTOR)
2200 138 01XX	DATA PRİZ 2*RJ45 (CAT 5E)	DATA SOCKET 2*RJ45 (CAT 5E)
2200 139 01XX	DATA PRİZ (RJ12 CAT 3+CAT 5 E)	DATA SOCKET (RJ12 CAT 3+CAT 5 E)
2200 140 01XX	DATA PRİZ 1*RJ45 (CAT 6)	DATA SOCKET 1*RJ45 (CAT 6)
2200 141 01XX	DATA PRİZ 2*RJ45 (CAT 6)	DATA SOCKET 2*RJ45 (CAT 6)
2200 455 01XX	DATA PRİZ 1*USB	DATA SOCKET 1* USB
2200 456 01XX	DATA PRİZ 2*USB	DATA SOCKET 2* USB
2200 457 01XX	DATA PRİZ 1*HDMI	DATA SOCKET 1*HDMI
2200 458 01XX	DATA PRİZ 2*HDMI	DATA SOCKET 2*HDMI
2200 459 01XX	DATA PRİZ 1*USB / 1*HDMI	DATA SOCKET 1*USB / 1*HDMI
2200 460 01XX	VGA PRİZ	VGA SOCKET
2200 121 02XX	KÖR KAPAK	BLIND COVER
TV / SAT GRUBU		TV / SAT GROUP
2200 156 02XX	TV / SAT PRİZİ (GEÇİŞLİ) 4DB/F KON.	TV / SAT SOCKET (THROUGH) 4DB/F CON.
2200 157 02XX	TV / SAT PRİZİ (SONLU)	TV / SAT SOCKET (DEAD-END)
2200 166 01XX	SAT PRİZİ (GEÇİŞLİ) 4DB/F KON.	SAT SOCKET (THROUGH)
2200 167 01XX	SAT PRİZİ (SONLU)	SAT SOCKET (DEAD-END)
2200 170 01XX	TV PRİZİ (GEÇİŞLİ) 11 DB	TV SOCKET (THROUGH) 11 DB
2200 171 01XX	TV PRİZİ (SONLU)	TV SOCKET (DEAD-END)
2200 172 01XX	TV PRİZİ F DİŞİ	TV SOCKET F FEMALE
SIVAÜSTÜ KASA		SURFACE BOX
2100 000 11XX	SIVAÜSTÜ KASA	SURFAC MOUNTED BOX
AKSESUAR		ACCESSORIES
2200 800 00XX	TELEFON TUTUCU	TELEPHONE HOLDER

ELEKTRONİK ELECTRONIC



RCA PRİZ



USB PRINTER PRİZ



SPEAKHONE PRİZ



XLR DIŞI PRİZ



XLR ERKEK PRİZ



XLR 3,5 SES JAKI

ÜRÜN LİSTESİ • PRODUCT LIST

Kod / Code	Ürün Tanımı	Description
2200 250 01XX	RİTA SPEAKHONE PRİZ	RITA SPEAKHONE
2200 251 01XX	RİTA RCA PRİZ	RITA RCA SOCKET
2200 252 01XX	RİTA 3,5 SES JAKI	RITA 3,5 AUDIO CONNECTOR
2200 253 01XX	RİTA XLR ERKEK PRİZ	RITA XLR MALE SOCKET
2200 254 01XX	RİTA XLR DIŞI PRİZ	RITA XLR FEMALE SOCKET
2200 255 01XX	RİTA USB PRINTER	RITA USB PRINTER SOCKET
2100 250 01XX	SPEAKHONE PRİZ	SPEAKHOMNE SOCKET
2100 251 01XX	RCA PRİZ	RCA SOCKET
2100 252 01XX	3,5 SES JAKI	3,5 AUDIO CONNECTOR
2100 253 01XX	XLR ERKEK PRİZ	XLR MALE SOCKET
2100 254 01XX	XLR DIŞI PRİZ	XLR FEMALE SOCKET
2100 255 01XX	USB PRINTER PRİZ	USB PRINTER SOCKET



ÜRÜN LİSTESİ • PRODUCT LIST

Kod / Code	Ürün Tanımı	Description
2100 850 0000	RADYO FREKANSLI ENERGY SAVER	RADIO FREQUENCY ENERGY SAVER
2100 851 0000	2X16A ENERGY SAVER ROLE PCB (VRF/FC)	2X16A ENERGY SAVER RELAY PCB (VRF/FC)
2100 852 0000	30A + 16A ENERGY SAVER ROLE PCB (VRF/FC)	30A+16A ENERGY SAVER RELAY PCB(VRF/FC)
2100 853 0000	3X16A ENERGY SAVER ROLE PCB (VRF/FC)	3X16A ENERGY SAVER - DND RELAY PCB (VRF/FC)
2100 854 0000	3X16A ENERGY SAVER - DND ROLE PCB (VRF/FC)	30A+2X16A ENERGY SAVER - DND RELAY PCB (VRF/FC)
2100 855 0000	30A+2X16A ENERGY SAVER - DND ROLE PCB (VRF/FC)	30A+2X16A ENERGY SAVER - DND RELAY PCB (VRF/FC)
2110 052 00XX	ENERGY SAVER KAPAK	ENERGY SAVER COVER
2220 010 01XX	RİTA OTEL UYARI İÇ ÜNİTESİ KOMÜTATÖRÜ (MEKANİK) IŞIKLI (KLİPSLİ)	RITA HOTEL INTERIOR WARNING UNIT 2 GANG 1 WAY - MECHANICAL ILLUMINATED WITH (EASY CONNECTION)
2220 010 02XX	RİTA OTEL UYARI İÇ ÜNİTESİ KOMÜTATÖRÜ (MEKANİK) IŞIKLI (VİDALI)	RITA HOTEL INTERIOR WARNING UNIT 2 GANG 1 WAY - MECHANICAL ILLUMINATED WITH (WITH SCREW)
2200 412 01XX	RİTA MEKANİZMA+TUŞ IMPLUS ANAHTAR (KLİPSLİ)	RITA MECHANISM+PLATE IMPLUS 1 GANG 1 WAY (EASY CONNECTION)
2200 412 02XX	RİTA MEKANİZMA+TUŞ IMPLUS ANAHTAR (VİDALI)	RITA MECHANISM+PLATE IMPLUS 1 GANG 1 WAY (WITH SCREW)
2200 423 01XX	RİTA MEKANİZMA+TUŞ IMPLUS KOMÜTATÖR (KLİPSLİ)	RITA MECHANISM + PLATE IMPLUS 2 GANG 1 WAY (EASY CONNECTION)
2200 423 02XX	RİTA MEKANİZMA+TUŞ IMPLUS KOMÜTATÖR (VİDALI)	RITA MECHANISM + PLATE IMPLUS 2 GANG 1 WAY (WITH SCREW)
2200 424 01XX	RİTA MEKANİZMA+TUŞ IMPLUS IŞIKLI ANAHTAR (KLİPSLİ)	RITA MECHANISM + PLATE IMPLUS ILLUMINATED 1 GANG 1 WAY SWITCH (EASY CONNECTION)
2200 424 02XX	RİTA MEKANİZMA+TUŞ IMPLUS IŞIKLI ANAHTAR (VİDALI)	RITA MECHANISM + PLATE IMPLUS ILLUMINATED 1 GANG 1 WAY SWITCH (WITH SCREW)
2200 427 01XX	RİTA MEKANİZMA+TUŞ IMPLUS IŞIKLI KOMÜTATÖR (KLİPSLİ)	RITA MECHANISM + PLATE IMPLUS ILLUMINATED 2 GANG 1 WAY (EASY CONNECTION)
2200 427 02XX	RİTA MEKANİZMA+TUŞ IMPLUS IŞIKLI KOMÜTATÖR (VİDALI)	RITA MECHANISM + PLATE IMPLUS ILLUMINATED 2 GANG 1 WAY (WITH SCREW)
2100 010 01XX	OTEL UYARI İÇ ÜNİTESİ KOMÜTATÖRÜ (MEKANİK) IŞIKLI (KLİPSLİ)	HOTEL INTERIOR WARNING UNIT 2 GANG 1 WAY - MECHANICAL ILLUMINATED WITH (EASY CONNECTION)
2100 010 02XX	OTEL UYARI İÇ ÜNİTESİ KOMÜTATÖRÜ (MEKANİK) IŞIKLI (VİDALI)	HOTEL INTERIOR WARNING UNIT 2 GANG 1 WAY - MECHANICAL ILLUMINATED WITH (WITH SCREW)
2100 412 01XX	IMPLUS ANAHTAR (KLİPSLİ)	IMPLUS ONE GANG ONE WAY SWITCH (EASY CONNECTION)
2100 412 02XX	IMPLUS ANAHTAR (VİDALI)	IMPLUS ONE GANG ONE WAY SWITCH (WITH SCREW)
2100 423 01XX	IMPLUS KOMÜTATÖR (KLİPSLİ)	IMPLUS TWO GANG ONE WAY SWITCH (EASY CONNECTION)
2100 423 02XX	IMPLUS KOMÜTATÖR (VİDALI)	IMPLUS TWO GANG ONE WAY SWITCH (WITH SCREW)
2100 424 01XX	IMPLUS IŞIKLI ANAHTAR (220 V) (KLİPSLİ)	IMPLUS ILLUMINATED 1 GANG 1 WAY SWITCH (220V) (EASY CONNECTION)
2100 424 02XX	IMPLUS IŞIKLI ANAHTAR (220 V) (VİDALI)	IMPLUS ILLUMINATED 2 GANG 1 WAY SWITCH (WITH SCREW)
2100 427 01XX	IMPLUS IŞIKLI KOMÜTATÖR (KLİPSLİ)	IMPLUS 1 GANG 1 WAY SWITCH (EASY CONNECTION)
2100 427 02XX	IMPLUS IŞIKLI KOMÜTATÖR (VİDALI)	IMPLUS 2 GANG 1 WAY SWITCH (WITH SCREW)

Elitra|Plus

SERİSİ
SERIES



Göz alıcı ...

Usta elinden çıkmış, incelikle düşünülmüş nadir bir mücevher gibi göz alacak...



Chrome

KROM • CHROME



Eye-catching ...

Eye-catching as a rare jewel of master craftsmanship, delicately conceived...



Elitra|Plus

SERİSİ
SERIES



Seçkin ürünler...

Formunu ve desenini doğanın eşsiz görünümünden alan sadeliği ile ön plana çıkan seçkin ürünler...





Excellent products...

Excellent products that come to the forefront with the design of the form and the design with the unique appearance of nature ...



Elitra|Plus

SERİSİ
SERIES



Sıradanlığa meydan okuyun...

Modern mekanların vazgeçilmez üyeleri,
farklı beğenilere cevap verebilmek için tasarlandı...

Challenge ordinariness...

Indispensable members of
modern spaces are
designed to respond to
different tastes ...



Elitra|Plus

ÇERÇEVELER
FRAMES

ÇERÇEVELER

Tekliden altılıya kadar çoklu anahtar ihtiyaçlarınızın çözümü...

FRAMES

Multi-key solution for your needs from single up to six...

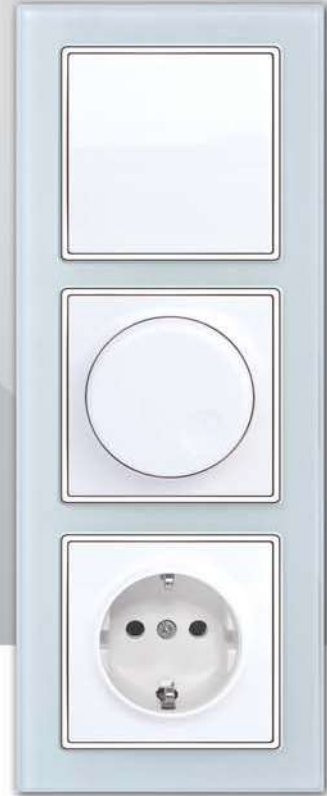
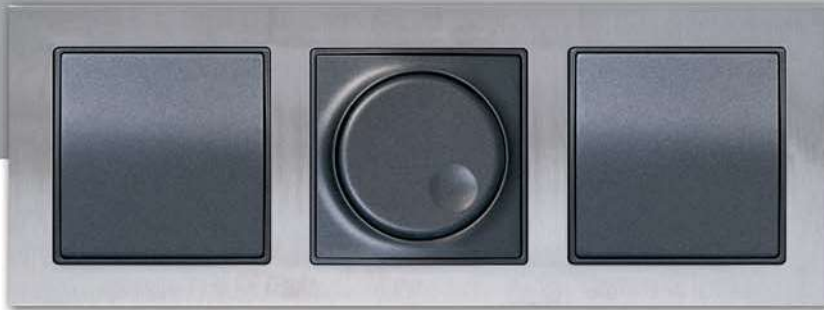

RENK SEÇENEKLERİ COLORS OPTIONS

Elitra Glass



Cerçeve [XX] : 11 Beyaz
Tuş [YY] : 01 Beyaz
Frame [XX] : 11 White
Plate [YY] : 01 White



Cerçeve [XX] : 14 Siyah
Tuş [YY] : 92 Gümüş
Frame [XX] : 14 Black
Plate [YY] : 92 Silver

Elitra Chrome



Cerçeve [XX] : 21 Krom
Tuş [YY] : 95 Fümé
Frame [XX] : 21 Chrome
Plate [YY] : 95 Smoked



Cerçeve [XX] : 22 Altın
Tuş [YY] : 90 Saten
Frame [XX] : 22 Gold
Plate [YY] : 90 Satin



Cerçeve [XX] : 24 Paslanmaz Çelik
Tuş [YY] : 95 Fümé
Frame [XX] : 24 Stainless Stell
Plate [YY] : 95 Smoked



Cerçeve [XX] : 25 Parlak Fümé
Tuş [YY] : 92 Gümüş
Frame [XX] : 25 Bright Smoked
Plate [YY] : 92 Silver



Cerçeve [XX] : 25 Parlak Fümé
Tuş [YY] : 95 Fümé
Frame [XX] : 25 Bright Smoked
Plate [YY] : 95 Smoked



Cerçeve [XX] : 27 Mat Alüminyum
Tuş [YY] : 95 Fümé
Frame [XX] : 27 Mat Aluminium
Plate [YY] : 95 Smoked



Cerçeve [XX] : 28 Mat Saten
Tuş [YY] : 90 Saten
Frame [XX] : 28 Mat Satin
Plate [YY] : 90 Satin

Elitra Wood



Cerçeve [XX] : 32 Kayın
Tuş [YY] : 92 Gümüş
Frame [XX] : 32 Beech
Plate [YY] : 92 Silver



Cerçeve [XX] : 33 Kiraz
Tuş [YY] : 90 Saten
Frame [XX] : 33 Cherry
Plate [YY] : 90 Satin



Cerçeve [XX] : 34 Venge
Tuş [YY] : 92 Gümüş
Frame [XX] : 34 Venge
Plate [YY] : 92 Silver

Elitra Marble



Cerçeve [XX] : 42 Black Quartz
Tuş [YY] : 92 Gümüş
Frame [XX] : 42 Black Quartz
Plate [YY] : 92 Silver



Cerçeve [XX] : 43 Sand Stone
Tuş [YY] : 92 Gümüş
Frame [XX] : 43 Sand Stone
Plate [YY] : 92 Silver

Elitra Ale



Cerçeve [XX] : 51 Natural
Tuş [YY] : 95 Fümé
Frame [XX] : 51 Natural
Plate [YY] : 92 Smoked



Cerçeve [XX] : 52 Saten
Tuş [YY] : 90 Saten
Frame [XX] : 52 Satin
Plate [YY] : 90 Satin



Cerçeve [XX] : 53 Mat Fümé
Tuş [YY] : 92 Gümüş
Frame [XX] : 53 Mat Smoked
Plate [YY] : 92 Silver

YATAY ÇERÇEVELER • HORIZONTAL FRAMES

2170 8XX 11YY
1'li Çerçeve • 1 Gang frame



2170 8XX 12YY
2'li Çerçeve • 2 Gang frame



2170 8XX 13YY
3'lü Çerçeve • 3 Gang frame



2170 8XX 14YY
4'lü Çerçeve • 4 Gang frame



2170 8XX 15YY
5'li Çerçeve • 5 Gang frame

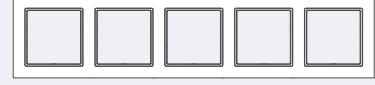

2170 8XX 16YY
6'li Çerçeve • 6 Gang frame



DIKEY ÇERÇEVELER • VERTICAL FRAMES

2170 8XX 22YY
2'li Çerçeve
2 Gang frame



2170 8XX 23YY
3'lü Çerçeve
3 Gang frame



2170 8XX 24YY
4'lü Çerçeve
4 Gang frame

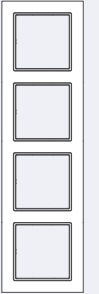

2170 8XX 25YY
5'li Çerçeve
5 Gang frame



2170 8XX 26YY
6'li Çerçeve
6 Gang frame



Bu ürün kodlarında XX çerçeve rengini YY kordon rengini belirtmektedir.
For these products, XX indicates frame color, YY cord color.

Elitra Plus

TEKNİK BİLGİLER
TECHNICAL FEATURES

BOYUTLAR • DIMENSIONS

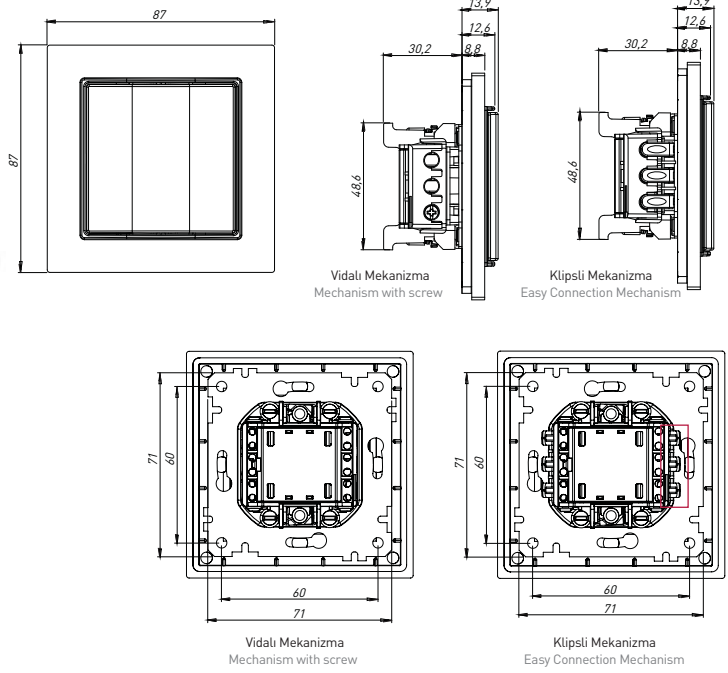

MEKANİZMA + TUŞ ÜRÜN LİSTESİ • MECHANISM + PLATE PRODUCT LIST

Kod / Code	Ürün Tanımı	Description
ANAHTAR GRUBU VİDALI		SWITCH GROUP (WITH SCREW)
2270 401 02XX	ANAHTAR (VİDALI)	ONE GANG ONE WAY SWITCH
2270 402 02XX	KOMÜTATÖR (VİDALI)	TWO GANG ONE WAY SWITCH
2270 403 02XX	VAVİEN (İKİ YOLLU ANAHTAR) (VİDALI)	ONE GANG TWO WAY SWITCH (VA-ET-VIENT)
2270 404 02XX	KOMÜTATÖR VAVİEN (VİDALI)	TWO GANG TWO WAY SWITCH (COMMUTATOR VEAVIEN)
2270 405 02XX	ÇİFT KUTUPLU ANAHTAR (VİDALI)	DOUBLE POLE SWITCH
2270 406 02XX	JALUZİ ANAHTARI-YAYLI (VİDALI)	BLIND SWITCH (CONTROL SWITCH)
2270 407 02XX	ÇAĞIRMA (LİGHT) (VİDALI)	ONE GANG ONE WAY SWITCH (LIGHT) (PUSH Plate)
2270 407 02XXK	KAPI OTOMATIĞI ANAHTARI (VİDALI)	DOOR SWITCH
2270 407 02XXZ	ZİL ANAHTARI (VİDALI)	BELL SWITCH
2270 408 02XX	DEVİATÖR (ARA VAVİEN) (VİDALI)	ONE GANG INTERMEDIATE SWITCH
2270 409 02XX	ÜÇLÜ ANAHTAR (VİDALI)	THREE GANG ONE WAY SWITCH
2270 411 02XX	ŞOFBEN ANAHTARI (VİDALI)	HEATER SWITCH
2270 415 02XX	İŞIKLI ANAHTAR (220V) (VİDALI)	ILLUMINATED ONE (220V)GANG ONE WAY SWITCH
2270 416 02XX	İŞIKLI VAVİEN (220V) (VİDALI)	ILLUMINATED ONE GANG TWO WAY
2270 417 02XX	İŞIKLI ÇAĞIRMA(220V) (VİDALI)	ILLUMINATED ONE GANG ONE WAY (PUSH Plate) SWITCH)
2270 418 02XX	İŞIKLI ETİKETLİ ANAHTAR (220V) (VİDALI)	ILLUMINATED 1 G 1 W SWITCH WITH LABEL
2270 419 02XX	İŞIKLI ETİKETLİ ÇAĞIRMA (220V) (VİDALI)	ILLUMINATED 1 G 1 W SWITCH WITH LABEL (PUSH Plate)
2270 422 02XX	İŞIKLI ZİL ÇAĞIRMA (12V) (VİDALI)	ILLUMINATED ONE GANG ONE WAY SWITCH (PUSH Plate)
2270 426 02XX	İŞIKLI KOMÜTATÖR (VİDALI)	ILLUMINATED TWO GANG ONE WAY SWITCH (220V)
ANAHTAR GRUBU KLİPSLİ		SWITCH GROUP EASY CONNECTION
2270 401 01XX	ANAHTAR (KLİPSLİ)	ONE GANG ONE WAY SWITCH
2270 402 01XX	KOMÜTATÖR (KLİPSLİ)	TWO GANG ONE WAY SWITCH
2270 403 01XX	VAVİEN (İKİ YOLLU ANAHTAR) (KLİPSLİ)	ONE GANG TWO WAY SWITCH (VA-ET-VIENT)
2270 404 01XX	KOMÜTATÖR VAVİEN (KLİPSLİ)	TWO GANG TWO WAY SWITCH (COMMUTATOR VEAVIEN)
2270 405 01XX	ÇİFT KUTUPLU ANAHTAR (KLİPSLİ)	DOUBLE POLE SWITCH
2270 406 01XX	JALUZİ ANAHTARI-YAYLI (KLİPSLİ)	BLIND SWITCH (CONTROL SWITCH)
2270 407 01XX	ÇAĞIRMA (LİGHT) (KLİPSLİ)	ONE GANG ONE WAY SWITCH (LIGHT) (PUSH Plate)
2270 407 01XXK	KAPI OTOMATIĞI ANAHTARI (KLİPSLİ)	DOOR SWITCH
2270 407 01XXZ	ZİL ANAHTARI (KLİPSLİ)	BELL SWITCH
2270 408 01XX	DEVİATÖR (ARA VAVİEN) (KLİPSLİ)	ONE GANG INTERMEDIATE SWITCH
2270 409 01XX	ÜÇLÜ ANAHTAR (KLİPSLİ)	THREE GANG ONE WAY SWITCH
2270 415 01XX	İŞIKLI ANAHTAR (220V) (KLİPSLİ)	ILLUMINATED ONE (220V)GANG ONE WAY SWITCH
2270 416 01XX	İŞIKLI VAVİEN (220V) (KLİPSLİ)	ILLUMINATED ONE GANG TWO WAY
2270 417 01XX	İŞIKLI ÇAĞIRMA(220V) (KLİPSLİ)	ILLUMINATED ONE GANG ONE WAY (PUSH Plate) SWITCH)
2270 418 01XX	İŞIKLI ETİKETLİ ANAHTAR (220V) (KLİPSLİ)	ILLUMINATED 1 G 1 W SWITCH WITH LABEL
2270 419 01XX	İŞIKLI ETİKETLİ ÇAĞIRMA (220V) (KLİPSLİ)	ILLUMINATED 1 G 1 W SWITCH WITH LABEL (PUSH Plate)
2270 422 01XX	İŞIKLI ZİL ÇAĞIRMA (12V) (KLİPSLİ)	ILLUMINATED ONE GANG ONE WAY SWITCH (PUSH Plate)
2270 426 01XX	İŞIKLI KOMÜTATÖR (KLİPSLİ)	ILLUMINATED TWO GANG ONE WAY SWITCH (220V)

MEKANİZMA + TUŞ ÜRÜN LİSTESİ • MECHANISM + PLATE PRODUCT LIST

Kod / Code	Ürün Tanımı	Description
DİMMER GRUBU		DIMMER GROUP
	İŞIKLI DİMMER (600 W)	RL ILLUMINATED DIMMER (600 W)
2270 440 02XX	İŞIKLI DİMMER CE'Lİ (600 W) FİLTRELİ	RL ILLUMINATED DIMMER (600 W CE)
2270 443 02XX	İŞIKLI DİMMER (1000 W)	RL ILLUMINATED DIMMER (1000 W)
2270 444 02XX	RLC DİMMER (10-300W)	RLC DIMMER (10-300W)
2270 445 02XX		
ELEKTRONİK GRUBU		ELECTRONIC GROUP
2270 450 02XX	ENERGY SAVER GECİKMESİZ İŞIKLI	ENERGY SAVER ILLUMINATED
2270 452 02XX	ENERGY SAVER GECİKME Lİ İŞIKLI	ENERGY SAVER WITH DELAY
2270 470 02XX	MÜZİK YAYIN ANAHTARI	AUDIO SWITCH
2270 480 02XX	HOPARLÖR PRİZİ	SPEAKER SOCKET
2270 485 02XX	UYARI ZİLİ	WARNING SWITCH
2270 495 02XX	HAREKET SENSÖRÜ	MOVEMENT SENSOR
PRİZ GRUBU		SOCKET GROUP
2270 600 02XX	TOPRAKLI PRİZ	EARTHED SOCKET OUTLET
2270 601 02XX	TOPRAKSIZ PRİZ	SOCKET OUTLET NON- EARTHED
2270 605 02XX	TOPRAKLI PRİZ (ÇOCUK KORUMALI)	EARTHED SOCKET WITH CHILD PROTECTION
2270 606 02XX	TOPRAKSIZ PRİZ (ÇOCUK KORUMALI)	SOCKET OUTLET WITH CHILD PROTECTION NON EARTHED
2270 610 02XX	KAPAKLI TOPRAKLI PRİZ	EARTHED SOCKET WITH COVER
2270 611 02XX	KAPAKLI TOPRAKLI PRİZ (ÇOCUK KORUMALI)	EARTHED SOCKET WITH CHILD PROTECTION WITH COVER
2270 615 02XX	UPS (FRANSIZ) PRİZİ	UPS (FRENCH) SOCKET (EARTHED SOCKET WITH PIN)
2270 616 02XX	UPS (FRANSIZ) PRİZİ (ÇOCUK KORUMALI)	UPS (FRENCH) SOCKET (CHILD PROTECTION)
2270 617 02XX	UPS KAPAKLI(FRANSIZ) PRİZİ	UPS SOCKET (FRENCH) WITH COVER
2270 618 02XX	UPS (FRANSIZ)KAP. TOPRAKLI PRİZ (ÇOC.KRM)	UPS SOCKET (FRENCH) CHILD PROTECTION WITH COVER
2270 448 02XX	TEKLİ USB ŞARJ PRİZİ	USB CHARGE SOCKET
2270 449 02XX	İKİLİ USB ŞARJ PRİZİ	USB CHARGE TWO SOCKET
İLETİŞİM GRUBU		COMMUNICATIONS GROUP
2270 125 01XX	TELEFON PRİZİ 1*RJ12 (CAT 3)	TELEPHONE SOCKET 1*RJ12 (CAT 3)
2270 126 01XX	TELEFON PRİZİ 2*RJ12 (CAT 3)	TELEPHONE SOCKET 2*RJ12 (CAT 3)
2270 128 01XX	ETİKETLİ TELEFON DATA PRİZ (KON.SÜZ)	TELEPHONE DATA SOCKET WITH LABEL (WITHOUT CONNECTOR)
2270 135 02XX	DATA PRİZ 1*RJ45 (KONNEKTÖRSÜZ)	DATA SOCKET 1*RJ45 (WITHOUT CONNECTOR)
2270 136 01XX	DATA PRİZ 1*RJ45 (CAT 5E)	DATA SOCKET 1*RJ45 (CAT 5E)
2270 137 01XX	DATA PRİZ 2*RJ45 (KONNEKTÖRSÜZ)	DATA SOCKET 2*RJ45 (WITHOUT CONNECTOR)
2270 138 01XX	DATA PRİZ 2*RJ45 (CAT 5E)	DATA SOCKET 2*RJ45 (CAT 5E)
2270 139 01XX	DATA PRİZ (RJ12 CAT 3+CAT 5 E)	DATA SOCKET (RJ12 CAT 3+CAT 5 E)
2270 140 01XX	DATA PRİZ 1*RJ45 (CAT 6)	DATA SOCKET 1*RJ45 (CAT 6)
2270 141 01XX	DATA PRİZ 2*RJ45 (CAT 6)	DATA SOCKET 2*RJ45 (CAT 6)
2270 455 01XX	DATA PRİZ 1*USB	DATA SOCKET 1* USB
2270 456 01XX	DATA PRİZ 2*USB	DATA SOCKET 2* USB
2270 457 01XX	DATA PRİZ 1*HDMI	DATA SOCKET 1*HDMI
2270 458 01XX	DATA PRİZ 2*HDMI	DATA SOCKET 2*HDMI
459 01XX	DATA PRİZ 1*USB / 1*HDMI	DATA SOCKET 1*USB / 1*HDMI
2270 460 01XX	VGA PRİZ	VGA SOCKET
2270 121 02XX	KÖR KAPAK	BLIND COVER
TV / SAT GRUBU		TV / SAT GROUP
2270 156 02XX	TV / SAT PRİZİ (GEÇİŞLİ) 4DB/F KON.	TV / SAT SOCKET (THROUGH) 4DB/F CON.
2270 157 02XX	TV / SAT PRİZİ (SONLU)	TV / SAT SOCKET (DEAD-END)
2270 166 01XX	SAT PRİZİ (GEÇİŞLİ) 4DB/F KON.	SAT SOCKET (THROUGH)
2270 167 01XX	SAT PRİZİ (SONLU)	SAT SOCKET (DEAD-END)
2270 170 01XX	TV PRİZİ (GEÇİŞLİ) 11 DB	TV SOCKET (THROUGH) 11 DB
2270 171 01XX	TV PRİZİ (SONLU)	TV SOCKET (DEAD-END)
2270 172 01XX	TV PRİZİ F DİŞİ	TV SOCKET F FEMALE
SIVA ÜSTÜ KASA		SURFACE BOX
2100 000 11XX	SIVA ÜSTÜ KASA	SURFACE MOUNTED BOX

Candela

SERİSİ
SERIES



Şık çözümler...

Zarif ve ince çizgileriyle konforunuzu artıran, şıklığınızı tamamlayan çözümler geliştirdik.

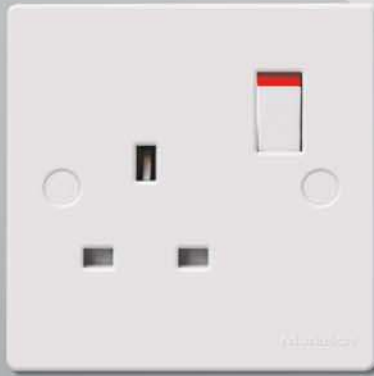

Metallic

METALİK • METALLIC



Elegant solutions ...

We have developed solutions that enhance comfort with elegant and subtle lines, complementing your elegance...

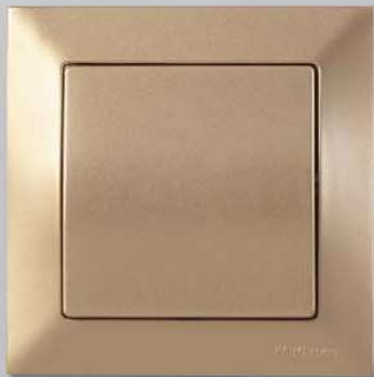

Candela

SERİSİ
SERIES



Mekanınızla uyumlu...

Dekorasyonunuzu bütünleyen şık görünümü tamamlayan ustaca dokunuşlar.

Compatible with your place...

The masterful touches that complement the elegant look that completes your decoration.





Will color your
children's room

Shifting different from day to night...



Genç ve çocuk
odalarını renklendirecek,

Gece farklı gündüz farklı değişen desenli...



2127 510 01 XX
TRAFFIC



2127 510 02 XX
TRAIN



2127 514 01 XX
CARETTA



2127 516 01 XX
BALLOON



2127 518 01 XX
DOLPHIN



2127 520 01 XX
SEA HORSE



2127 522 01 XX
LOVE



2127 524 01 XX
COW



2127 526 01 XX
CARUSEL



2127 528 01 XX
DIVER

Candelä

ÇERÇEVELER
FRAMES

ÇERÇEVELER

Tekliden altılıya kadar çoklu anahtar ihtiyaçlarınızın çözümü...

FRAMES

Multi-key solution for your needs from single up to six...

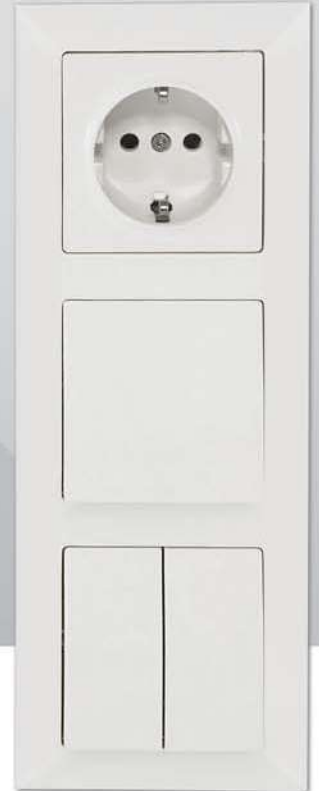
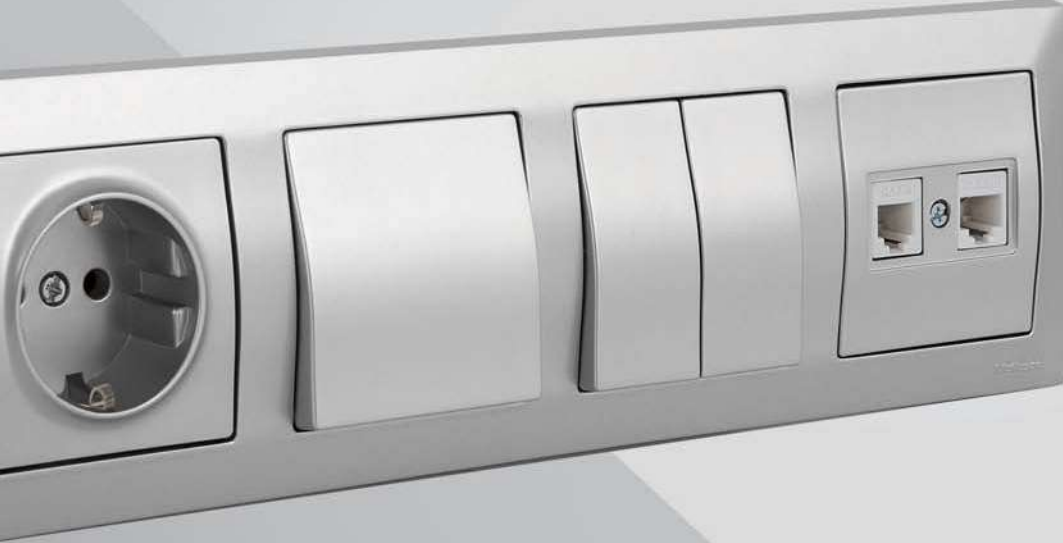

RENK SEÇENEKLERİ COLORS OPTIONS

NATUREL • NATURAL



XX : 01 Beyaz • White



XX : 02 Krem • Ivory

METALİK • METALLIC



XX : 80
Antik altın • Antique gold



XX : 82
İnoks • Inox



XX : 83
Titanyum • Titanium



XX : 84
Siyah • Black



XX : 95
Füme • Smoked

AHŞAP DESEN • WOOD PATTERN



XX : 56 Kiraz • Cherry



XX : 57 Ceviz • Walnuts



XX : 58 Meşe • Oak

CANDELA KIDS



XX : 01 Beyaz • White



XX : 11 Pembe • Pink



XX : 12 Mavi • Blue

YATAY ÇERÇEVELER • HORIZONTAL FRAMES

2125 800 11 XX
1'li Çerçeve • 1 Gang frame



2125 800 12 XX
2'li Çerçeve • 2 Gang frame



2125 800 13 XX
3'lü Çerçeve • 3 Gang frame



2125 800 14 XX
4'lü Çerçeve • 4 Gang frame



2125 800 15 XX
5'li Çerçeve • 5 Gang frame



2125 800 16 XX
6'li Çerçeve • 6 Gang frame



DİKEY ÇERÇEVELER • VERTICAL FRAMES

2125 800 22 XX
2'li Çerçeve
2 Gang frame



2125 800 23 XX
3'lü Çerçeve
3 Gang frame



2125 800 24 XX
4'lü Çerçeve
4 Gang frame

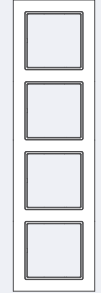

2125 800 25 XX
5'li Çerçeve
5 Gang frame



2125 800 26 XX
6'li Çerçeve
6 Gang frame



Bu ürün kodlarında XX çerçeve rengini belirtmektedir.
XX specify frame color for these products.

Candela

TEKNİK BİLGİLER
TECHNICAL FEATURES

BOYUTLAR • DIMENSIONS

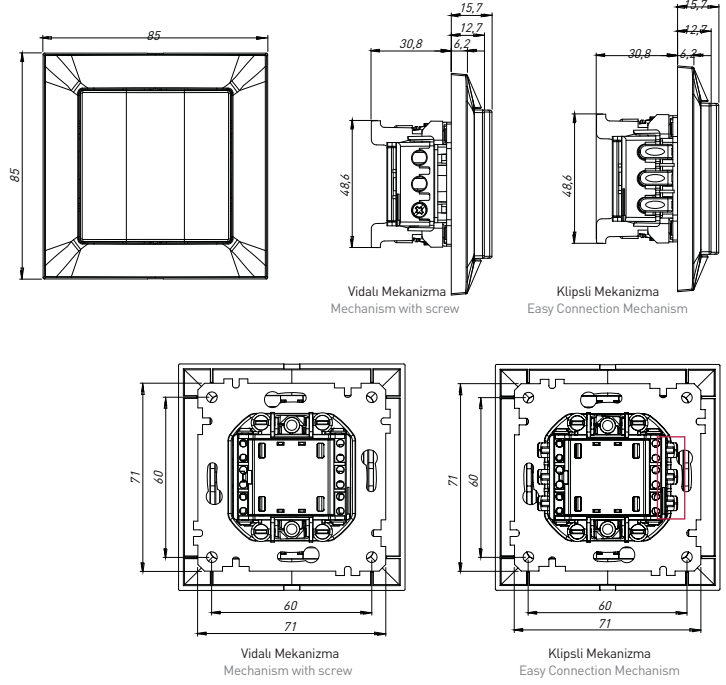

MEKANİZMA + TUŞ ÜRÜN LİSTESİ • MECHANISM + PLATE PRODUCT LIST

Kod / Code	Ürün Tanımı	Description
ANAHTAR GRUBU VİDALI		
2100 401 02XX	ANAHTAR (VİDALI)	ONE GANG ONE WAY SWITCH
2100 402 02XX	KOMÜTATÖR (VİDALI)	TWO GANG ONE WAY SWITCH
2100 403 02XX	VAVİEN(İKİ YOLLU ANAHTAR) (VİDALI)	ONE GANG TWO WAY SWITCH (VA-ET-VIENT)
2100 404 02XX	KOMÜTATÖR VAVİEN (VİDALI)	TWO GANG TWO WAY SWITCH (COMMUTATOR VEAVIEN)
2100 405 02XX	ÇİFT KUTUPLU ANAHTAR (VİDALI)	DOUBLE POLE SWITCH
2100 406 02XX	JALUZİ ANAHTARI-YAYLI (VİDALI)	BLIND SWITCH (CONTROL SWITCH)
2100 407 02XX	ÇAĞIRMA (LİGH) (VİDALI)	ONE GANG ONE WAY SWITCH (LIGHT) (PUSH Plate)
2100 407 02XXK	KAPI OTOMATIĞI ANAHTARI (VİDALI)	DOOR SWITCH
2100 407 02XXZ	ZİL ANAHTARI (VİDALI)	BELL SWITCH
2100 408 02XX	DEVİATÖR (ARA VAVİEN) (VİDALI)	ONE GANG INTERMEDIATE SWITCH
2100 409 02XX	ÜÇLÜ ANAHTAR (VİDALI)	THREE GANG ONE WAY SWITCH
2100 411 02XX	ŞOFBEN ANAHTARI (VİDALI)	HEATER SWITCH
2100 415 02XX	İŞIKLI ANAHTAR (220V) (VİDALI)	ILLUMINATED ONE (220V)GANG ONE WAY SWITCH
2100 416 02XX	İŞIKLI VAVİEN (220V) (VİDALI)	ILLUMINATED ONE GANG TWO WAY
2100 417 02XX	İŞIKLI ÇAĞIRMA(220V) (VİDALI)	ILLUMINATED ONE GANG ONE WAY (PUSH Plate) SWITCH)
2100 418 02XX	İŞIKLI ETİKETLİ ANAHTAR (220V) (VİDALI)	ILLUMINATED 1 G 1 W SWITCH WITH LABEL
2100 419 02XX	İŞIKLI ETİKETLİ ÇAĞIRMA (220V) (VİDALI)	ILLUMINATED 1 G 1 W SWITCH WITH LABEL (PUSH Plate)
2100 422 02XX	İŞIKLI ZİL ÇAĞIRMA (12V) (VİDALI)	ILLUMINATED ONE GANG ONE WAY SWITCH (PUSH Plate)
2100 426 02XX	İŞIKLI KOMÜTATÖR (VİDALI)	ILLUMINATED TWO GANG ONE WAY SWITCH (220V)

ANAHTAR GRUBU KLİPSLİ		
2100 401 01XX	ANAHTAR (KLİPSLİ)	ONE GANG ONE WAY SWITCH
2100 402 01XX	KOMÜTATÖR (KLİPSLİ)	TWO GANG ONE WAY SWITCH
2100 403 01XX	VAVİEN(İKİ YOLLU ANAHTAR) (KLİPSLİ)	ONE GANG TWO WAY SWITCH (VA-ET-VIENT)
2100 404 01XX	KOMÜTATÖR VAVİEN (KLİPSLİ)	TWO GANG TWO WAY SWITCH (COMMUTATOR VEAVIEN)
2100 405 01XX	ÇİFT KUTUPLU ANAHTAR (KLİPSLİ)	DOUBLE POLE SWITCH
2100 406 01XX	JALUZİ ANAHTARI-YAYLI (KLİPSLİ)	BLIND SWITCH (CONTROL SWITCH)
2100 407 01XX	ÇAĞIRMA (LİGH) (KLİPSLİ)	ONE GANG ONE WAY SWITCH (LIGHT) (PUSH Plate)
2100 407 01XXK	KAPI OTOMATIĞI ANAHTARI (KLİPSLİ)	DOOR SWITCH
2100 407 01XXZ	ZİL ANAHTARI (KLİPSLİ)	BELL SWITCH
2100 408 01XX	DEVİATÖR (ARA VAVİEN) (KLİPSLİ)	ONE GANG INTERMEDIATE SWITCH
2100 409 01XX	ÜÇLÜ ANAHTAR (KLİPSLİ)	THREE GANG ONE WAY SWITCH
2100 415 01XX	İŞIKLI ANAHTAR (220V) (KLİPSLİ)	ILLUMINATED ONE (220V)GANG ONE WAY SWITCH
2100 416 01XX	İŞIKLI VAVİEN (220V) (KLİPSLİ)	ILLUMINATED ONE GANG TWO WAY
2100 417 01XX	İŞIKLI ÇAĞIRMA(220V) (KLİPSLİ)	ILLUMINATED ONE GANG ONE WAY (PUSH Plate) SWITCH)
2100 418 01XX	İŞIKLI ETİKETLİ ANAHTAR (220V) (KLİPSLİ)	ILLUMINATED 1 G 1 W SWITCH WITH LABEL
2100 419 01XX	İŞIKLI ETİKETLİ ÇAĞIRMA (220V) (KLİPSLİ)	ILLUMINATED 1 G 1 W SWITCH WITH LABEL (PUSH Plate)
2100 422 01XX	İŞIKLI ZİL ÇAĞIRMA (12V) (KLİPSLİ)	ILLUMINATED ONE GANG ONE WAY SWITCH (PUSH Plate)
2100 426 01XX	İŞIKLI KOMÜTATÖR (KLİPSLİ)	ILLUMINATED TWO GANG ONE WAY SWITCH (220V)

MEKANİZMA + TUŞ ÜRÜN LİSTESİ • MECHANISM + PLATE PRODUCT LIST

Kod / Code	Ürün Tanımı	Description
DİMMER GRUBU		DIMMER GROUP
2100 440 02XX	IŞIKLI DİMMER (600 W)	RL ILLUMINATED DIMMER (600 W)
2100 443 02XX	IŞIKLI DİMMER CE'LI (600 W) FİLTRELİ	RL ILLUMINATED DIMMER (600 W CE)
2100 444 02XX	IŞIKLI DİMMER (1000 W)	RL ILLUMINATED DIMMER (1000 W)
2100 445 02XX	RLC DİMMER (10-300W)	RLC DIMMER (10-300W)
ELEKTRONİK GRUBU		ELECTRONIC GROUP
2100 450 02XX	ENERGY SAVER GECİKMEŞİZ IŞIKLI	ENERGY SAVER ILLUMINATED
2100 452 02XX	ENERGY SAVER GECİKMELİ IŞIKLI	ENERGY SAVER WITH DELAY
2100 470 02XX	MÜZİK YAYIN ANAHTARI	AUDIO SWITCH
2100 480 02XX	HOPARLÖR PRİZİ	SPEAKER SOCKET
2100 485 02XX	UYARI ZİLİ	WARNING SWITCH
2100 495 02XX	HAREKET SENSÖRÜ	MOVEMENT SENSOR
PRİZ GRUBU		SOCKET GROUP
2100 600 02XX	TOPRAKLI PRİZ	EARTHED SOCKET OUTLET
2100 601 02XX	TOPRAKSIZ PRİZ	SOCKET OUTLET NON- EARTHED
2100 605 02XX	TOPRAKLI PRİZ (ÇOCUK KORUMALI)	EARTHED SOCKET WITH CHILD PROTECTION
2100 606 02XX	TOPRAKSIZ PRİZ (ÇOCUK KORUMALI)	SOCKET OUTLET WITH CHILD PROTECTION NON EARTHED
2100 610 02XX	KAPAKLI TOPRAKLI PRİZ	EARTHED SOCKET WITH COVER
2100 611 02XX	KAPAKLI TOPRAKLI PRİZ (ÇOCUK KORUMALI)	EARTHED SOCKET WITH CHILD PROTECTION COVER
2100 615 02XX	UPS (FRANSIZ) PRİZİ	UPS (FRENCH) SOCKET (EARTHED SOCKET WITH PIN)
2100 616 02XX	UPS (FRANSIZ) PRİZİ (ÇOCUK KORUMALI)	UPS (FRENCH) SOCKET (CHILD PROTECTION)
2100 617 02XX	UPS KAPAKLI(FRANSIZ) PRİZİ	UPS SOCKET (FRENCH) WITH COVER
2100 618 02XX	UPS (FRANSIZ)KAP. TOPRAKLI PRİZ (ÇOC.KRM)	UPS SOCKET (FRENCH) WITH COVER (CHILD PROTECTION)
2100 200 02XX	İKİLİ TOPRAKLI PRİZ (PORSELEN)	DOUBLE SOCKET EARTHED PORCELAIN
2100 201 02XX	İKİLİ TOPRAKSIZ PRİZ (PORSELEN)	DOUBLE SOCKET (NON EARTHED) PORCELAIN
2100 202 02XX	İKİLİ TOPRAKLI PRİZ	DOUBLE SOCKET EARTHED
2100 203 02XX	İKİLİ TOPRAKSIZ PRİZ	DOUBLE SOCKET (NON EARTHED)
2100 215 01XX	İKİLİ UPS PRİZ	DOUBLE SOCKET WITH UPS (FRENCH)
2100 448 02XX	TEKLİ USB ŞARJ PRİZİ	USB CHARGE SOCKET
2100 449 02XX	İKİLİ USB ŞARJ PRİZİ	USB CHARGE TWO SOCKET
İLETİŞİM GRUBU		COMMUNICATIONS GROUP
2100 125 01XX	TELEFON PRİZİ 1*RJ12 (CAT 3)	TELEPHONE SOCKET 1*RJ12 (CAT 3)
2100 126 01XX	TELEFON PRİZİ 2*RJ12 (CAT 3)	TELEPHONE SOCKET 2*RJ12 (CAT 3)
2100 128 01XX	ETİKETLİ TELEFON DATA PRİZ (KON.SÜZ)	TELEPHONE DATA SOCKET WITH LABEL (WITHOUT CONNECTOR)
2100 135 02XX	DATA PRİZ 1*RJ45 (KONNEKTÖRSÜZ)	DATA SOCKET 1*RJ45 (WITHOUT CONNECTOR)
2100 136 01XX	DATA PRİZ 1*RJ45 (CAT 5E)	DATA SOCKET 1*RJ45 (CAT 5E)
2100 137 01XX	DATA PRİZ 2*RJ45 (KONNEKTÖRSÜZ)	DATA SOCKET 2*RJ45 (WITHOUT CONNECTOR)
2100 138 01XX	DATA PRİZ 2*RJ45 (CAT 5E)	DATA SOCKET 2*RJ45 (CAT 5E)
2100 139 01XX	DATA PRİZ (RJ12 CAT 3+CAT 5 E)	DATA SOCKET (RJ12 CAT 3+CAT 5 E)
2100 140 01XX	DATA PRİZ 1*RJ45 (CAT 6)	DATA SOCKET 1*RJ45 (CAT 6)
2100 141 01XX	DATA PRİZ 2*RJ45 (CAT 6)	DATA SOCKET 2*RJ45 (CAT 6)
2100 455 01XX	DATA PRİZ 1*USB	DATA SOCKET 1* USB
2100 456 01XX	DATA PRİZ 2*USB	DATA SOCKET 2* USB
2100 457 01XX	DATA PRİZ 1*HDMI	DATA SOCKET 1*HDMI
2100 458 01XX	DATA PRİZ 2*HDMI	DATA SOCKET 2*HDMI
01XX	DATA PRİZ 1*USB / 1*HDMI	DATA SOCKET 1*USB / 1*HDMI
2100 460 01XX	VGA PRİZ	VGA SOCKET
2100 121 02XX	KÖR KAPAK	BLIND COVER
TV / SAT GRUBU		TV / SAT GROUP
2100 156 02XX	TV / SAT PRİZİ (GEÇİŞLİ) 4DB/F KON.	TV / SAT SOCKET (THROUGH) 4DB/F CON.
2100 157 02XX	TV / SAT PRİZİ (SONLU)	TV / SAT SOCKET (DEAD-END)
2100 166 01XX	SAT PRİZİ (GEÇİŞLİ) 4DB/F KON.	SAT SOCKET (THROUGH)
2100 167 01XX	SAT PRİZİ (SONLU)	SAT SOCKET (DEAD-END)
2100 170 01XX	TV PRİZİ (GEÇİŞLİ) 11 DB	TV SOCKET (THROUGH) 11 DB
2100 171 01XX	TV PRİZİ (SONLU)	TV SOCKET (DEAD-END)
2100 172 01XX	TV PRİZİ F DIŞI	TV SOCKET F FEMALE
2190 500 02XX	İNGİLİZ TİP ANAHTAR PRİZ	
SIVA ÜSTÜ KASA		SURFACE BOX
2100 000 11XX	SIVA ÜSTÜ KASA	SURFACE MOUNTED BOX

Daria
SERİSİ
SERIES



Mutlu anlarınıza şahitlik edecek...

Kendi dünyanızı yaratın, bulunduğunuz mekandan keyif alın diye ürettik..



Metallic

METALİK • METALLIC



Witness to your happy moments ...

We create for you to create your own world,
to enjoy your places...



Daria
SERİSİ
SERIES



Doğallığı zarafetle harmanladık ...

Farklı tarzları harmanlayan bir tasarım anlayışı odanızda hayat bulsun...

We blended the naturalness and elegance ...

An understanding of design that blends different styles energise in your room...



ÇERÇEVELER FRAMES



RENK SEÇENEKLERİ COLORS OPTIONS

NATUREL • NATURAL



XX : 01 Beyaz • White



XX : 02 Krem • Ivory

METALİK • METALLIC



XX : 80
Antik altın • Antique gold



XX : 82
İnoks • Inox



XX : 83
Titanyum • Titanium



XX : 84
Siyah • Black



XX : 95
Füme • Smoked

AHŞAP DESEN • WOOD PATTERN



XX : 56 Kiraz • Cherry



XX : 57 Ceviz • Walnuts



XX : 58 Meşe • Oak

YATAY ÇERÇEVELER • HORIZONTAL FRAMES

2120 800 11 XX
1'li Çerçeve • 1 Gang frame



2120 800 12 XX
2'li Çerçeve • 2 Gang frame



2120 800 13 XX
3'lü Çerçeve • 3 Gang frame



2120 800 14 XX
4'lü Çerçeve • 4 Gang frame



2120 800 15 XX
5'li Çerçeve • 5 Gang frame



DIKEY ÇERÇEVELER • VERTICAL FRAMES

2120 800 22 XX
2'li Çerçeve
2 Gang frame



2120 800 23 XX
3'lü Çerçeve
3 Gang frame



2120 800 24 XX
4'lü Çerçeve
4 Gang frame



2120 800 25 XX
5'li Çerçeve
5 Gang frame



Bu ürün kodlarında XX çerçeve rengini belirtmektedir.
XX specify frame color for these products.

Daria

TEKNİK BİLGİLER
TECHNICAL FEATURES

BOYUTLAR • DIMENSIONS

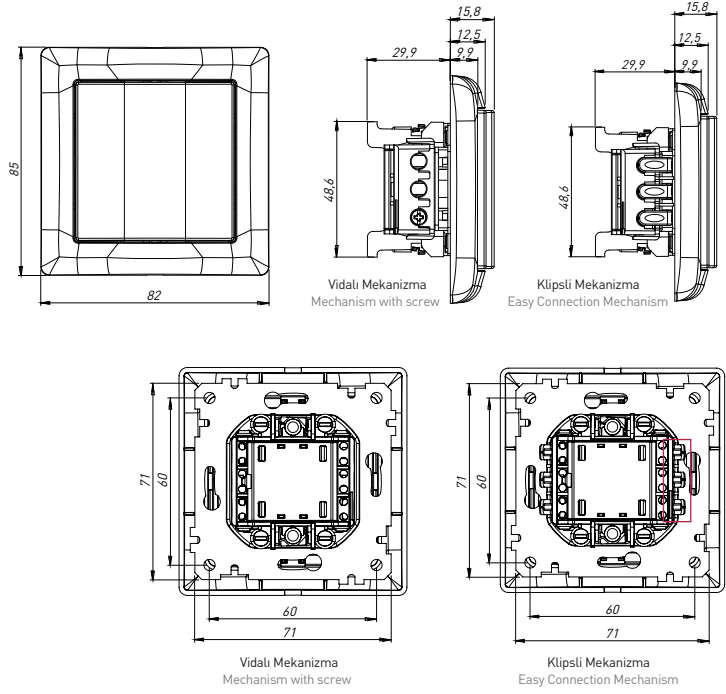

MEKANİZMA + TUŞ ÜRÜN LİSTESİ • MECHANISM + PLATE PRODUCT LIST

Kod / Code	Ürün Tanımı	Description
ANAHTAR GRUBU VİDALI		
2100 401 02XX	ANAHTAR (VİDALI)	ONE GANG ONE WAY SWITCH
2100 402 02XX	KOMÜTATÖR (VİDALI)	TWO GANG ONE WAY SWITCH
2100 403 02XX	VAVİEN (İKİ YOLLU ANAHTAR) (VİDALI)	ONE GANG TWO WAY SWITCH (VA-ET-VIENT)
2100 404 02XX	KOMÜTATÖR VAVİEN (VİDALI)	TWO GANG TWO WAY SWITCH (COMMUTATOR VEAVIEN)
2100 405 02XX	ÇİFT KUTUPLU ANAHTAR (VİDALI)	DOUBLE POLE SWITCH
2100 406 02XX	JALUZİ ANAHTARI-YAYLI (VİDALI)	BLIND SWITCH (CONTROL SWITCH)
2100 407 02XX	ÇAĞIRMA (LIGHT) (VİDALI)	ONE GANG ONE WAY SWITCH (LIGHT) (PUSH Plate)
2100 407 02XXK	KAPI OTOMATİĞİ ANAHTARI (VİDALI)	DOOR SWITCH
2100 407 02XXZ	ZİL ANAHTARI (VİDALI)	BELL SWITCH
2100 408 02XX	DEVİYATÖR (ARA VAVİEN) (VİDALI)	ONE GANG INTERMEDIATE SWITCH
2100 409 02XX	ÜÇLÜ ANAHTAR (VİDALI)	THREE GANG ONE WAY SWITCH
2100 411 02XX	ŞOFBEN ANAHTARI (VİDALI)	HEATER SWITCH
2100 415 02XX	IŞIKLI ANAHTAR (220V) (VİDALI)	ILLUMINATED ONE (220V)GANG ONE WAY SWITCH
2100 416 02XX	IŞIKLI VAVİEN (220V) (VİDALI)	ILLUMINATED ONE GANG TWO WAY
2100 417 02XX	IŞIKLI ÇAĞIRMA(220V) (VİDALI)	ILLUMINATED ONE GANG ONE WAY (PUSH Plate) SWITCH)
2100 418 02XX	IŞIKLI ETİKETLİ ANAHTAR (220V) (VİDALI)	ILLUMINATED 1 G 1 W SWITCH WITH LABEL
2100 419 02XX	IŞIKLI ETİKETLİ ÇAĞIRMA (220V) (VİDALI)	ILLUMINATED 1 G 1 W SWITCH WITH LABEL (PUSH Plate)
2100 422 02XX	IŞIKLI ZİL ÇAĞIRMA (12V) (VİDALI)	ILLUMINATED ONE GANG ONE WAY SWITCH (PUSH Plate)
2100 426 02XX	IŞIKLI KOMÜTATÖR (VİDALI)	ILLUMINATED TWO GANG ONE WAY SWITCH (220V)

ANAHTAR GRUBU KLİPSLİ		
SWITCH GROUP EASY CONNECTION		
2100 401 01XX	ANAHTAR (KLİPSLİ)	ONE GANG ONE WAY SWITCH
2100 402 01XX	KOMÜTATÖR (KLİPSLİ)	TWO GANG ONE WAY SWITCH
2100 403 01XX	VAVİEN (İKİ YOLLU ANAHTAR) (KLİPSLİ)	ONE GANG TWO WAY SWITCH (VA-ET-VIENT)
2100 404 01XX	KOMÜTATÖR VAVİEN (KLİPSLİ)	TWO GANG TWO WAY SWITCH (COMMUTATOR VEAVIEN)
2100 405 01XX	ÇİFT KUTUPLU ANAHTAR (KLİPSLİ)	DOUBLE POLE SWITCH
2100 406 01XX	JALUZİ ANAHTARI-YAYLI (KLİPSLİ)	BLIND SWITCH (CONTROL SWITCH)
2100 407 01XX	ÇAĞIRMA (LIGHT) (KLİPSLİ)	ONE GANG ONE WAY SWITCH (LIGHT) (PUSH Plate)
2100 407 01XXK	KAPI OTOMATİĞİ ANAHTARI (KLİPSLİ)	DOOR SWITCH
2100 407 01XXZ	ZİL ANAHTARI (KLİPSLİ)	BELL SWITCH
2100 408 01XX	DEVİYATÖR (ARA VAVİEN) (KLİPSLİ)	ONE GANG INTERMEDIATE SWITCH
2100 409 01XX	ÜÇLÜ ANAHTAR (KLİPSLİ)	THREE GANG ONE WAY SWITCH
2100 415 01XX	IŞIKLI ANAHTAR (220V) (KLİPSLİ)	ILLUMINATED ONE (220V)GANG ONE WAY SWITCH
2100 416 01XX	IŞIKLI VAVİEN (220V) (KLİPSLİ)	ILLUMINATED ONE GANG TWO WAY
2100 417 01XX	IŞIKLI ÇAĞIRMA(220V) (KLİPSLİ)	ILLUMINATED ONE GANG ONE WAY (PUSH Plate) SWITCH)
2100 418 01XX	IŞIKLI ETİKETLİ ANAHTAR (220V) (KLİPSLİ)	ILLUMINATED 1 G 1 W SWITCH WITH LABEL
2100 419 01XX	IŞIKLI ETİKETLİ ÇAĞIRMA (220V) (KLİPSLİ)	ILLUMINATED 1 G 1 W SWITCH WITH LABEL (PUSH Plate)
2100 422 01XX	IŞIKLI ZİL ÇAĞIRMA (12V) (KLİPSLİ)	ILLUMINATED ONE GANG ONE WAY SWITCH (PUSH Plate)
2100 426 01XX	IŞIKLI KOMÜTATÖR (KLİPSLİ)	ILLUMINATED TWO GANG ONE WAY SWITCH (220V)

MEKANİZMA + TUŞ ÜRÜN LİSTESİ • MECHANISM + PLATE PRODUCT LIST

Kod / Code	Ürün Tanımı	Description
DİMMER GRUBU		DIMMER GROUP
2100 440 02XX	IŞIKLI DİMMER (600 W)	RL ILLUMINATED DIMMER (600 W)
2100 443 02XX	IŞIKLI DİMMER CE'Li (600 W) FİLTRELİ	RL ILLUMINATED DIMMER (600 W CE)
2100 444 02XX	IŞIKLI DİMMER (1000 W)	RL ILLUMINATED DIMMER (1000 W)
2100 445 02XX	RLC DİMMER (10-300W)	RLC DIMMER (10-300W)
ELEKTRONİK GRUBU		ELECTRONIC GROUP
2100 450 02XX	ENERGY SAVER GECİKMESİZ IŞIKLI	ENERGY SAVER ILLUMINATED
2100 452 02XX	ENERGY SAVER GECİKMELİ IŞIKLI	ENERGY SAVER WITH DELAY
2100 470 02XX	MÜZİK YAYIN ANAHTARI	AUDIO SWITCH
2100 480 02XX	HOPARLÖR PRİZİ	SPEAKER SOCKET
2100 485 02XX	UYARI ZİLİ	WARNING SWITCH
2100 495 02XX	HAREKET SENSÖRÜ	MOVEMENT SENSOR
PRİZ GRUBU		SOCKET GROUP
2100 600 02XX	TOPRAKLI PRİZ	EARTHED SOCKET OUTLET
2100 601 02XX	TOPRAKSIZ PRİZ	SOCKET OUTLET NON- EARTHED
2100 605 02XX	TOPRAKLI PRİZ (ÇOCUK KORUMALI)	EARTHED SOCKET WITH CHILD PROTECTION
2100 606 02XX	TOPRAKSIZ PRİZ (ÇOCUK KORUMALI)	SOCKET OUTLET WITH CHILD PROTECTION NON EARTHED
2100 610 02XX	KAPAKLI TOPRAKLI PRİZ	EARTHED SOCKET WITH COVER
2100 611 02XX	KAPAKLI TOPRAKLI PRİZ (ÇOCUK KORUMALI)	EARTHED SOCKET WITH CHILD PROTECTION COVER
2100 615 02XX	UPS (FRANSIZ) PRİZİ	UPS (FRENCH) SOCKET (EARTHED SOCKET WITH PIN)
2100 616 02XX	UPS (FRANSIZ) PRİZİ (ÇOCUK KORUMALI)	UPS (FRENCH) SOCKET (CHILD PROTECTION)
2100 617 02XX	UPS KAPAKLI(FRANSIZ) PRİZİ	UPS SOCKET (FRENCH) WITH COVER
2100 618 02XX	UPS (FRANSIZ)KAP. TOPRAKLI PRİZ (ÇOC.KRM)	UPS SOCKET (FRENCH) WITH COVER (CHILD PROTECTION)
2100 200 02XX	İKİLİ TOPRAKLI PRİZ (PORSELEN)	DOUBLE SOCKET EARTHED PORCELAIN
2100 201 02XX	İKİLİ TOPRAKSIZ PRİZ (PORSELEN)	DOUBLE SOCKET (NON EARTHED) PORCELAIN
2100 202 02XX	İKİLİ TOPRAKLI PRİZ	DOUBLE SOCKET EARTHED
2100 203 02XX	İKİLİ TOPRAKSIZ PRİZ	DOUBLE SOCKET (NON EARTHED)
2100 215 01XX	İKİLİ UPS PRİZ	DOUBLE SOCKET WITH UPS (FRENCH)
2100 448 02XX	TEKLİ USB ŞARJ PRİZİ	USB CHARGE SOCKET
2100 449 02XX	İKİLİ USB ŞARJ PRİZİ	USB CHARGE TWO SOCKET
İLETİŞİM GRUBU		COMMUNICATIONS GROUP
2100 125 01XX	TELEFON PRİZİ 1* RJ12 (CAT 3)	TELEPHONE SOCKET 1* RJ12 (CAT 3)
2100 126 01XX	TELEFON PRİZİ 2* RJ12 (CAT 3)	TELEPHONE SOCKET 2* RJ12 (CAT 3)
2100 128 01XX	ETİKETLİ TELEFON DATA PRİZ (KON.SÜZ)	TELEPHONE DATA SOCKET WITH LABEL (WITHOUT CONNECTOR)
2100 135 02XX	DATA PRİZ 1* RJ45 (KONNEKTÖRSÜZ)	DATA SOCKET 1* RJ45 (WITHOUT CONNECTOR)
2100 136 01XX	DATA PRİZ 1* RJ45 (CAT 5E)	DATA SOCKET 1* RJ45 (CAT 5E)
2100 137 01XX	DATA PRİZ 2* RJ45 (KONNEKTÖRSÜZ)	DATA SOCKET 2* RJ45 (WITHOUT CONNECTOR)
2100 138 01XX	DATA PRİZ 2* RJ45 (CAT 5E)	DATA SOCKET 2* RJ45 (CAT 5E)
2100 139 01XX	DATA PRİZ (RJ12 CAT 3+CAT 5 E)	DATA SOCKET (RJ12 CAT 3+CAT 5 E)
2100 140 01XX	DATA PRİZ 1* RJ45 (CAT 6)	DATA SOCKET 1* RJ45 (CAT 6)
2100 141 01XX	DATA PRİZ 2* RJ45 (CAT 6)	DATA SOCKET 2* RJ45 (CAT 6)
2100 455 01XX	DATA PRİZ 1* USB	DATA SOCKET 1* USB
2100 456 01XX	DATA PRİZ 2* USB	DATA SOCKET 2* USB
2100 457 01XX	DATA PRİZ 1* HDMI	DATA SOCKET 1* HDMI
2100 458 01XX	DATA PRİZ 2* HDMI	DATA SOCKET 2* HDMI
2100 459 01XX	DATA PRİZ 1* USB / 1* HDMI	DATA SOCKET 1* USB / 1* HDMI
2100 460 01XX	VGA PRİZ	VGA SOCKET
2100 121 02XX	KÖR KAPAK	BLIND COVER
TV / SAT GRUBU		TV / SAT GROUP
2100 156 02XX	TV / SAT PRİZİ (GEÇİŞLİ) 4DB/F KON.	TV / SAT SOCKET (THROUGH) 4DB/F CON.
2100 157 02XX	TV / SAT PRİZİ (SONLU)	TV / SAT SOCKET (DEAD-END)
2100 166 01XX	SAT PRİZİ (GEÇİŞLİ) 4DB/F KON.	SAT SOCKET (THROUGH)
2100 167 01XX	SAT PRİZİ (SONLU)	SAT SOCKET (DEAD-END)
2100 170 01XX	TV PRİZİ (GEÇİŞLİ) 11 DB	TV SOCKET (THROUGH) 11 DB
2100 171 01XX	TV PRİZİ (SONLU)	TV SOCKET (DEAD-END)
2100 172 01XX	TV PRİZİ F DIŞI	TV SOCKET F FEMALE
SIVA ÜSTÜ KASA		SURFACE BOX
2100 000 11XX	SIVA ÜSTÜ KASA	SURFACE MOUNTED BOX

Nemliyer

SERİSİ
SERIES



Islak mekanlar için güvenliđi artırılmıř IP44 koruma sınıfında.
Naturel ve ahřap renk seęenekleriyle sıva üstü anahtar
uygulamalarının vazgeçilmez ürünleri.

Surface

SIVA ÜSTÜ • SURFACE

For wet places
security-enhanced IP44
protection class.
Indispensable products
for surface switch appli-
cations with natural and
wood color choices...



Nemliyer

TEKNİK BİLGİLER
TECHNICAL FEATURES

IP44

BOYUTLAR • DIMENSIONS

Tuşlu ürün ölçüleri • Plate product dimensions

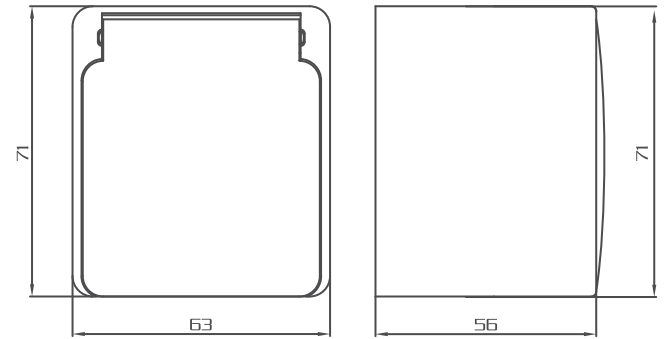
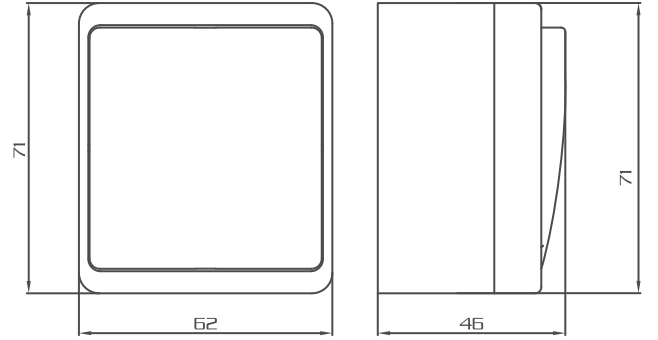

Soketli ürün ölçüleri • Socket product dimensions

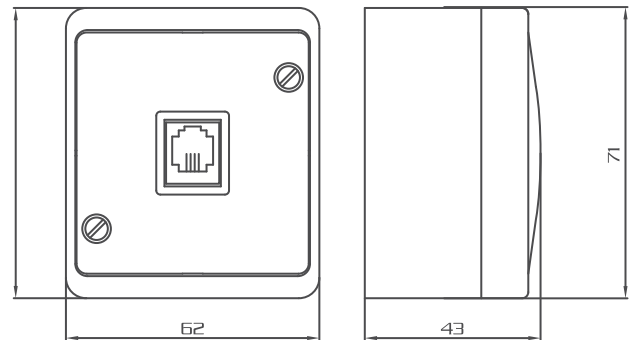

ÜRÜN LİSTESİ • PRODUCT LIST

Kod / Code	Ürün Tanımı	Description
2150 001 01XX	ANAHTAR	ONE GANG ONE WAY SWITCH
2150 002 01XX	KOMİTATÖR	TWO GANG ONE WAY SWITCH
2150 003 01XX	VAVİEN	ONE GANG TWO WAY SWITCH (VEAVIEN)
2150 005 01XX	ÇİFT KUTUPLU ANAHTAR	DOUBLE POLE SWITCH
2150 007 01XX	LİGHT (ÇAĞIRMA)	ONE GANG ONE WAY CONTROL SWITCH
2150 008 01XX	DEVİATÖR (ARA VAVİEN)	ONE GANG INTERMEDIATE SWITCH
2150 110 02XX	KAPAKLI TOPRAKLI PRİZ	EARTHED SOCKET WITH COVER
2150 115 02XX	KAPAKLI UPS (FRANSIZ) PRİZ	UPS (FRENCH) SOCKET WITH COVER
2150 125 02XX	TELEFON PRİZİ 1*RJ12 (Cat3)	TELEPHONE SOCKET 1*RJ12 (Cat3)
2150 136 01XX	DATA PRİZİ 1*RJ45 (Cat5e)	DATA SOCKET 1*RJ45 (Cat5e)
2150 166 02XX	SAT PRİZİ (GEÇİŞLİ)	SAT SOCKET (THROUGH)
2150 167 02XX	SAT PRİZİ (SONLU)	SAT SOCKET (DEAD-END)
2150 170 02XX	TV PRİZİ (GEÇİŞLİ)	TV SOCKET (THROUGH)
2150 171 02XX	TV PRİZİ (SONLU)	TV SOCKET (DEAD-END)

RENK SEÇENEKLERİ • COLOR OPTIONS



XX : 01 Beyaz • White

XX : 03 Gri • Grey



XX : 40 Açık Kayın • Light Beech

XX : 41 Koyu Ceviz • Dark Walnuts

XX : 43 Merbau

XX : 44 Maun • Mahogany

XX : 44 Armut • Pear

Bron
SERİSİ
SERIES



Sıva üstü uygulamalarda sorunsuz işlevsel çözümler...

Duvarlarda zarif dokunuşların izini sürün.
Hem şık hem işlevsel ürünlerin hazzını yaşayın.

Hassle-free functional solutions in surface switch applications...

Follow the elegant touches on the walls. Enjoy the pleasures of both stylish and functional products.



Bron

TEKNİK BİLGİLER
TECHNICAL FEATURES

BOYUTLAR • DIMENSIONS

Tuşlu ürün ölçüleri • Plate product dimensions

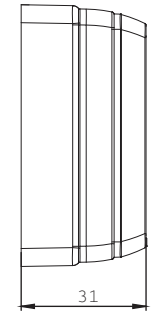
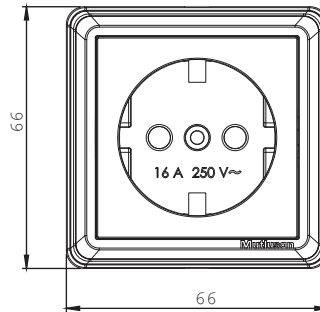
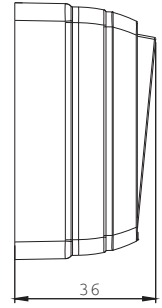
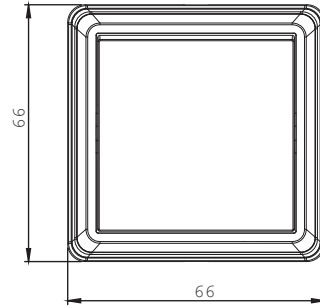

Soketli ürün ölçüleri • Socket product dimensions

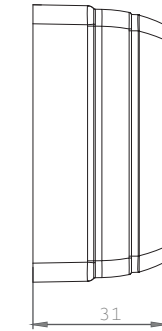
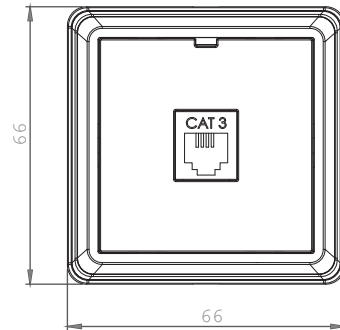

ÜRÜN LİSTESİ • PRODUCT LIST

Kod / Code	Ürün Tanımı	Description
2160 301 02XX	ANAHTAR	ONE GANG ONE WAY SWITCH
2160 302 02XX	KOMİTATÖR	TWO GANG ONE WAY SWITCH
2160 303 02XX	VAVİEN	ONE GANG TWO WAY SWITCH (VEAVIEN)
2160 307 02XX	LIGHT (ÇAĞIRMA)	ONE GANG ONE WAY CONTROL SWITCH
2160 315 02XX	İŞIKLI ANAHTAR (220V)	ILLUMINATED ONE GANG ONE WAY SWITCH (220V)
2160 316 02XX	İŞIKLI VAVİEN (220V)	ILLUMINATED ONE GANG TWO WAY SWITCH (220V) (VEAVIEN)
2160 317 02XX	İŞIKLI LIGHT (ÇAĞIRMA) (220V)	ILLUMINATED ONE GANG ONE WAY CONTROL SWITCH (220V)
2160 326 02XX	İŞIKLI KOMİTATÖR	ILLUMINATED TWO GANG ONE WAY SWITCH (220V)
2160 100 02XX	TOPRAKLI PRİZ	SOCKET OUTLET WITH EARTHED CONTACT (EARTHED SOCKET)
2160 101 02XX	TOPRAKSIZ PRİZ	SOCKET OUTLET
2160 103 02XX	TOPRAKLI PRİZ PORSELEN	SOCKET OUTLET WITH EARTHED CONTACT (EARTHED SOCKET) PORCELAIN
2160 104 02XX	TOPRAKSIZ PRİZ PORSELEN	SOCKET OUTLET PORCELAIN
2160 110 02XX	KAPAKLI TOPRAKLI PRİZ	EARTHED SOCKET WITH COVER
2160 113 02XX	KAPAKLI TOPRAKLI PRİZ PORSELEN	EARTHED SOCKET WITH COVER PORCELAIN
2160 115 02XX	UPS (FRANSIZ) PRİZ	UPS (FRENCH) SOCKET (EARTHED SOCKET WITH PIN)
2160 125 02XX	TELEFON PRİZİ 1*RJ12	TELEPHONE SOCKET 1*RJ12 (CAT3)
2160 136 02XX	DATA PRİZİ 1*RJ45 (CAT5)	DATA SOCKET 1*RJ45 (CAT5)
2160 166 02XX	SAT PRİZİ (GEÇİŞLİ) 4DB/F KONNEKTÖR	SAT SOCKET (THROUGH) 4DB/F CONNECTOR
2160 167 02XX	SAT PRİZİ (SONLU)	SAT SOCKET (DEAD-END)
2160 170 02XX	TV PRİZİ (GEÇİŞLİ)	TV SOCKET (THROUGH)
2160 171 02XX	TV PRİZİ (SONLU)	TV SOCKET (DEAD-END)
2160 200 02XX	İKİLİ TOP.LI PRİZ PORSELEN	TWO SOCKET OUTLET WITH EARTHED CONTACT (EARTHED SOCKET) PORCELAIN
2160 201 02XX	İKİLİ TOPRAKSIZ PRİZ PORSELEN	TWO SOCKET OUTLET PORCELAIN
2160 202 02XX	İKİLİ TOPRAKLI PRİZ	TWO SOCKET OUTLET WITH EARTHED CONTACT (EARTHED SOCKET)
2160 203 02XX	İKİLİ TOPRAKSIZ PRİZ	TWO SOCKET OUTLET
2160 215 02XX	İKİLİ UPS (FRANSIZ) PRİZ	UPS DOUBLE (FRENCH) OUTLET

RENK SEÇENEKLERİ • COLOR OPTIONS



XX : 01 Beyaz • White

XX : 02 Krem • Ivory

XX : 57 Ceviz • Walnuts

XX : 58 Meşe • Oak



Olimpia

Liva

Aksesuarlar • Accessories



GRUP PRİZLER
GROUP SOCKETS

Olimpiä

GRUP PRİZLER
GROUP SOCKETS



Anahtarlı, anahtarsız, UPS, kablolu, klemensli, ikili, üçlü, dördlü, altılı seçenekleriyle taşınabilir enerji ihtiyaçlarınızı karşılayacak.

Group Sockets

GRUP PRIZLER • GROUP SOCKETS

It will meet your portable energy needs with key / keyless switch, UPS, wired, terminal, two gang, three gang, four gang, six gang options.



Liva
GRUP PRİZLER
GROUP SOCKETS



Kendinden askılı kullanım kolaylığı...

Anahtarlı, anahtarsız, UPS, kablolu, klemensli, üçlü, dörtlü, altılı seçenekleriyle taşınabilir enerji ihtiyaçlarınızı karşılayacak.

Group Sockets

GRUP PRIZLER • GROUP SOCKETS

Ease of use with self-hanger...

It will meet your portable energy needs with key / keyless switch, UPS, wired, terminal, two gang, three gang, four gang, six gang options.



Ürün Listesi

Product List

Kod / Code	Ürün Tanımı	Description
001 171 210001 00 00	İKİLİ TOPRAKLI GRUP PRİZ(KLEMENSLİ)	2 GANG EARTHED SOCKET (WITH TERMINAL)
001 171 210002 02 00	İKİLİ TOPRAKLI GRUP PRİZ(2 MT)	2 GANG EARTHED SOCKET OUTLET (2 mt cord)
001 171 210002 03 00	İKİLİ TOPRAKLI GRUP PRİZ(3 MT)	2 GANG EARTHED SOCKET OUTLET (3 mt cord)
001 171 210002 05 00	İKİLİ TOPRAKLI GRUP PRİZ(5 MT)	2 GANG EARTHED SOCKET OUTLET (5 mt cord)
001 171 290001 00 00	İKİLİ TOPRAKSIZ GRUP PRİZ(KLEMENSLİ)	2 GANG GROUP SOCKET OUTLET CORDLESS
001 171 290002 02 00	İKİLİ TOPRAKSIZ GRUP PRİZ(2 MT)	2 GANG GROUP SOCKET (2 mt)
001 171 290002 03 00	İKİLİ TOPRAKSIZ GRUP PRİZ(3 MT)	2 GANG GROUP SOCKET (3 mt)
001 171 290002 05 00	İKİLİ TOPRAKSIZ GRUP PRİZ(5 MT)	2 GANG GROUP SOCKET (5 mt)
001 171 390001 00 00	ÜÇLÜ TOPRAKSIZ GRUP PRİZ(KLEMENSLİ)	3 GANG GROUP SOCKET (WITH TERMINAL)
001 171 390002 02 00	ÜÇLÜ TOPRAKSIZ GRUP PRİZ(2MT)	3 GANG SOCKET SOCKET OUTLET (2 mt cord)
001 171 390002 03 00	ÜÇLÜ TOPRAKSIZ GRUP PRİZ(3MT)	3 GANG SOCKET SOCKET OUTLET (3 mt cord)
001 171 390002 05 00	ÜÇLÜ TOPRAKSIZ GRUP PRİZ(5MT)	3 GANG SOCKET SOCKET OUTLET (5 mt cord)
001 171 310001 00 00	ÜÇLÜ TOPRAKLI GRUP PRİZ(KLEMENSLİ)	3 GANG EARTHED SOCKET (WITH TERMINAL)
001 171 310002 02 00	ÜÇLÜ TOPRAKLI GRUP PRİZ(2MT)	3 GANG EARTHED SOCKET (2 mt)
001 171 310002 03 00	ÜÇLÜ TOPRAKLI GRUP PRİZ(3MT)	3 GANG EARTHED SOCKET (3 mt)
001 171 310002 05 00	ÜÇLÜ TOPRAKLI GRUP PRİZ(5MT)	3 GANG EARTHED SOCKET (5 mt)
001 171 320001 00 00	ÜÇLÜ TOPRAKLI GRUP PRİZ(KLEMENSLİ-ANAHTARLI)	3 GANG EARTHED SOCKET (WITH TERMINAL AND SWITCH)
001 171 320002 02 00	ÜÇLÜ TOPRAKLI GRUP PRİZ(ANAHTARLI 2 MT)	3 GANG EARTHED SOCKET (WITH SWITCH 2 mt)
001 171 320002 03 00	ÜÇLÜ TOPRAKLI GRUP PRİZ(ANAHTARLI 3 MT)	3 GANG EARTHED SOCKET (WITH SWITCH 3 mt)
001 171 320002 05 00	ÜÇLÜ TOPRAKLI GRUP PRİZ(ANAHTARLI 5 MT)	3 GANG EARTHED SOCKET (WITH SWITCH 5 mt)
001 171 340001 00 00	ÜÇLÜ UPS GRUP PRİZ(KLEMENSLİ)	EARTHED 3 GANG UPS SOCKET (WITH TERMINAL)
001 171 330001 02 00	ÜÇLÜ UPS GRUP PRİZ(2MT)	3 GANG UPS EARTHED (2 mt)
001 171 330001 03 00	ÜÇLÜ UPS GRUP PRİZ(3MT)	3 GANG UPS EARTHED (3 mt)
001 171 330001 05 00	ÜÇLÜ UPS GRUP PRİZ(5MT)	3 GANG UPS EARTHED (5 mt)
001 171 410001 00 00	DÖRTLÜ TOPRAKLI GRUP PRİZ(KLEMENSLİ)	4 GANG EARTHED SOCKET (WITH TERMINAL)
001 171 410001 02 00	DÖRTLÜ TOPRAKLI GRUP PRİZ(2MT)	4 GANG EARTHED SOCKET (2 mt)
001 171 410001 03 00	DÖRTLÜ TOPRAKLI GRUP PRİZ(3MT)	4 GANG EARTHED SOCKET (3 mt)
001 171 410001 05 00	DÖRTLÜ TOPRAKLI GRUP PRİZ(5MT)	4 GANG EARTHED SOCKET (5 mt)
001 171 410002 00 00	DÖRTLÜ TOPRAKLI GRUP PRİZ(KLEMENSLİ-ANAHTARLI)	4 GANG EARTHED SOCKET (WITH TERMINAL AND SWITCH)
001 171 410002 02 00	DÖRTLÜ TOPRAKLI GRUP PRİZ(ANAHTARLI 2 MT)	4 GANG EARTHED SOCKET(WITH SWITCH 2 mt)
001 171 410002 03 00	DÖRTLÜ TOPRAKLI GRUP PRİZ(ANAHTARLI 3 MT)	4 GANG EARTHED SOCKET(WITH SWITCH 3 mt)
001 171 410002 05 00	DÖRTLÜ TOPRAKLI GRUP PRİZ(ANAHTARLI 5 MT)	4 GANG EARTHED SOCKET(WITH SWITCH 5 mt)
001 171 610001 00 00	ALTILI TOPRAKLI GRUP PRİZ(KLEMENSLİ)	6 GANG EARTHED SOCKET (WITH TERMINAL)
001 171 610001 02 00	ALTILI TOPRAKLI GRUP PRİZ(2 MT)	6 GANG EARTHED SOCKET (2 mt)
001 171 610001 03 00	ALTILI TOPRAKLI GRUP PRİZ(3 MT)	6 GANG EARTHED SOCKET (3 mt)
001 171 610001 05 00	ALTILI TOPRAKLI GRUP PRİZ(5 MT)	6 GANG EARTHED SOCKET (5 mt)
001 171 610002 00 00	ALTILI TOPRAKLI GRUP PRİZ(KLEMENSLİ-ANAHTARLI)	6 GANG EARTHED SOCKET (WITH TERMINAL AND SWITCH)
001 171 610002 02 00	ALTILI TOPRAKLI GRUP PRİZ(ANAHTARLI 2 MT)	6 GANG EARTHED SOCKET(WITH SWITCH 2 mt)
001 171 610002 03 00	ALTILI TOPRAKLI GRUP PRİZ(ANAHTARLI 3 MT)	6 GANG EARTHED SOCKET(WITH SWITCH 3 mt)
001 171 610002 05 00	ALTILI TOPRAKLI GRUP PRİZ(ANAHTARLI 5 MT)	6 GANG EARTHED SOCKET(WITH SWITCH 5 mt)

Ürün Listesi

Product List

Kod / Code	Ürün Tanımı	Description
001 170 310001 00 00	ÜÇLÜ TOPRAKLI GRUP PRIZ (KLEMENSLİ) (ÇOCUK KORUMALI)	EARTHED 3 GANG SOCKET OUTLET CORDLESS (WITH CHILD PROTECTION)
001 170 310001 02 00	ÜÇLÜ TOPRAKLI GRUP PRIZ (2MT) (ÇOCUK KORUMALI)	EARTHED 3 GANG SOCKET OUTLET (2 mt CORD) (WITH CHILD PROTECTION)
001 170 310001 03 00	ÜÇLÜ TOPRAKLI GRUP PRIZ (3MT) (ÇOCUK KORUMALI)	EARTHED 3 GANG SOCKET OUTLET (3 mt CORD) (WITH CHILD PROTECTION)
001 170 310001 05 00	ÜÇLÜ TOPRAKLI GRUP PRIZ (5MT) (ÇOCUK KORUMALI)	EARTHED 3 GANG SOCKET OUTLET (5 mt CORD) (WITH CHILD PROTECTION)
001 170 320001 00 00	ÜÇLÜ TOPRAKLI GRUP PRIZ (ANAHTARLI) (ÇOCUK KORUMALI)	EARTHED 3 GANG SOCKET OUTLET CORDLESS + W.S. (WITH CHILD PROTECTION)
001 170 310002 02 00	ÜÇLÜ TOPRAKLI GRUP PRIZ (ANAHTARLI 2 MT) (ÇOCUK KORUMALI)	EARTHED 3 GANG SOCKET OUTLET W.S. + 2 Mt c. (WITH CHILD PROTECTION)
001 170 310002 03 00	ÜÇLÜ TOPRAKLI GRUP PRIZ (ANAHTARLI 3 MT) (ÇOCUK KORUMALI)	EARTHED 3 GANG SOCKET OUTLET W.S. + 3 Mt c. (WITH CHILD PROTECTION)
001 170 310002 05 00	ÜÇLÜ TOPRAKLI GRUP PRIZ (ANAHTARLI 5 MT) (ÇOCUK KORUMALI)	EARTHED 3 GANG SOCKET OUTLET W.S. + 5 Mt c. (WITH CHILD PROTECTION)
001 170 340001 00 00	ÜÇLÜ UPS GRUP PRIZ (KLEMENSLİ) (ÇOCUK KORUMALI)	EARTHED 3 GANG UPS (FRENCH) SOCKET OUTLET CORDLESS WITH SWITCH (WITH CHILD PROTECTION)
001 170 330001 02 00	ÜÇLÜ UPS GRUP PRIZ (2MT) (ÇOCUK KORUMALI)	3 GANG UPS (FRENCH) EARTHED (2 mt) (WITH CHILD PROTECTION)
001 170 330001 03 00	ÜÇLÜ UPS GRUP PRIZ (3MT) (ÇOCUK KORUMALI)	3 GANG UPS (FRENCH) EARTHED (3 mt) (WITH CHILD PROTECTION)
001 170 330001 05 00	ÜÇLÜ UPS GRUP PRIZ (5MT) (ÇOCUK KORUMALI)	3 GANG UPS (FRENCH) EARTHED (5 mt) (WITH CHILD PROTECTION)
001 170 350001 00 00	ÜÇLÜ UPS GRUP PRIZ (KLEMENSLİ-ANAHTARLI) (ÇOCUK KORUMALI)	EARTHED 3 GANG UPS (FRENCH) SOCKET OUTLET CORDLESS (WITH CHILD PROTECTION)
001 170 360001 02 00	ÜÇLÜ UPS GRUP PRIZ (ANAHTARLI 2 MT) (ÇOCUK KORUMALI)	3 GANG UPS (FRENCH) EARTHED (WHIT SWITCH 2 mt) (WITH CHILD PROTECTION)
001 170 360001 03 00	ÜÇLÜ UPS GRUP PRIZ (ANAHTARLI 3 MT) (ÇOCUK KORUMALI)	3 GANG UPS (FRENCH) EARTHED (WHIT SWITCH 3 mt) (WITH CHILD PROTECTION)
001 170 360001 05 00	ÜÇLÜ UPS GRUP PRIZ (ANAHTARLI 5 MT) (ÇOCUK KORUMALI)	3 GANG UPS (FRENCH) EARTHED (WHIT SWITCH 5 mt) (WITH CHILD PROTECTION)
001 170 410001 00 00	DÖRTLÜ TOPRAKLI GRUP PRIZ (KLEMENSLİ) (ÇOCUK KORUMALI)	EARTHED 4 GANG SOCKET OUTLET CORDLESS (WITH CHILD PROTECTION)
001 170 410001 02 00	DÖRTLÜ TOPRAKLI GRUP PRIZ (2MT) (ÇOCUK KORUMALI)	EARTHED 4 GANG SOCKET OUTLET (2 mt CORD) (WITH CHILD PROTECTION)
001 170 410001 03 00	DÖRTLÜ TOPRAKLI GRUP PRIZ (3MT) (ÇOCUK KORUMALI)	EARTHED 4 GANG SOCKET OUTLET (3 mt CORD) (WITH CHILD PROTECTION)
001 170 410001 05 00	DÖRTLÜ TOPRAKLI GRUP PRIZ (5MT) (ÇOCUK KORUMALI)	EARTHED 4 GANG SOCKET OUTLET (5 mt CORD) (WITH CHILD PROTECTION)
001 170 420001 00 00	DÖRTLÜ TOPRAKLI GRUP PRIZ (ANAHTARLI) (ÇOCUK KORUMALI)	EARTHED 4 GANG SOCKET OUTLET CORDLESS + W.S. (WITH CHILD PROTECTION)
001 170 410002 02 00	DÖRTLÜ TOPRAKLI GRUP PRIZ (ANAHTARLI 2 MT) (ÇOCUK KORUMALI)	EARTHED 4 GANG SOCKET OUTLET W.S. + 2 Mt c. (WITH CHILD PROTECTION)
001 170 410002 03 00	DÖRTLÜ TOPRAKLI GRUP PRIZ (ANAHTARLI 3 MT) (ÇOCUK KORUMALI)	EARTHED 4 GANG SOCKET OUTLET W.S. + 3 Mt c. (WITH CHILD PROTECTION)
001 170 410002 05 00	DÖRTLÜ TOPRAKLI GRUP PRIZ (ANAHTARLI 5 MT) (ÇOCUK KORUMALI)	EARTHED 4 GANG SOCKET OUTLET W.S. + 5 Mt c. (WITH CHILD PROTECTION)
001 170 440001 00 00	DÖRTLÜ UPS GRUP PRIZ (KLEMENSLİ) (ÇOCUK KORUMALI)	EARTHED 4 GANG UPS (FRENCH) SOCKET OUTLET CORDLESS WITH SWITCH (WITH CHILD PROTECTION)
001 170 430001 02 00	DÖRTLÜ UPS GRUP PRIZ (2MT) (ÇOCUK KORUMALI)	4 GANG UPS (FRENCH) EARTHED (2 mt) (WITH CHILD PROTECTION)
001 170 430001 03 00	DÖRTLÜ UPS GRUP PRIZ (3MT) (ÇOCUK KORUMALI)	4 GANG UPS (FRENCH) EARTHED (3 mt) (WITH CHILD PROTECTION)
001 170 430001 05 00	DÖRTLÜ UPS GRUP PRIZ (5MT) (ÇOCUK KORUMALI)	4 GANG UPS (FRENCH) EARTHED (5 mt) (WITH CHILD PROTECTION)
001 170 450001 00 00	DÖRTLÜ UPS GRUP PRIZ (KLEMENSLİ-ANAHTARLI) (ÇOCUK KORUMALI)	EARTHED 4 GANG UPS (FRENCH) SOCKET OUTLET CORDLESS (WITH CHILD PROTECTION)
001 170 460001 02 00	DÖRTLÜ UPS GRUP PRIZ (ANAHTARLI 2 MT) (ÇOCUK KORUMALI)	4 GANG UPS (FRENCH) EARTHED (WHIT SWITCH 2 mt) (WITH CHILD PROTECTION)
001 170 460001 03 00	DÖRTLÜ UPS GRUP PRIZ (ANAHTARLI 3 MT) (ÇOCUK KORUMALI)	4 GANG UPS (FRENCH) EARTHED (WHIT SWITCH 3 mt) (WITH CHILD PROTECTION)
001 170 460001 05 00	DÖRTLÜ UPS GRUP PRIZ (ANAHTARLI 5 MT) (ÇOCUK KORUMALI)	4 GANG UPS (FRENCH) EARTHED (WHIT SWITCH 5 mt) (WITH CHILD PROTECTION)
001 170 610001 00 00	ALTILI TOPRAKLI GRUP PRIZ (KLEMENSLİ) (ÇOCUK KORUMALI)	EARTHED 6 GANG SOCKET OUTLET CORDLESS (WITH CHILD PROTECTION)
001 170 610001 02 00	ALTILI TOPRAKLI GRUP PRIZ (2MT) (ÇOCUK KORUMALI)	EARTHED 6 GANG SOCKET OUTLET (2 mt CORD) (WITH CHILD PROTECTION)
001 170 610001 03 00	ALTILI TOPRAKLI GRUP PRIZ (3MT) (ÇOCUK KORUMALI)	EARTHED 6 GANG SOCKET OUTLET (3 mt CORD) (WITH CHILD PROTECTION)
001 170 610001 05 00	ALTILI TOPRAKLI GRUP PRIZ (5MT) (ÇOCUK KORUMALI)	EARTHED 6 GANG SOCKET OUTLET (5 mt CORD) (WITH CHILD PROTECTION)
001 170 620001 00 00	ALTILI TOPRAKLI GRUP PRIZ (ANAHTARLI) (ÇOCUK KORUMALI)	EARTHED 6 GANG SOCKET OUTLET CORDLESS + W.S. (WITH CHILD PROTECTION)
001 170 620002 02 00	ALTILI TOPRAKLI GRUP PRIZ (ANAHTARLI 2 MT) (ÇOCUK KORUMALI)	EARTHED 6 GANG SOCKET OUTLET W.S. + 2 Mt c. (WITH CHILD PROTECTION)
001 170 620003 03 00	ALTILI TOPRAKLI GRUP PRIZ (ANAHTARLI 3 MT) (ÇOCUK KORUMALI)	EARTHED 6 GANG SOCKET OUTLET W.S. + 3 Mt c. (WITH CHILD PROTECTION)
001 170 620004 05 00	ALTILI TOPRAKLI GRUP PRIZ (ANAHTARLI 5 MT) (ÇOCUK KORUMALI)	EARTHED 6 GANG SOCKET OUTLET W.S. + 5 Mt c. (WITH CHILD PROTECTION)
001 170 640001 00 00	ALTILI UPS GRUP PRIZ (KLEMENSLİ) (ÇOCUK KORUMALI)	EARTHED 6 GANG UPS (FRENCH) SOCKET OUTLET CORDLESS WITH SWITCH (WITH CHILD PROTECTION)
001 170 630001 02 00	ALTILI UPS GRUP PRIZ (2MT) (ÇOCUK KORUMALI)	6 GANG UPS (FRENCH) EARTHED (2 mt) (WITH CHILD PROTECTION)
001 170 630001 03 00	ALTILI UPS GRUP PRIZ (3MT) (ÇOCUK KORUMALI)	6 GANG UPS (FRENCH) EARTHED (3 mt) (WITH CHILD PROTECTION)
001 170 630001 05 00	ALTILI UPS GRUP PRIZ (5MT) (ÇOCUK KORUMALI)	6 GANG UPS (FRENCH) EARTHED (5 mt) (WITH CHILD PROTECTION)
001 170 650001 00 00	ALTILI UPS GRUP PRIZ (KLEMENSLİ-ANAHTARLI) (ÇOCUK KORUMALI)	EARTHED 6 GANG UPS (FRENCH) SOCKET OUTLET CORDLESS (WITH CHILD PROTECTION)
001 170 660001 02 00	ALTILI UPS GRUP PRIZ (ANAHTARLI 2 MT) (ÇOCUK KORUMALI)	6 GANG UPS (FRENCH) EARTHED (WHIT SWITCH 2 mt) (WITH CHILD PROTECTION)
001 170 660001 03 00	ALTILI UPS GRUP PRIZ (ANAHTARLI 3 MT) (ÇOCUK KORUMALI)	6 GANG UPS (FRENCH) EARTHED (WHIT SWITCH 3 mt) (WITH CHILD PROTECTION)
001 170 660001 05 00	ALTILI UPS GRUP PRIZ (ANAHTARLI 5 MT) (ÇOCUK KORUMALI)	6 GANG UPS (FRENCH) EARTHED (WHIT SWITCH 5 mt) (WITH CHILD PROTECTION)

Aksesuarlar

ACCESSORIES



AKSESUARLAR • ACCESSORIES



ÜRÜN LİSTESİ • PRODUCT LIST

Kod • Code	Ürün Tanımı	Description
001 170 011001 00 00	TOPRAKLI ERKEK FİŞ	EARTHED MALE PLUG
001 170 011002 00 00	KULPLU TOPRAKLI ERKEK FİŞ	EARTHED MALE PLUG WITH HANDLE
001 170 011003 00 00	TOPRAKLI ERKEK FİŞ UPS (KUYRUKLU)	EARTHED MALE PLUG USB (TAILED)
001 170 012001 00 00	TOPRAKLI ERKEK FİŞ (KUYRUKLU)	EARTHED MALE PLUG (TAILED)
001 170 021001 00 00	TOPRAKLI DIŞI FİŞ	EARTHED FEMALE PLUG
001 170 010001 00 00	ERKEK FİŞ	MALE SOCKET
001 170 020001 00 00	DIŞI FİŞ	FEMALE SOCKET
001 170 033001 00 00	TOPRAKLI ÜÇLÜ FİŞ-PRİZ (YONCA TİP) (SIVAALTI)	TRIPLE EARTHED SOCKET - SWITCH (YONCA TYPE) (RECESSED MOUNTED)
001 170 033002 00 00	TOPRAKLI ÜÇLÜ FİŞ-PRİZ (YONCA TİP) (SIVAÜSTÜ)	TRIPLE EARTHED SOCKET - SWITCH (YONCA TYPE) (SURFACE MOUNTED)
001 170 030002 00 00	ADAPTÖR FİŞ - PRİZ (İNGİLİZ TİP)	ADAPTER - SOCKET (BRITISH TYPE)
001 170 030001 00 00	ARAPUAR ANAHTAR	BAKALITE HAND SWITCH
001 170 033003 00 00	İKİLİ TOPRAKLI FİŞ - PRİZ (DÜZ TİP)	EARTHED 2 GANG SOCKET
001 170 033005 00 00	ÜÇLÜ TOPRAKLI FİŞ - PRİZ (DÜZ TİP)	EARTHED 3 GANG SOCKET
001 170 033004 00 00	ÜÇLÜ TOPRAKLI FİŞ - PRİZ (DÜZ TİP ANAHTARLI)	EARTHED 3 GANG SOCKET (WITH SWITCH)

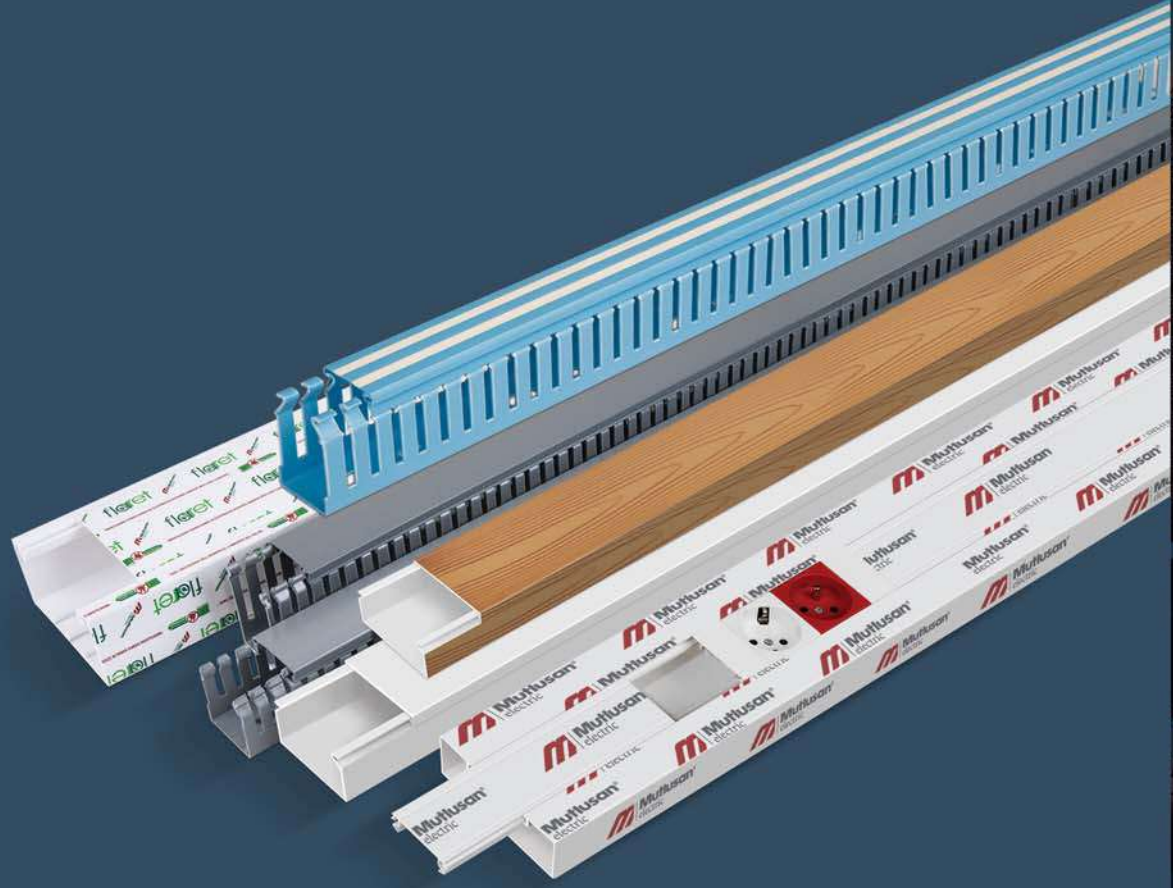

Kablo Kanalları • Cable Trunking

Renkli Kablo Kanalları • Colored Cable Trunking

Zemin Kablo Kanalları • Floor Cable Trunking

Delikli Kablo Kanalları • Slotted Cable Trunking



KABLO KANALLARI
CABLE TRUNKING

Neden Mutlusan kablo kanallarını kullanmalıyız?

Why we use should Mutlusan cable trunking?



1

Ürünlerimiz hafif ve dayanıklıdır,
Our products are light-weighted and durable,

2

Ürünlerimizin büyük çoğunluğunun aynı ebatlarda aksesuarları mevcuttur
Availability of cable trunking accessories with identical sizes for majority of our products,

3

İstenilen ölçülerde kesilebilir ve istenen renkte boyanabilir olma özelliği,
Our products can be tailor-cut to the desired dimensions and can be painted to desired color,

4

Zengin renk ve desenleriyle yapılarınızın dekorasyonu estetik bir uyum içerisinde oluşu,
Our products are in aesthetic harmony with the decoration of your buildings by virtue of rich color and pattern options,

5

Tadilatlı uygulamalar duvarda sıva hatalarına neden olurken, kablo kanalları uygulaması duvarlarınızın kırılıp dökülerek deforme olmasını önler,
While modification practices cause plaster errors on your walls, cable trunking applications prevent deformation of your walls due to demolition,

6

Kanal içindeki ray sistemiyle kabloların birbirinden bağımsız bir şekilde taşınabilmesi, aynı kanaldan birden fazla kablo geçirilebilir olması özelliği,
The rail system within the trunking enables installation of cables independently and multiple cables can be laid inside the same trunking,

7

Kablo kanallarındaki geçmeli sistemin montaj kolaylığı sağlar,
Ease of assembly through click-fit system at cable trunking,

8

Mükemmel kalıp tasarımı sayesinde üstün yüzey düzgünlüğü,
Superior surface smoothness by virtue of excellent die design,

9

Pano içi delikli kablo kanallarının endüstriyel uygulamalardaki esnek kablo döşemelerinde kullanılabilir
Perforated cable trunking can be used at flexible cable installations for industrial practices,

10

Priz ve anahtar montajında geçmeli montaj özelliği sayesinde pratik ve kolay sabitleme özelliği, kolay montaj,
Practical and easy fixation and easy assembly by virtue of click-fit assembly feature of power outlets and switches

11

Kanal gövdesindeki delikler sayesinde hızlı montaj olanağı, sabitleme ayakları sayesinde kolay anahtar ve priz montajı yapılabilir
Quick assembly by virtue of pre-drilled perforations on the trunking body and easy switch and socket assembly by virtue of fixing tool,

12

Elektrik kablolarının ve bilgisayar sistemlerinin düzenlenmesinde, asansör ve doğalgaz boru kapatmalarında, prefabrik yapılar ve güvenlik sistemlerinde yaygın kullanım.
Extensive usage for arrangement of electrical wiring and computer systems, elevator and natural gas piping enclosures and prefabricated structures and security systems

Teknik özellikler Technical specifications



Ultraviyole ışınlarına karşı dayanıklıdır.
Resistance to UV light.



Asit buharına dayanıklıdır.
Resistance to acidic vapor.



Darbelere dayanıklıdır.
Shock resistance.



Elektiriksel yalıtım özelliğine sahiptir.
Electrically insulated



Tüm kanallarımız çift taraflı yapışkanlı bant ile kullanılabilir.
Adhesive models are easy to install.



İstenilen renkte boyanabilir.
Can be painted to desired color.



Aşırı soğuğa ve sicağa karşı dayanıklı.
Resistant to extreme cold and heat.

IP4X

Katı yabancı maddelerin girişine karşı koruma.
Protection against ingress of solid foreign substances.

**Halogen Free
kablo kanalı**
Halogen free
cable trunking



flaret



Flame Retardant
Alev Yayımayan



25x16

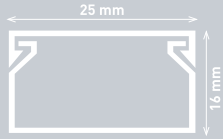

Ürün Kodu	Product Code	001 060 025016 20 00
Ambalaj Şekli	Packing Type	Kutu - Box
Adet / m	Quantity / m	150 m
Ağırlık	Weight	17.325 kg
m ³ /	Volume	0.07636

AKSESUARLAR - ACCESSORIES

Kod Code	Ürün Product	Adet Quantity	Ağırlık Weight	m ³ Volume
 001 039 025016 11 00	İç Köşe Internal Corner	40	0.323 kg	0.00292
 001 040 025016 11 00	Dış Köşe External Corner	40	0.432 kg	0.00260
 001 041 025016 11 00	T Köşe T Corner	30	0.324 kg	0.00260
 001 042 025016 11 00	90° L Köşe 90° L Corner	50	0.434 kg	0.00260
 001 043 025016 11 00	Ek Parça Connector	100	0.212 kg	0.00260
 001 044 025016 11 00	Uç Tapa Blind Cap	100	0.182 kg	0.00260
 001 047 025016 11 00	PM Kasası 1'li Socket Assembly Frame Single	12	1.161 kg	0.00731

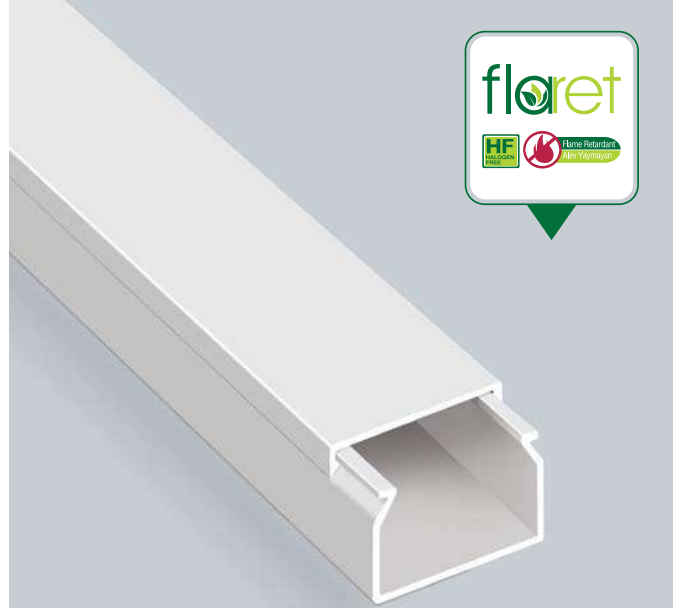

25x25

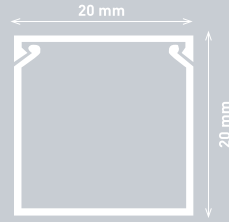

Ürün Kodu	Product Code	001 060 025025 20 00
Ambalaj Şekli	Packing Type	Kutu - Box
Adet / m	Quantity / m	100 m
Ağırlık	Weight	20 kg
m ³ /	Volume	0.07636

AKSESUARLAR - ACCESSORIES

Kod Code	Ürün Product	Adet Quantity	Ağırlık Weight	m ³ Volume
 001 039 025025 11 00	İç Köşe Internal Corner	40	0.343 kg	0.00292
 001 040 025025 11 00	Dış Köşe External Corner	40	0.448 kg	0.00260
 001 041 025025 11 00	T Köşe T Corner	30	0.327 kg	0.00260
 001 042 025025 11 00	90° L Köşe 90° L Corner	50	0.448 kg	0.00260
 001 043 025025 11 00	Ek Parça Connector	100	0.126 kg	0.00260
 001 044 025025 11 00	Uç Tapa Blind Cap	100	0.263 kg	0.00260
 001 047 025025 11 00	PM Kasası 1'li Socket Assembly Frame Single	12	1.161 kg	0.00731



40x25



Ürün Kodu	Product Code	001 060 04025 20 00
Ambalaj Şekli	Packing Type	Kutu - Box
Adet / m	Quantity / m	20 m
Ağırlık	Weight	17.700 kg
m ³ /	Volume	0.12022

AKSESUARLAR - ACCESSORIES

Kod Code	Ürün Product	Adet Quantity	Ağırlık Weight	m ³ Volume
 001 039 040025 11 00	İç Köşe Internal Corner	24	0.354 kg	0.01044
 001 040 040025 11 00	Dış Köşe External Corner	30	0.691 kg	0.00272
 001 041 040025 11 00	T Köşe T Corner	18	0.345 kg	0.00731
 001 042 040025 11 00	90° L Köşe 90° L Corner	24	0.376 kg	0.00272
 001 043 040025 11 00	Ek Parça Connector	70	0.283 kg	0.00728
 001 044 040025 11 00	Uç Tapa Blind Cap	25	0.152 kg	0.00128





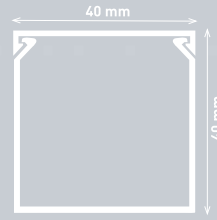



40x40



Ürün Kodu	Product Code	001 060 040040 20 00
Ambalaj Şekli	Packing Type	Kutu - Box
Adet / m	Quantity / m	50 m
Ağırlık	Weight	13.900 kg
m ³ /	Volume	0.0850

AKSESUARLAR - ACCESSORIES

Kod Code	Ürün Product	Adet Quantity	Ağırlık Weight	m ³ Volume
 001 039 040040 11 00	İç Köşe Internal Corner	18	0.441 kg	0.010458
 001 040 040040 11 00	Dış Köşe External Corner	10	0.290 kg	0.00272
 001 041 040040 11 00	T Köşe T Corner	48	1.265 kg	0.0073
 001 042 040040 11 00	90° L Köşe 90° L Corner	60	1.260 kg	0.0073
 001 043 040040 11 00	Ek Parça Connector	100	0.434 kg	0.0073
 001 044 040040 11 00	Uç Tapa Blind Cap	25	0.146 kg	0.0073



floret

HF
Flame Retardant
Alev Yalıtımlı

40x60

Aksesuarsız
Without Accessories

Ürün Kodu	Product Code	001 060 040060 20 00
Ambalaj Şekli	Packing Type	Kutu - Box
Adet / m	Quantity / m	30 m
Ağırlık	Weight	15.138 kg
m ³ /	Volume	0.07491

40 mm

60 mm



floret

HF
Flame Retardant
Alev Yalıtımlı

100x50

100 mm

50 mm

Ürün Kodu	Product Code	001 060 100050 20 00
Ambalaj Şekli	Packing Type	Kutu - Box
Adet / m	Quantity / m	20 m
Ağırlık	Weight	17.700 kg
m ³ /	Volume	0.12022

AKSESUARLAR - ACCESSORIES

	Kod Code	Ürün Product	Adet Quantity	Ağırlık Weight	m ³ Volume
	001 061 100050 20 00	Ara Bölme Partition	150 m	20,400 kg	0,054
	001 039 100050 11 00	İç Köşe Hareketli Internal Corner Live	12	0,583 kg	0,01045
	001 040 100050 11 00	Dış Köşe Hareketli External Corner Live	8	0,182 kg	0,01045
	001 041 100050 11 00	T Köşe T Corner	8	0,691 kg	0,01045
	001 042 100050 11 00	90° L Köşe 90° L Corner	8	0,764 kg	0,01045
	001 043 100050 11 00	Ek Parça Connector	12	1,056 kg	0,01045
	001 44 100050 11 00	Uç Tapa Blind Cap	12	1,006 kg	0,01045

Kendinden kapaklı kanallar
Cable trunking with internal cover

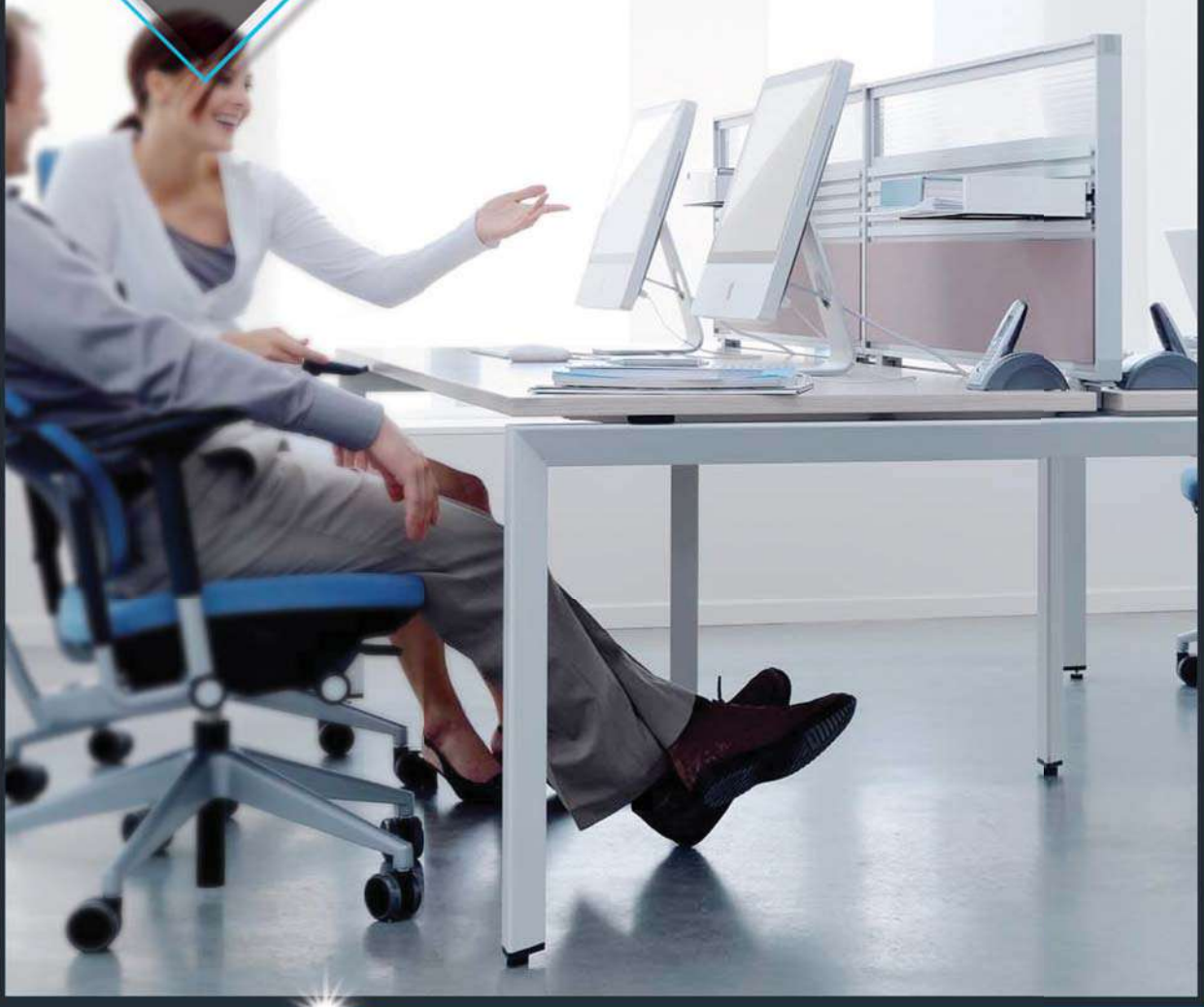

Kendinden Yapışkanlı
Self-Adhesive



Kendinden Kapaklı
Intrinsic Cover

**9x5****Aksesuarsız**
Without Accessories

Ürün Kodu	Product Code	001 004 009005 20 00
Ambalaj Şekli	Packing Type	Kutu - Box
Adet / m	Quantity / m	500 m
Ağırlık	Weight	18.4 kg
m ³ /	Volume	0.0435

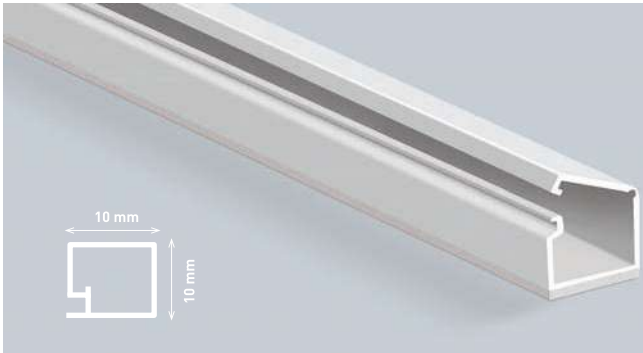
**10x10****Aksesuarsız**
Without Accessories

Ürün Kodu	Product Code	001 004 010010 20 00
Ambalaj Şekli	Packing Type	Kutu - Box
Adet / m	Quantity / m	330 m
Ağırlık	Weight	12.36 kg
m ³ /	Volume	0.0400

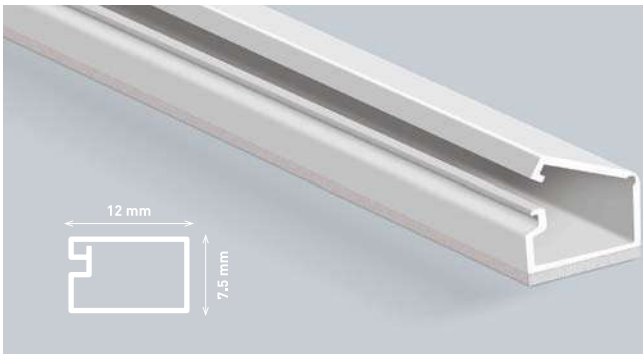
**12x7.5****Aksesuarsız**
Without Accessories

Ürün Kodu	Product Code	001 004 012007 20 00
Ambalaj Şekli	Packing Type	Kutu - Box
Adet / m	Quantity / m	350 m
Ağırlık	Weight	18.34 kg
m ³ /	Volume	0.0511

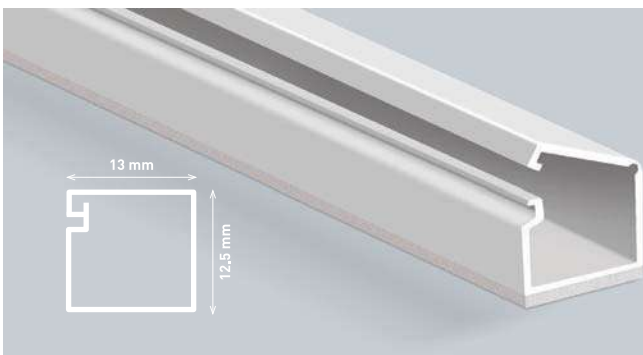
**13x12.5****Aksesuarsız**
Without Accessories

Ürün Kodu	Product Code	001 004 013012 20 00
Ambalaj Şekli	Packing Type	Kutu - Box
Adet / m	Quantity / m	300 m
Ağırlık	Weight	23.49 kg
m ³ /	Volume	0.0768

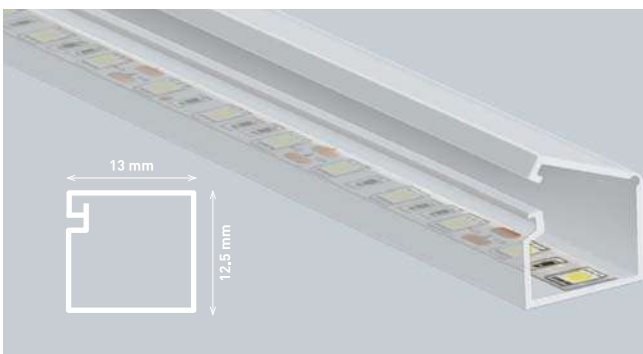
LED
için özel**13x12.5****Şeffaf Kanal**
Transparent Cable Trunking

Ürün Kodu	Product Code	001 004 013012 20 44
Ambalaj Şekli	Packing Type	Kutu - Box
Adet / m	Quantity / m	300 m
Ağırlık	Weight	23.49 kg
m ³ /	Volume	0.0768

**Dıştan kapaklı
kanallar**
Cable trunking with
external cover

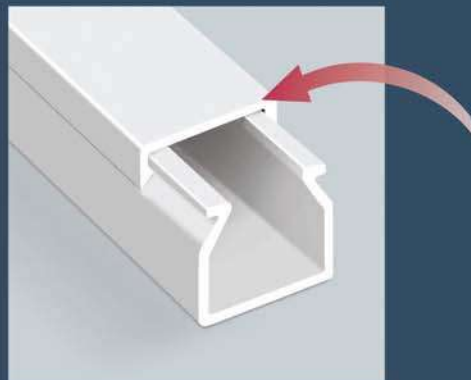
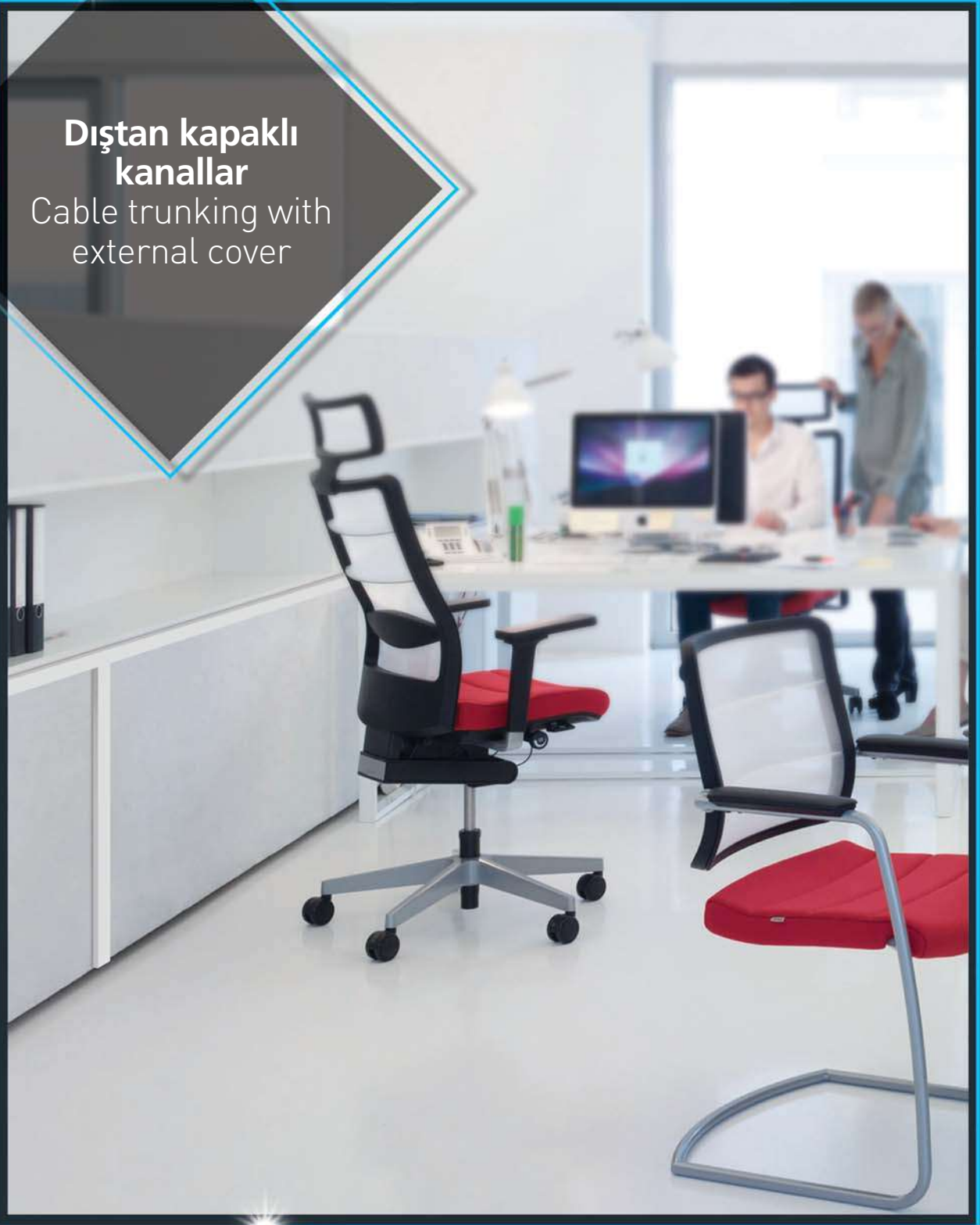

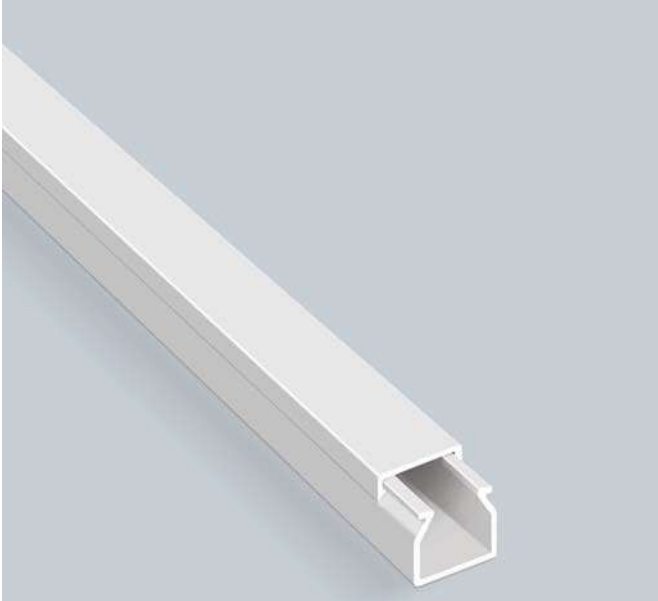
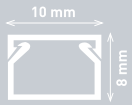

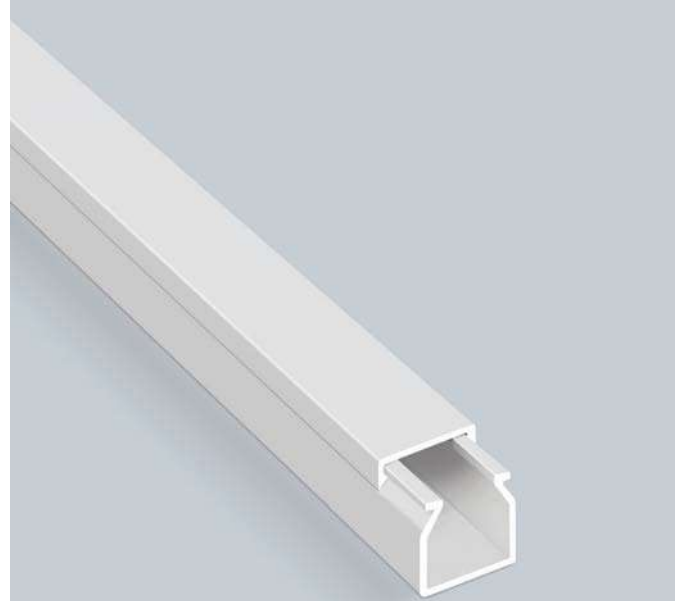
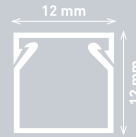

**10x8****Aksesuarsız**
Without Accessories

		EKO Serisi Series	MEKS Serisi Series
Ürün Kodu	Product Code	001 014 010008 20 00	001 002 010008 20 00
Ambalaj Şekli	Packing Type	Kutu - Box	Kutu - Box
Adet / m	Quantity / m	330 m	330 m
Ağırlık	Weight	15.85 kg	15.85 kg
m ³ /	Volume	0.04257	0.04257

**12x12**

		EKO Serisi Series	MEKS Serisi Series	CANALEX Serisi Series
Ürün Kodu	Product Code	001 014 012012 20 00	001 002 012012 20 00	001 156 012012 20 00
Ambalaj Şekli	Packing Type	Kutu - Box	Kutu - Box	Kutu - Box
Adet / m	Quantity / m	250 m	250 m	250 m
Ağırlık	Weight	17.8 kg	17.8 kg	17.8 kg
m ³ /	Volume	0.053	0.053	0.053

**AKSESUARLAR - ACCESSORIES**

	Kod Code	Ürün Product	Adet Quantity	Ağırlık Weight	m ³ Volume
	001 039 012012 00 00	İç Köşe Internal Corner	60	0.127 kg	0.00126
	001 040 012012 00 00	Dış Köşe External Corner	60	0.170 kg	0.00126
	001 041 012012 00 00	T Köşe T Corner	60	0.145 kg	0.00126
	001 042 012012 00 00	90° L Köşe 90° L Corner	60	0.170 kg	0.00126
	001 043 012012 00 00	Ek Parça Connector	100	0.141 kg	0.00120
	001 044 012012 00 00	Uç Tapa Blind Cap	100	0.131 kg	0.0012

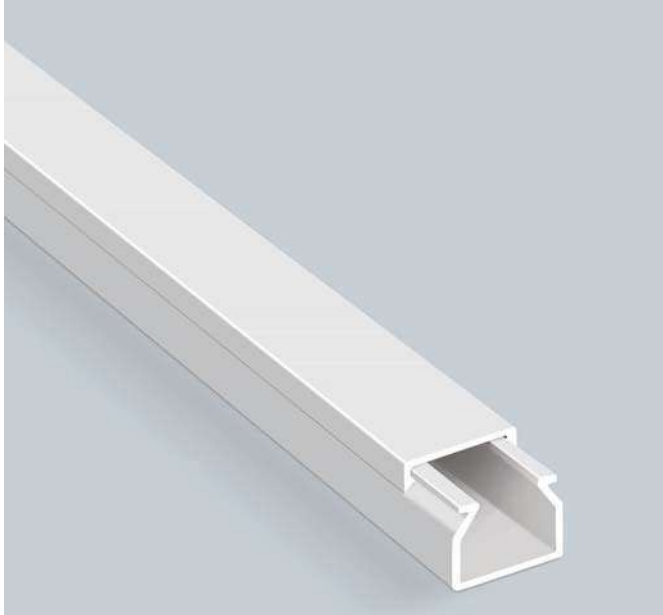

15x10

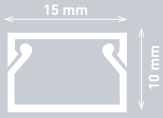

		EKO Serisi Series	MEKS Serisi Series	CANALEX Serisi Series
Ürün Kodu	Product Code	001 014 015010 20 00	001 002 015010 20 00	001 156 015010 20 00
Ambalaj Şekli	Packing Type	Kutu - Box	Kutu - Box	Kutu - Box
Adet / m	Quantity / m	250 m	250 m	250 m
Ağırlık	Weight	19,8 kg	19,8 kg	15,8 kg
m ³ /	Volume	0,053	0,053	0,053

AKSESUARLAR - ACCESSORIES

	Kod Code	Ürün Product	Adet Quantity	Ağırlık Weight	m ³ Volume
	001 039 015010 00 00	İç Köşe Internal Corner	60	0,133 kg	0,006
	001 040 015010 00 00	Dış Köşe External Corner	60	0,176 kg	0,00264
	001 041 015010 00 00	T Köşe T Corner	60	0,230 kg	0,00264
	001 042 015010 00 00	90° L Köşe 90° L Corner	60	0,176 kg	0,00264
	001 043 015010 00 00	Ek Parça Connector	100	0,162 kg	0,00260
	001 044 015010 00 00	Uç Tapa Blind Cap	100	0,152 kg	0,0026

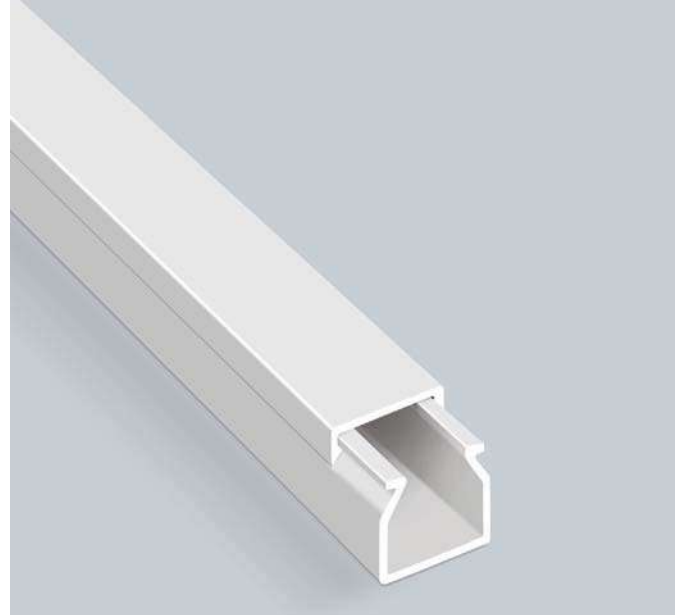

15x15

Aksesuarsız
Without Accessories

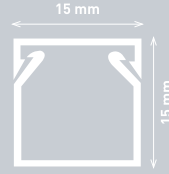

		EKO Serisi Series	MEKS Serisi Series
Ürün Kodu	Product Code	001 014 015015 20 00	001 002 015015 20 00
Ambalaj Şekli	Packing Type	Kutu - Box	Kutu - Box
Adet / m	Quantity / m	250 m	250 m
Ağırlık	Weight	23 kg.	23 kg.
m ³ /	Volume	0,085	0,085



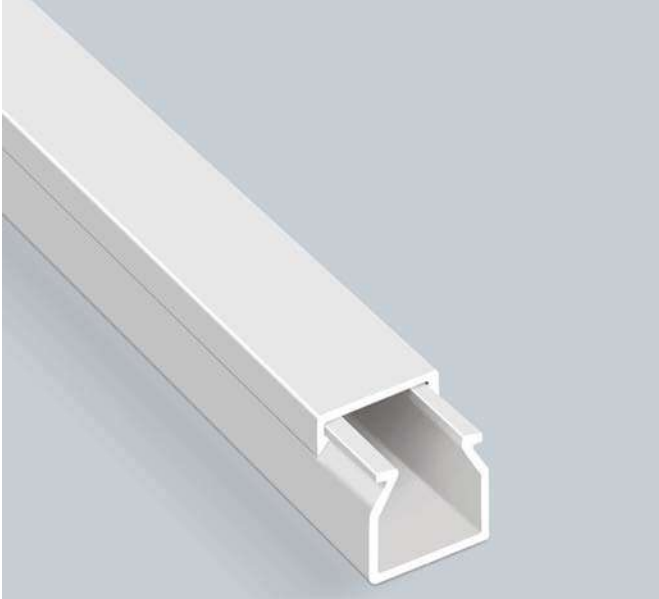

16x16

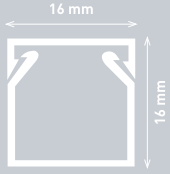

		EKO Serisi Series	MEKS Serisi Series	CANALEX Serisi Series
Ürün Kodu	Product Code	001 014 016016 20 00	001 002 016016 20 00	001 156 016016 20 00
Ambalaj Şekli	Packing Type	Kutu - Box	Kutu - Box	Kutu - Box
Adet / m	Quantity / m	250 m	250 m	250 m
Ağırlık	Weight	27.39 kg	27.39 kg	20.64 kg
m ³ /	Volume	0.07125	0.07125	0.07125

AKSESUARLAR - ACCESSORIES

	Kod Code	Ürün Product	Adet Quantity	Ağırlık Weight	m ³ Volume
	001 039 016016 00 00	İç Köşe Internal Corner	60	0.158 kg	0.0078
	001 040 016016 00 00	Dış Köşe External Corner	60	0.188 kg	0.00294
	001 041 016016 00 00	T Köşe T Corner	60	0.176 kg	0.00294
	001 042 016016 00 00	90° L Köşe 90° L Corner	60	0.242 kg	0.00294
	001 043 016016 00 00	Ek Parça Connector	100	0.192 kg	0.0029
	001 044 016016 00 00	Uç Tapa Blind Cap	100	0.182 kg	0.0029



20x10



		EKO Serisi Series	MEKS Serisi Series	CANALEX Serisi Series
Ürün Kodu	Product Code	001 014 020010 20 00	001 002 020010 20 00	001 156 020010 20 00
Ambalaj Şekli	Packing Type	Kutu - Box	Kutu - Box	Kutu - Box
Adet / m	Quantity / m	200 m	200 m	200 m
Ağırlık	Weight	18.65 kg	18.65 kg	16.65 kg
m ³ /	Volume	0.0502	0.0502	0.0502

AKSESUARLAR - ACCESSORIES

	Kod Code	Ürün Product	Adet Quantity	Ağırlık Weight	m ³ Volume
	001 039 020010 00 00	İç Köşe Internal Corner	60	0.164 kg	0.00126
	001 040 020010 00 00	Dış Köşe External Corner	60	0.170 kg	0.00126
	001 041 020010 00 00	T Köşe T Corner	60	0.139 kg	0.00123
	001 042 020010 00 00	90° L Köşe 90° L Corner	60	0.212 kg	0.00125
	001 043 020010 00 00	Ek Parça Connector	100	0.162 kg	0.00120
	001 044 020010 00 00	Uç Tapa Blind Cap	100	0.152 kg	0.0012



20x15



		EKO Serisi Series	MEKS Serisi Series
Ürün Kodu	Product Code	001 014 020015 20 00	001 156 020015 20 00
Ambalaj Şekli	Packing Type	Kutu - Box	Kutu - Box
Adet / m	Quantity / m	150 m	150 m
Ağırlık	Weight	20.66 kg	18.11 kg
m ³ /	Volume	0.08235	0.08235



20x20 | Aksesuarsız
Without Accessories





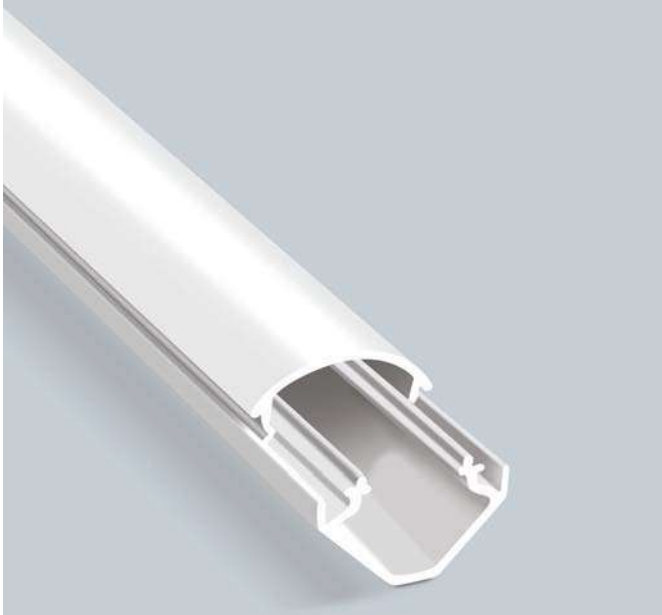
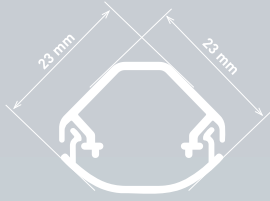

		EKO Serisi Series	MEKS Serisi Series
Ürün Kodu	Product Code	001 014 020020 20 00	001 002 020020 20 00
Ambalaj Şekli	Packing Type	Kutu - Box	Kutu - Box
Adet / m	Quantity / m	144 m	144 m
Ağırlık	Weight	19.16 kg	19.16 kg
m ³ /	Volume	0.07128	0.07128



**23x23****Tavan Köşe Kanalı**
Ceiling Corner Trunking**MEKS** Serisi Series

Ürün Kodu	Product Code	001 002 023023 20 00
Ambalaj Şekli	Packing Type	Kutu - Box
Adet / m	Quantity / m	120 m
Ağırlık	Weight	23.94 kg
m ³ /	Volume	0.07536

AKSESUARLAR - ACCESSORIES

Kod Code	Ürün Product	Adet Quantity	Ağırlık Weight	m ³ Volume
 001 039 023023 00 00	İç Köşe Internal Corner	1	0.013 kg	0.00014
 001 040 023023 00 00	Dış Köşe External Corner	1	0.013 kg	0.00014
 001 041 023023 00 00	T Köşe T Corner	60	0.792 kg	0.00832
 001 042 023023 00 00	90° L Köşe 90° L Corner	60	0.255 kg	0.00293
 001 043 023023 00 00	Ek Parça Connector	100	1.320 kg	0.01386
 001 044 023023 00 00	Uç Tapa Blind Cap	100	0.167 kg	0.01386

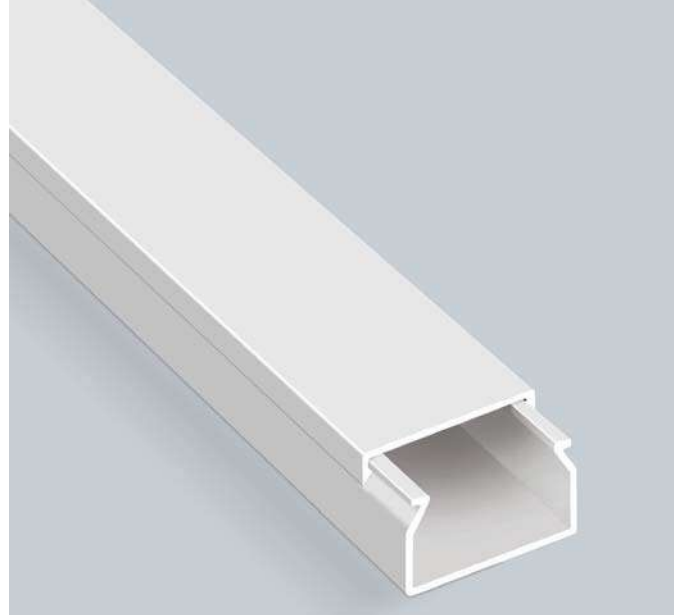
**25x16****EKO** Serisi Series**MEKS** Serisi Series**CANALEX** Serisi Series

Ürün Kodu	Product Code	001 014 025016 20 00	001 002 025016 20 00	001 156 025016 20 00
Ambalaj Şekli	Packing Type	Kutu - Box	Kutu - Box	Kutu - Box
Adet / m	Quantity / m	150 m	150 m	150 m
Ağırlık	Weight	20.66 kg	20.66 kg	18.11 kg
m ³ /	Volume	0.08235	0.08235	0.08235

AKSESUARLAR - ACCESSORIES

Kod Code	Ürün Product	Adet Quantity	Ağırlık Weight	m ³ Volume
 001 039 025016 00 00	İç Köşe Internal Corner	40	0.323 kg	0.00292
 001 040 025016 00 00	Dış Köşe External Corner	40	0.432 kg	0.00260
 001 041 025016 00 00	T Köşe T Corner	30	0.324 kg	0.00260
 001 042 025016 00 00	90° L Köşe 90° L Corner	50	0.434 kg	0.00260
 001 043 025016 00 00	Ek Parça Connector	100	0.212 kg	0.00260
 001 044 025016 00 00	Uç Tapa Blind Cap	100	0.182 kg	0.00260
 001 047 025016 00 00	PM Kasası 1 li Socket Assembly Frame Single	12	1.161 kg	0.00731

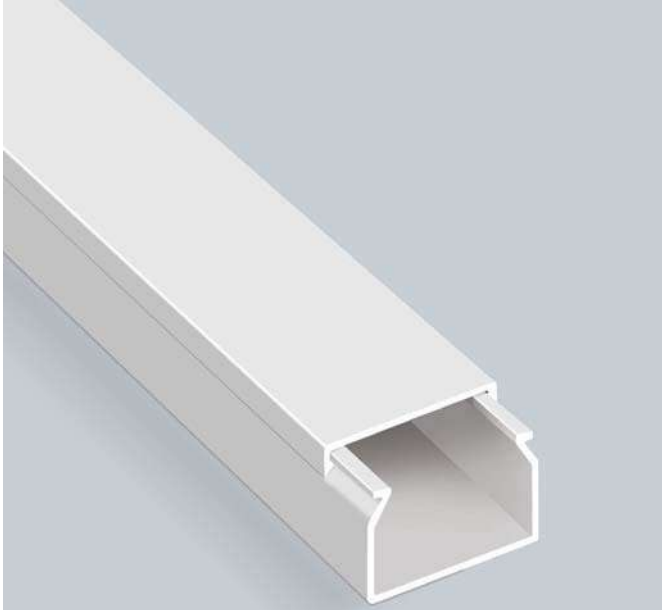

25x25

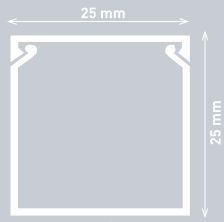

		EKO Serisi Series	MEKS Serisi Series	CANALEX Serisi Series
Ürün Kodu	Product Code	001 014 025025 20 00	001 002 025025 20 00	001 156 025025 20 00
Ambalaj Şekli	Packing Type	Kutu - Box	Kutu - Box	Kutu - Box
Adet / m	Quantity / m	100 m	100 m	100 m
Ağırlık	Weight	20.16 kg	20.16 kg	17.36 kg
m ³ /	Volume	0.07820	0.07820	0.7820

AKSESUARLAR - ACCESSORIES

	Kod Code	Ürün Product	Adet Quantity	Ağırlık Weight	m ³ Volume
	001 039 025025 00 00	İç Köşe Internal Corner	40	0.343 kg	0.00292
	001 040 025025 00 00	Dış Köşe External Corner	40	0.448 kg	0.00260
	001 041 025025 00 00	T Köşe T Corner	30	0.327 kg	0.00260
	001 042 025025 00 00	90° L Köşe 90° L Corner	50	0.448 kg	0.00260
	001 043 025025 00 00	Ek Parça Connector	100	0.126 kg	0.00260
	001 044 025025 00 00	Uç Tapa Blind Cap	100	0.263 kg	0.00260
	001 047 025025 00 00	PM Kasası 1'li Socket Assembly Frame Single	12	1.161 kg	0.00731

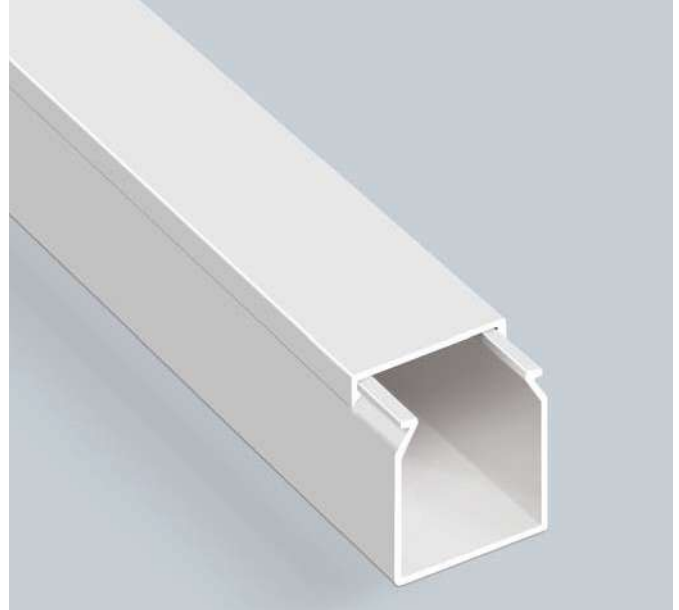

25x40

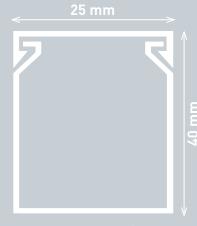

Aksesuarsız
Without Accessories

		EKO Serisi Series	MEKS Serisi Series
Ürün Kodu	Product Code	001 014 025040 20 00	001 002 025040 20 00
Ambalaj Şekli	Packing Type	Kutu - Box	Kutu - Box
Adet / m	Quantity / m	80 m	80 m
Ağırlık	Weight	24.843 kg	24.843 kg
m ³ /	Volume	0.09664	0.09664

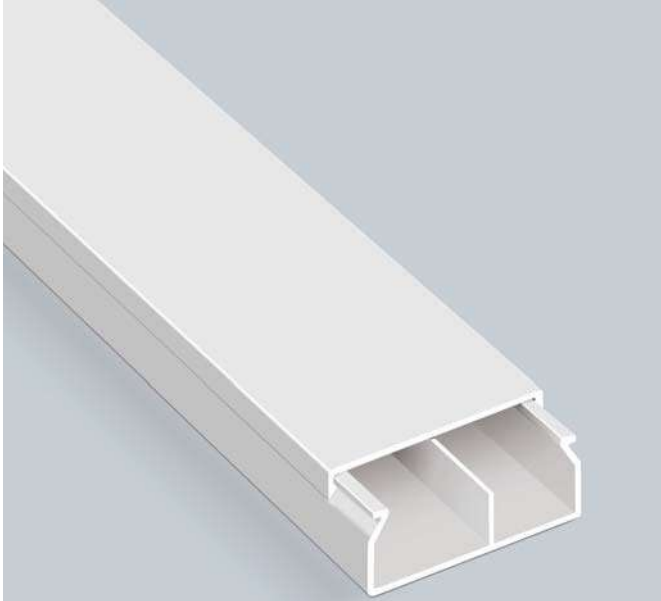
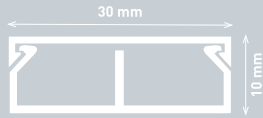

**30x10****Bölmeli**
Partitioned

		EKO Serisi Series	MEKS Serisi Series
Ürün Kodu	Product Code	001 014 930010 20 00	001 002 930010 20 00
Ambalaj Şekli	Packing Type	Kutu - Box	Kutu - Box
Adet / m	Quantity / m	140 m	140 m
Ağırlık	Weight	19.25 kg	19.25 kg
m ³ /	Volume	0.05026	0.05026

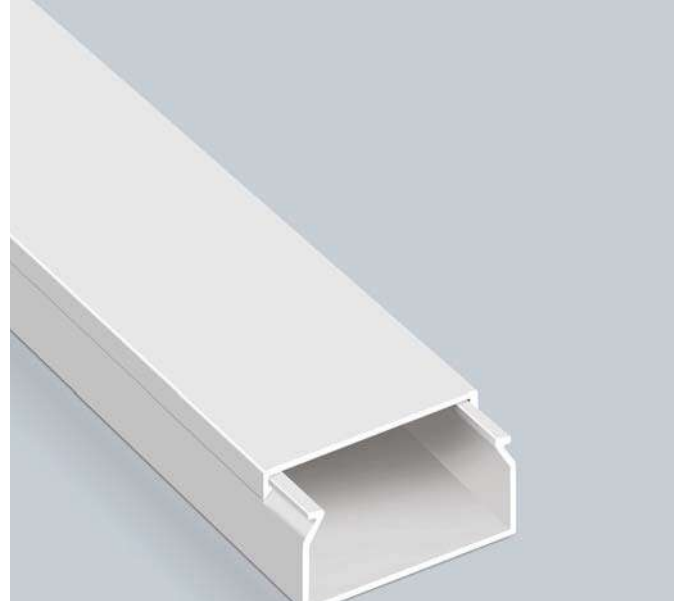
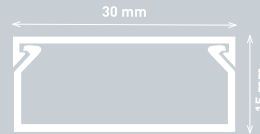
**30x15****Aksesuarsız**
Without Accessories

		EKO Serisi Series	MEKS Serisi Series
Ürün Kodu	Product Code	001 014 030015 20 00	001 002 030015 20 00
Ambalaj Şekli	Packing Type	Kutu - Box	Kutu - Box
Adet / m	Quantity / m	140 m	140 m
Ağırlık	Weight	21.84 kg	21.84 kg
m ³ /	Volume	0.0089	0.0089

AKSESUARLAR - ACCESSORIES

	Kod Code	Ürün Product	Adet Quantity	Ağırlık Weight	m ³ Volume
	001 039 030010 00 00	İç Köşe Internal Corner	50	0.414 kg	0.00295
	001 040 030010 00 00	Dış Köşe External Corner	50	0.419 kg	0.00260
	001 041 030010 00 00	T Köşe T Corner	40	0.420 kg	0.00260
	001 042 030010 00 00	90° L Köşe 90° L Corner	50	0.419 kg	0.00260
	001 043 030025 00 00	Ek Parça Connector	100	0.202 kg	0.00260
	001 044 030025 00 00	Uç Tapa Blind Cap	100	0.202 kg	0.00260



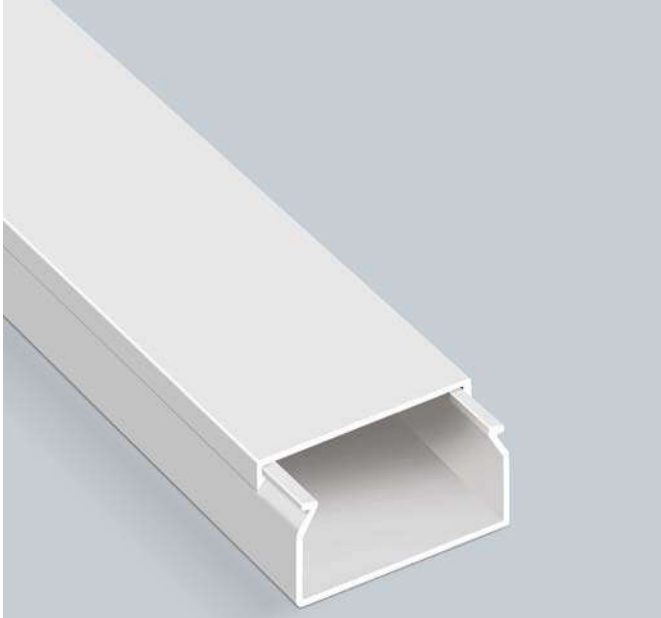
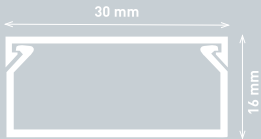

30x16

		EKO Serisi Series	MEKS Serisi Series	CANALEX Serisi Series
Ürün Kodu	Product Code	001 014 030016 20 00	001 002 030016 20 00	001 156 030016 20 00
Ambalaj Şekli	Packing Type	Kutu - Box	Kutu - Box	Kutu - Box
Adet / m	Quantity / m	140 m	140 m	140 m
Ağırlık	Weight	21.46 kg	21.46 kg	21.46 kg
m ³ /	Volume	0.07532	0.07532	0.07532

AKSESUARLAR - ACCESSORIES

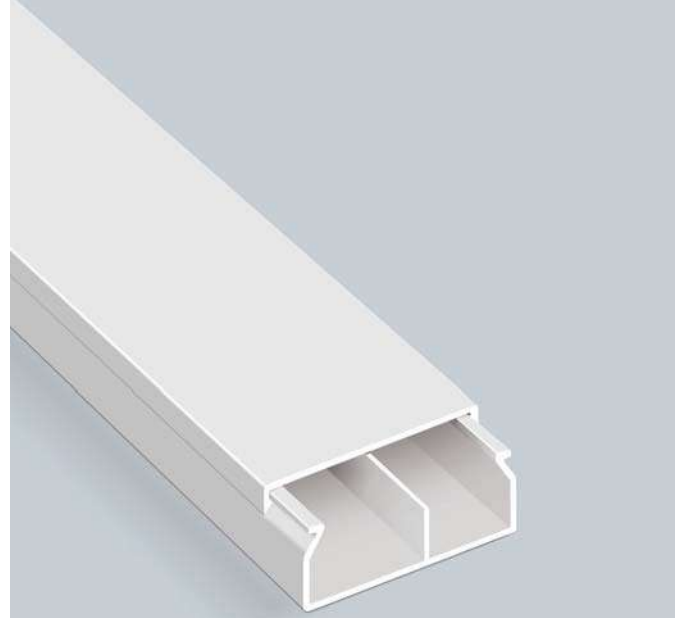
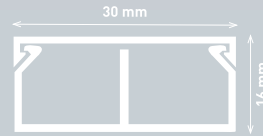
	Kod Code	Ürün Product	Adet Quantity	Ağırlık Weight	m ³ Volume
	001 039 030016 00 00	İç Köşe Internal Corner	35	0.350 kg	0.00294
	001 040 030016 00 00	Dış Köşe External Corner	48	0.412 kg	0.00260
	001 041 030016 00 00	T Köşe T Corner	40	0.497 kg	0.00260
	001 042 030016 00 00	90° L Köşe 90° L Corner	50	0.475 kg	0.00260
	001 043 030025 00 00	Ek Parça Connector	100	0.232 kg	0.0014
	001 044 030025 00 00	Uç Tapa Blind Cap	100	0.303 kg	0.00260
	001 047 030016 00 00	PM Kasası 1'li Socket Assembly Frame Single	12	1.161 kg	0.00731

30x16
Bölmeli
Partitioned

		EKO Serisi Series	MEKS Serisi Series
Ürün Kodu	Product Code	001 014 030015 20 00	001 002 030015 20 00
Ambalaj Şekli	Packing Type	Kutu - Box	Kutu - Box
Adet / m	Quantity / m	140 m	140 m
Ağırlık	Weight	22.86 kg	22.86 kg
m ³ /	Volume	0.07812	0.07812

AKSESUARLAR - ACCESSORIES

	Kod Code	Ürün Product	Adet Quantity	Ağırlık Weight	m ³ Volume
	001 039 030016 00 00	İç Köşe Internal Corner	35	0.350 kg	0.00294
	001 040 030016 00 00	Dış Köşe External Corner	48	0.412 kg	0.00260
	001 041 030016 00 00	T Köşe T Corner	40	0.497 kg	0.00260
	001 042 030016 00 00	90° L Köşe 90° L Corner	50	0.475 kg	0.00260
	001 043 030025 00 00	Ek Parça Connector	100	0.232 kg	0.0014
	001 044 030025 00 00	Uç Tapa Blind Cap	100	0.303 kg	0.00260
	001 047 030016 00 00	PM Kasası 1'li Socket Assembly Frame Single	12	1.161 kg	0.00731

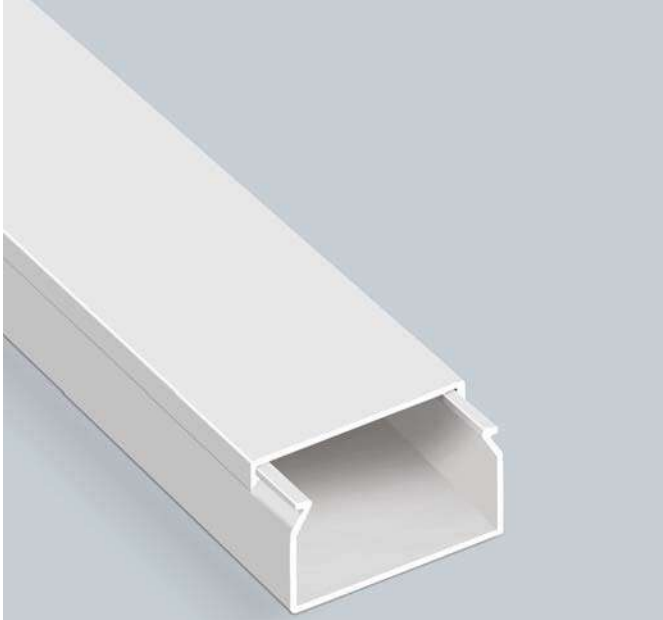

30x25



		EKO <small>Serisi Series</small>	MEKS <small>Serisi Series</small>
Ürün Kodu	Product Code	001 014 030025 20 00	001 002 030025 20 00
Ambalaj Şekli	Packing Type	Kutu - Box	Kutu - Box
Adet / m	Quantity / m	80 m	80 m
Ağırlık	Weight	16.34 kg	16.34 kg
m ³ /	Volume	0.07256	0.07256

AKSESUARLAR - ACCESSORIES

	Kod Code	Ürün Product	Adet Quantity	Ağırlık Weight	m ³ Volume
	001 039 030025 00 00	İç Köşe Internal Corner	32	0.401 kg	0.00291
	001 040 030025 00 00	Dış Köşe External Corner	30	0.470 kg	0.00260
	001 041 030025 00 00	T Köşe T Corner	24	0.381 kg	0.00260
	001 042 030025 00 00	90° L Köşe 90° L Corner	30	0.355 kg	0.00260
	001 043 030025 00 00	Ek Parça Connector	100	0.263kg	0.00260
	001 044 030025 00 00	Uç Tapa Blind Cap	100	0.364 kg	0.00260
	001 047 017421 00 00	PM Kasası 1'li Socket Assembly Frame Single	12	1.161 kg	0.00731

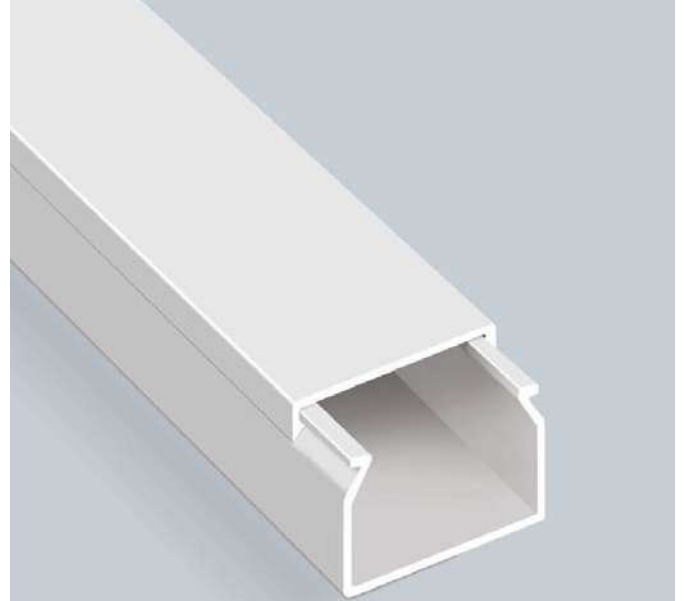

30x30

Aksesuarsız
Without Accessories

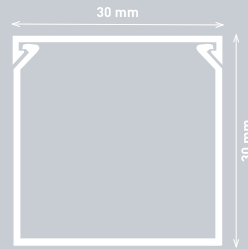

		EKO <small>Serisi Series</small>	MEKS <small>Serisi Series</small>
Ürün Kodu	Product Code	001 014 030030 20 00	001 002 030030 20 00
Ambalaj Şekli	Packing Type	Kutu - Box	Kutu - Box
Adet / m	Quantity / m	80 m	80 m
Ağırlık	Weight	19.24 kg	19.24 kg
m ³ /	Volume	0.032	0.032





40x16

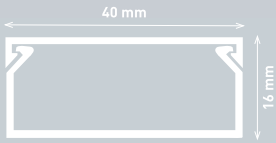

		EKO Serisi Series	MEKS Serisi Series	CANALEX Serisi Series
Ürün Kodu	Product Code	001 014 040016 20 00	001 002 040016 20 00	001 156 040016 20 00
Ambalaj Şekli	Packing Type	Kutu - Box	Kutu - Box	Kutu - Box
Adet / m	Quantity / m	100 m	100 m	100 m
Ağırlık	Weight	20.16 kg	20.16 kg	17.66 kg
m ³ /	Volume	0.08090	0.08090	0.08090

AKSESUARLAR - ACCESSORIES

	Kod Code	Ürün Product	Adet Quantity	Ağırlık Weight	m ³ Volume
	001 039 040016 00 00	İç Köşe Internal Corner	32	0.375 kg	0.00979
	001 040 040016 00 00	Dış Köşe External Corner	30	0.970 kg	0.00240
	001 041 040016 00 00	T Köşe T Corner	24	0.402 kg	0.00730
	001 042 040016 00 00	90° L Köşe 90° L Corner	34	0.446 kg	0.00730
	001 043 040040 00 00	Ek Parça Connector	100	0.404 kg	0.00730
	001 044 040040 00 00	Uç Tapa Blind Cap	25	0.093 kg	0.00730
	001 047 040016 00 00	PM Kasası 1'li Socket Assembly Frame Single	12	1.161 kg	0.00731

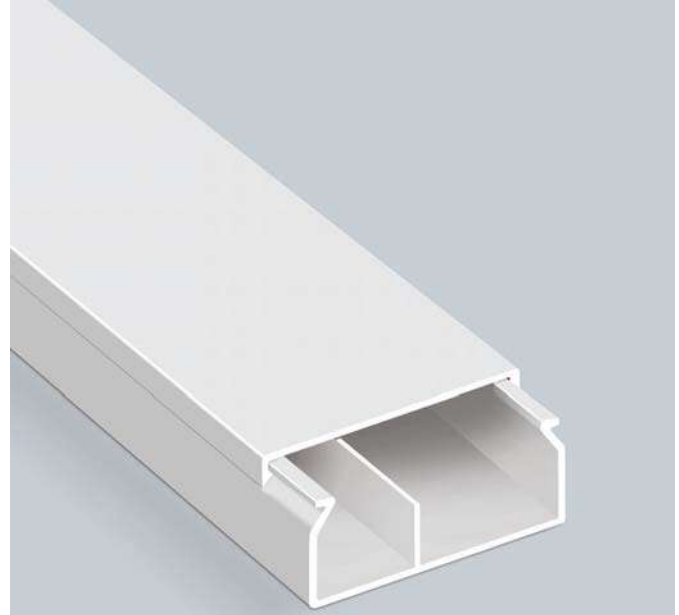

40x16

Bölmeli
Partitioned

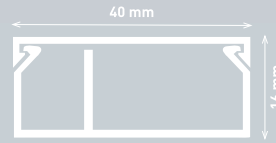

		EKO Serisi Series	MEKS Serisi Series
Ürün Kodu	Product Code	001 014 940016 20 00	001 002 940016 20 00
Ambalaj Şekli	Packing Type	Kutu - Box	Kutu - Box
Adet / m	Quantity / m	100 m	100 m
Ağırlık	Weight	23.16 kg	23.16 kg
m ³ /	Volume	0.0767	0.0767

AKSESUARLAR - ACCESSORIES

	Kod Code	Ürün Product	Adet Quantity	Ağırlık Weight	m ³ Volume
	001 039 040016 00 00	İç Köşe Internal Corner	32	0.375 kg	0.00979
	001 040 040016 00 00	Dış Köşe External Corner	30	0.970 kg	0.00240
	001 041 040016 00 00	T Köşe T Corner	24	0.402 kg	0.00730
	001 042 040016 00 00	90° L Köşe 90° L Corner	34	0.446 kg	0.00730
	001 043 040040 00 00	Ek Parça Connector	100	0.404 kg	0.00730
	001 044 040040 00 00	Uç Tapa Blind Cap	25	0.093 kg	0.00730
	001 047 040016 00 00	PM Kasası 1'li Socket Assembly Frame Single	12	1.161 kg	0.00731

**40x17****Tam Kapaklı - Full Cover**
Aksesuarsız - Without Accessories**MEKS** Serisi Series

Ürün Kodu	Product Code	001 002 040017 20 00
Ambalaj Şekli	Packing Type	Kutu - Box
Adet / m	Quantity / m	100 m
Ağırlık	Weight	26.16 kg
m ³ /	Volume	0.0809

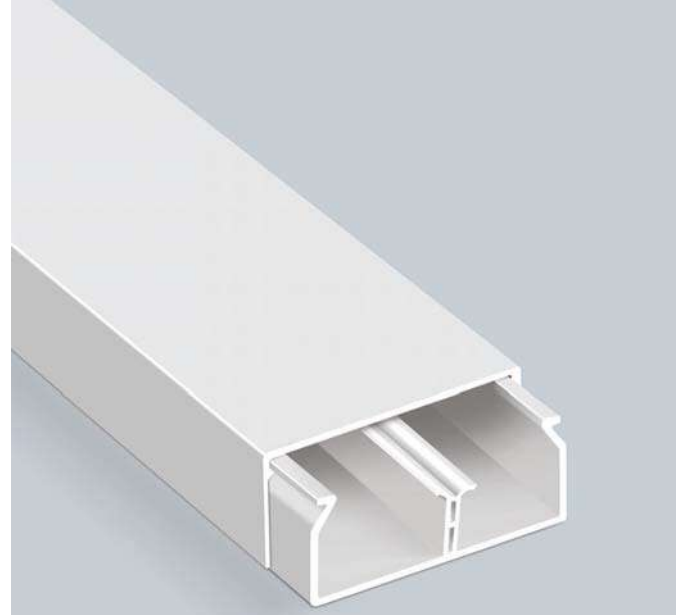
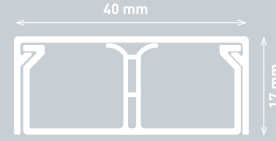
**40x17****Tam Kapaklı Bölmeli**
Full Cover and Partitioned
Aksesuarsız
Without Accessories**MEKS** Serisi Series

Ürün Kodu	Product Code	001 002 940017 20 00
Ambalaj Şekli	Packing Type	Kutu - Box
Adet / m	Quantity / m	100 m
Ağırlık	Weight	26.16 kg
m ³ /	Volume	0.0809



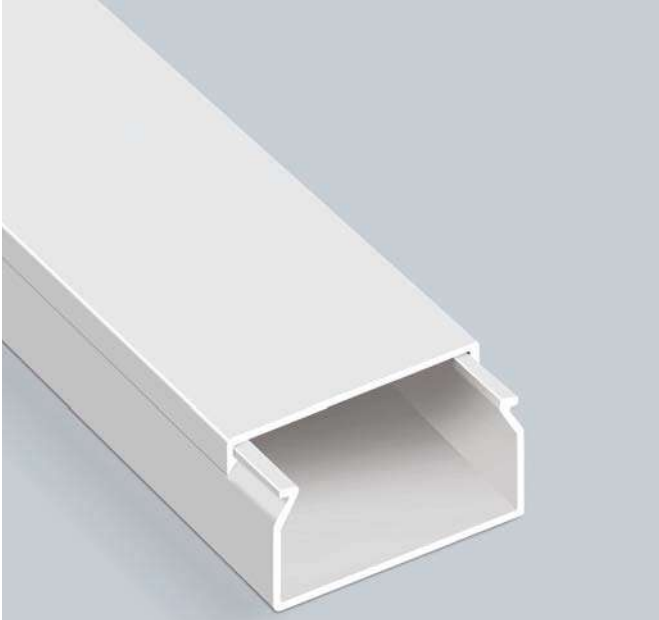
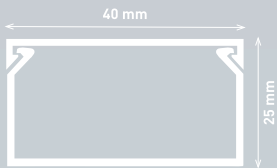

40x25

		EKO Serisi Series	MEKS Serisi Series	CANALEX Serisi Series
Ürün Kodu	Product Code	001 014 040025 20 00	001 002 040025 20 00	001 156 040025 20 00
Ambalaj Şekli	Packing Type	Kutu - Box	Kutu - Box	Kutu - Box
Adet / m	Quantity / m	80 m	80 m	80 m
Ağırlık	Weight	22.043 kg	22.043 kg	17.243 kg
m ³ /	Volume	0.09592	0.09592	0.09592

AKSESUARLAR - ACCESSORIES

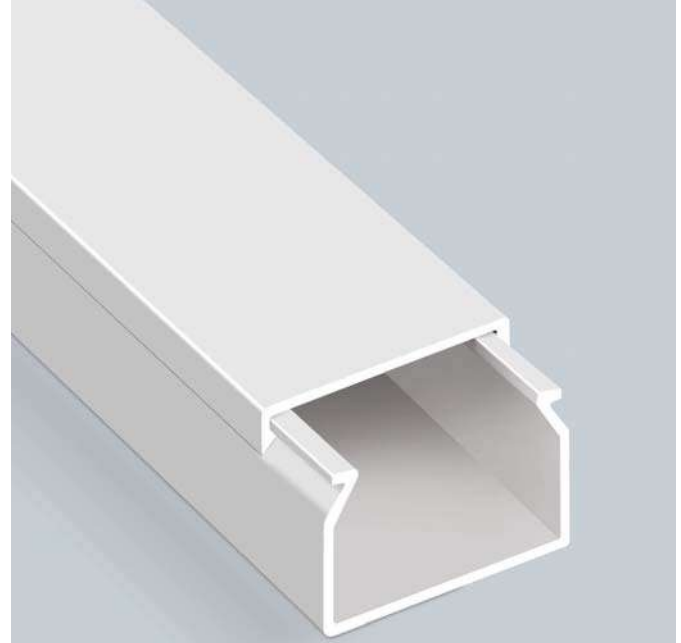
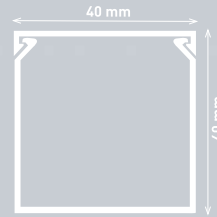
	Kod Code	Ürün Product	Adet Quantity	Ağırlık Weight	m ³ Volume
	001 039 040025 00 00	İç Köşe Internal Corner	24	0.354 kg	0.01044
	001 040 040025 00 00	Dış Köşe External Corner	30	0.691 kg	0.00272
	001 041 040025 00 00	T Köşe T Corner	18	0.345 kg	0.00731
	001 042 040025 00 00	90° L Köşe 90° L Corner	24	0.376 kg	0.00272
	001 043 040040 00 00	Ek Parça Connector	70	0.283 kg	0.00728
	001 044 040040 00 00	Uç Tapa Blind Cap	25	0.152 kg	0.00128
	001 047 040025 00 00	PM Kasası 1'li Socket Assembly Frame Single	12	1.161 kg	0.00731

40x40

		EKO Serisi Series	MEKS Serisi Series	CANALEX Serisi Series
Ürün Kodu	Product Code	001 014 040040 20 00	001 002 040040 20 00	001 156 040040 20 00
Ambalaj Şekli	Packing Type	Kutu - Box	Kutu - Box	Kutu - Box
Adet / m	Quantity / m	50 m	50 m	50 m
Ağırlık	Weight	16.743 kg	16.743 kg	15.743 kg
m ³ /	Volume	0.10230	0.10230	0.10230

AKSESUARLAR - ACCESSORIES

	Kod Code	Ürün Product	Adet Quantity	Ağırlık Weight	m ³ Volume
	001 039 040040 00 00	İç Köşe Internal Corner	18	0.441 kg	0.010458
	001 040 040040 00 00	Dış Köşe External Corner	10	0.290 kg	0.00272
	001 041 040040 00 00	T Köşe T Corner	48	1.265 kg	0.0073
	001 042 040040 00 00	90° L Köşe 90° L Corner	60	1.260 kg	0.0073
	001 043 040040 00 00	Ek Parça Connector	100	0.434 kg	0.0073
	001 044 040040 00 00	Uç Tapa Blind Cap	25	0.146 kg	0.0073

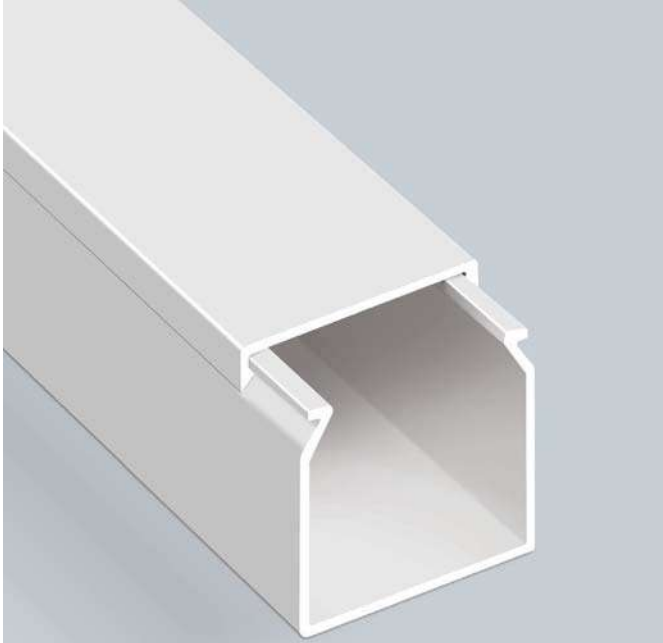
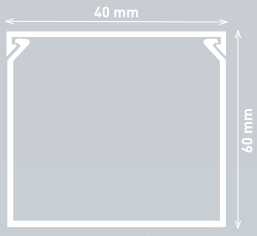
**40x60****Aksesuarsız**
Without Accessories**EKO** Serisi Series**MEKS** Serisi Series

Ürün Kodu	Product Code	001 014 040060 20 00	001 002 040060 20 00
Ambalaj Şekli	Packing Type	Kutu - Box	Kutu - Box
Adet / m	Quantity / m	40 m	40 m
Ağırlık	Weight	21.518 kg	21.518 kg
m ³ /	Volume	0.11216	0.11216

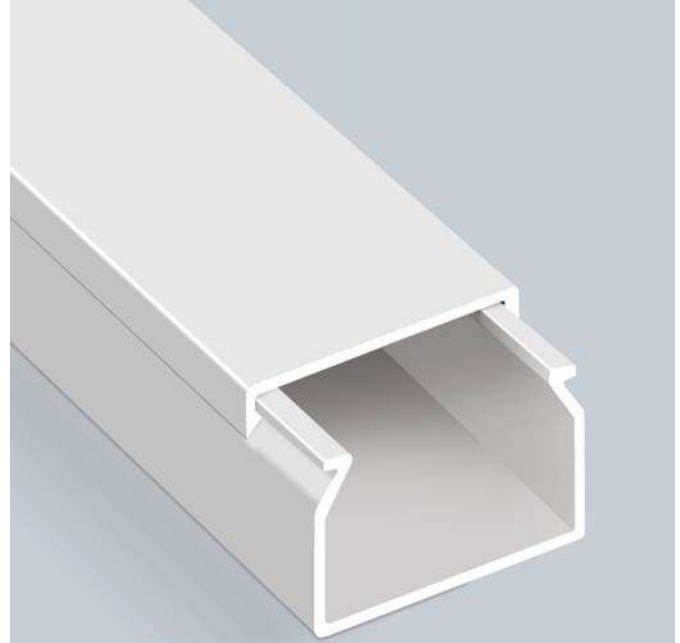
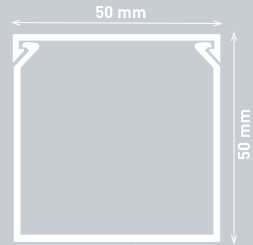
**50x50****Aksesuarsız**
Without Accessories**EKO** Serisi Series

Ürün Kodu	Product Code	001 014 050050 20 00
Ambalaj Şekli	Packing Type	Kutu - Box
Adet / m	Quantity / m	30 m
Ağırlık	Weight	13.243 kg
m ³ /	Volume	0.09663



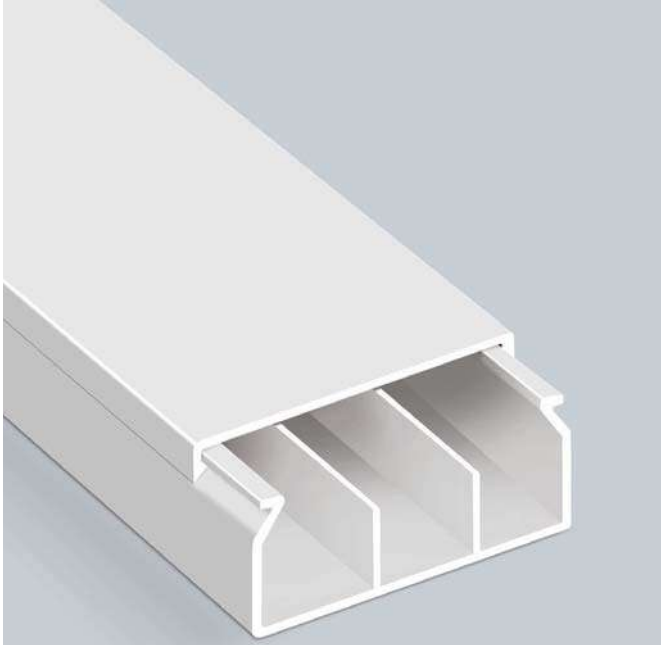

60x25

Bölmeli
Partitioned

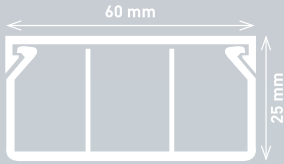

		EKO Serisi Series	MEKS Serisi Series
Ürün Kodu	Product Code	001 014 960025 20 00	001 002 960025 20 00
Ambalaj Şekli	Packing Type	Kutu - Box	Kutu - Box
Adet / m	Quantity / m	40 m	40 m
Ağırlık	Weight	17.14 kg	17.14 kg
m ³ /	Volume	0.07264	0.07264

AKSESUARLAR - ACCESSORIES

	Kod Code	Ürün Product	Adet Quantity	Ağırlık Weight	m ³ Volume
	001 039 060025 00 00	İç Köşe Internal Corner	48	1.018 kg	0.00984
	001 040 060025 00 00	Dış Köşe External Corner	72	1.454 kg	0.00984
	001 041 060025 00 00	T Köşe T Corner	40	2.089 kg	0.00984
	001 042 060025 00 00	90° L Köşe 90° L Corner	60	2.042 kg	0.00984
	001 043 060060 00 00	Ek Parça Connector	60	0.455 kg	0.00272
	001 044 060025 00 00	Uç Tapa Blind Cap	50	0.434 kg	0.00272
	001 047 017421 00 00	PM Kasası 1'li Socket Assembly Frame Single	12	1.161 kg	0.00731

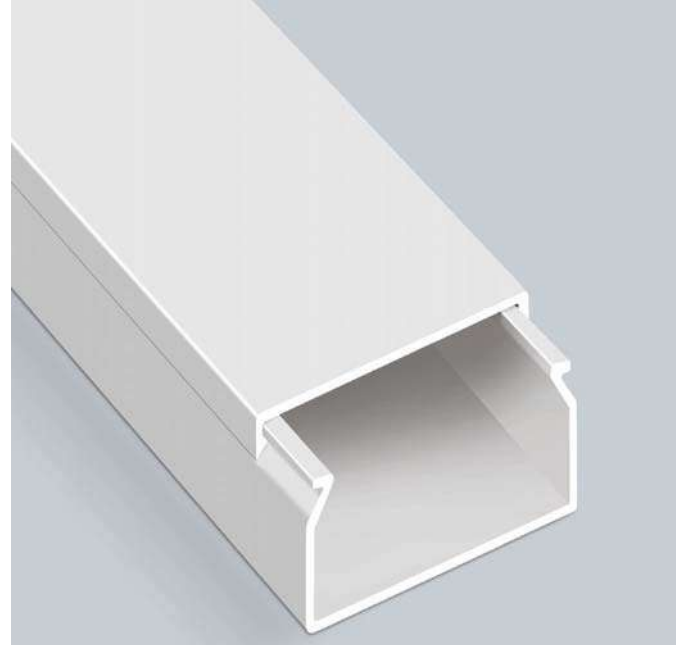

60x40



		EKO Serisi Series	MEKS Serisi Series	CANALEX Serisi Series
Ürün Kodu	Product Code	001 014 060040 20 00	001 002 060040 20 00	001 156 060040 20 00
Ambalaj Şekli	Packing Type	Kutu - Box	Kutu - Box	Kutu - Box
Adet / m	Quantity / m	40 m	40 m	40 m
Ağırlık	Weight	21.118 kg	21.118 kg	15.518 kg
m ³ /	Volume	0.11084	0.11084	0.11084

AKSESUARLAR - ACCESSORIES

	Kod Code	Ürün Product	Adet Quantity	Ağırlık Weight	m ³ Volume
	001 039 060040 00 00	İç Köşe Internal Corner	26	0.441 kg	0.00985
	001 040 060040 00 00	Dış Köşe External Corner	32	0.290 kg	0.01011
	001 041 060040 00 00	T Köşe T Corner	32	1.265 kg	0.00986
	001 042 060040 00 00	90° L Köşe 90° L Corner	40	1.260 kg	0.01011
	001 043 060060 00 00	Ek Parça Connector	40	0.434 kg	0.00272
	001 044 060040 00 00	Uç Tapa Blind Cap	50	0.146 kg	0.00272

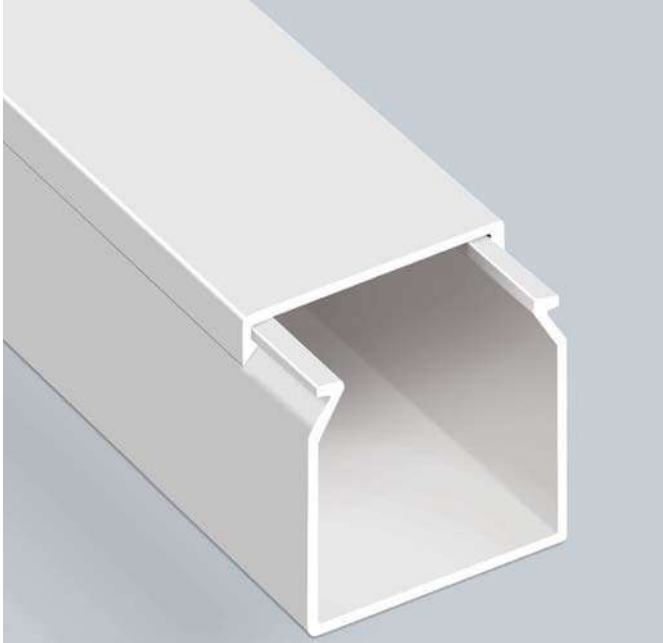
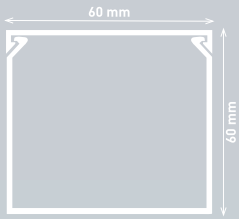
**60x60**

EKO	MEKS	CANALEX
Serisi Series	Serisi Series	Serisi Series

Ürün Kodu	Product Code	001 014 060060 20 00	001 002 060060 20 00	001 156 060060 20 00
Ambalaj Şekli	Packing Type	Kutu - Box	Kutu - Box	Kutu - Box
Adet / m	Quantity / m	32 m	32 m	32 m
Ağırlık	Weight	20.957 kg	20.957 kg	18.717 kg
m ³ /	Volume	0.13590	0.13590	0.13590

AKSESUARLAR - ACCESSORIES

Kod	Ürün	Adet	Ağırlık	m ³
Code	Product	Quantity	Weight	Volume
 001 039 060060 01 00	Hareketli İç Köşe Internal Corner Live	16	0.441 kg	0.00939
 001 040 060060 01 00	Hareketli Dış Köşe External Corner Live	16	0.290 kg	0.01011
 001 041 060060 00 00	T Köşe T Corner	20	1.265 kg	0.01044
 001 042 060060 00 00	90° L Köşe 90° L Corner	24	1.260 kg	0.01044
 001 043 060060 00 00	Ek Parça Connector	25	0.434 kg	0.01045
 001 044 060060 00 00	Uç Tapa Blind Cap	30	0.146 kg	0.01044

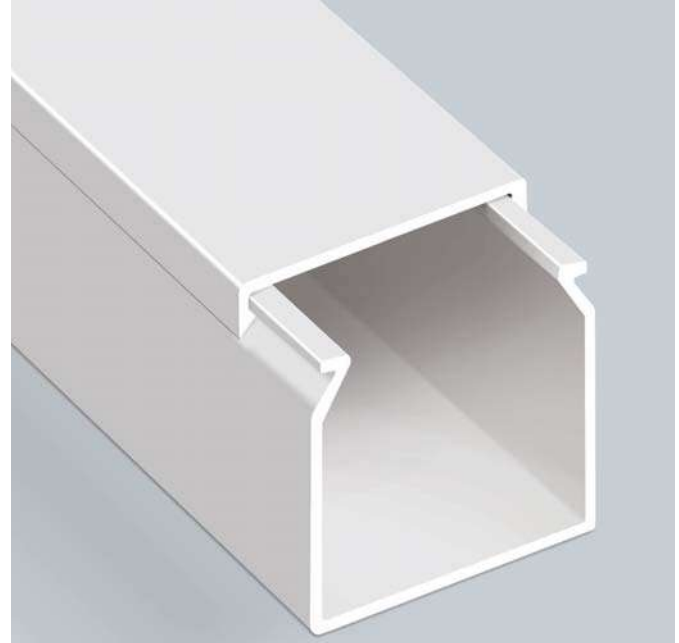
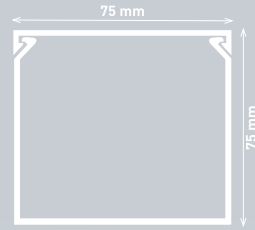
**75x75****Aksesuarsız**
Without Accessories**EKO** Serisi Series

Ürün Kodu	Product Code	001 014 075075 20 00
Ambalaj Şekli	Packing Type	Kutu - Box
Adet / m	Quantity / m	28 m
Ağırlık	Weight	25.993
m ³ /	Volume	0.17357



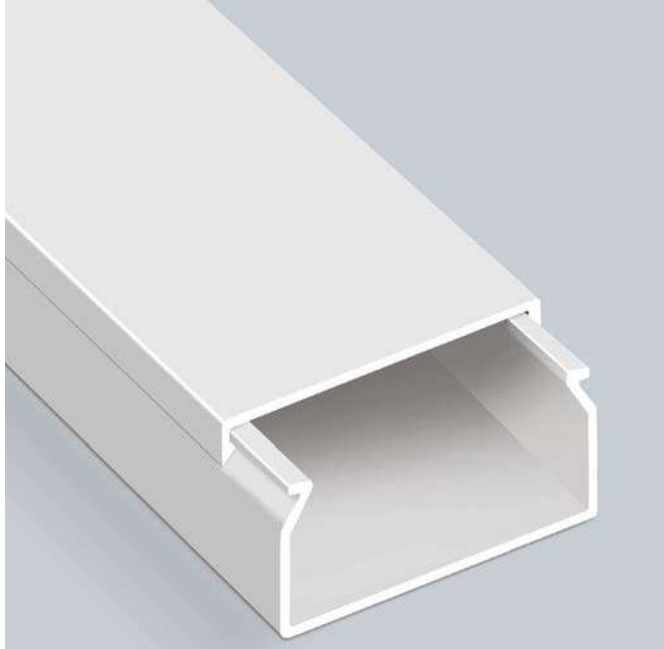

80x40

		EKO Serisi Series	MEKS Serisi Series	CANALEX Serisi Series
Ürün Kodu	Product Code	001 014 060060 20 00	001 002 060060 20 00	001 156 060060 20 00
Ambalaj Şekli	Packing Type	Kutu - Box	Kutu - Box	Kutu - Box
Adet / m	Quantity / m	30 m	30 m	30 m
Ağırlık	Weight	19.518 kg	19.518 kg	17.118 kg
m ³ /	Volume	0.11217	0.11217	0.11217

AKSESUARLAR - ACCESSORIES

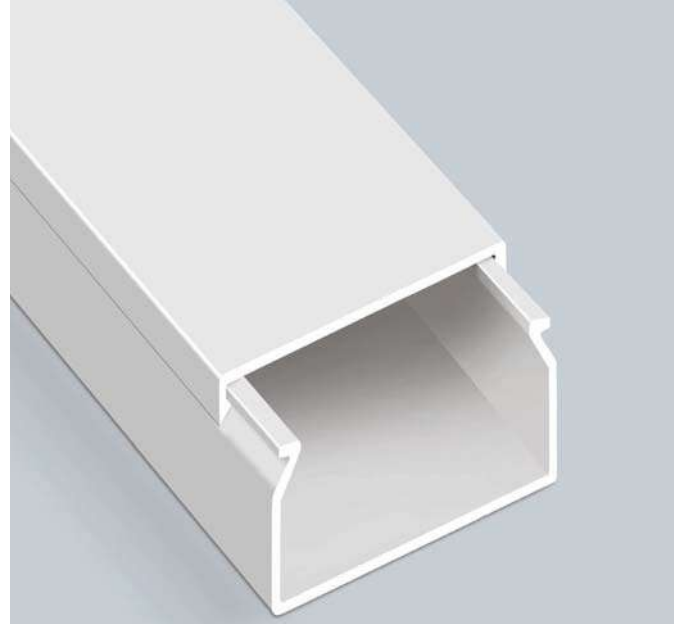
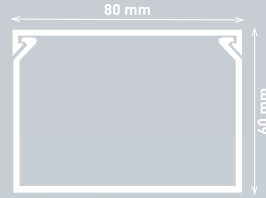
	Kod Code	Ürün Product	Adet Quantity	Ağırlık Weight	m ³ Volume
	001 039 080040 00 00	İç Köşe Internal Corner	18	0.441 kg	0.01046
	001 040 080040 00 00	Dış Köşe External Corner	8	0.290 kg	0.01046
	001 041 080040 00 00	T Köşe T Corner	12	1.265 kg	0.01046
	001 042 080040 00 00	90° L Köşe 90° L Corner	16	1.260 kg	0.01046
	001 043 080040 00 00	Ek Parça Connector	100	0.434 kg	0.01046
	001 044 080040 00 00	Uç Tapa Blind Cap	60	0.146 kg	0.01046

80x60

		EKO Serisi Series	MEKS Serisi Series	CANALEX Serisi Series
Ürün Kodu	Product Code	001 014 080060 20 00	001 002 080060 20 00	001 156 080060 20 00
Ambalaj Şekli	Packing Type	Kutu - Box	Kutu - Box	Kutu - Box
Adet / m	Quantity / m	24 m	24 m	24 m
Ağırlık	Weight	18.557 kg	18.557 kg	16.157 kg
m ³ /	Volume	0.13591	0.13591	0.13591

AKSESUARLAR - ACCESSORIES

	Kod Code	Ürün Product	Adet Quantity	Ağırlık Weight	m ³ Volume
	001 039 080060 00 00	İç Köşe Internal Corner	18	0.441 kg	0.00939
	001 040 080060 00 00	Dış Köşe External Corner	8	0.290 kg	0.01045
	001 041 080060 00 00	T Köşe T Corner	8	1.265 kg	0.00809
	001 042 080060 00 00	90° L Köşe 90° L Corner	10	1.260 kg	0.00842
	001 043 080060 00 00	Ek Parça Connector	80	0.434 kg	0.01011
	001 044 080060 00 00	Uç Tapa Blind Cap	48	0.146 kg	0.01046

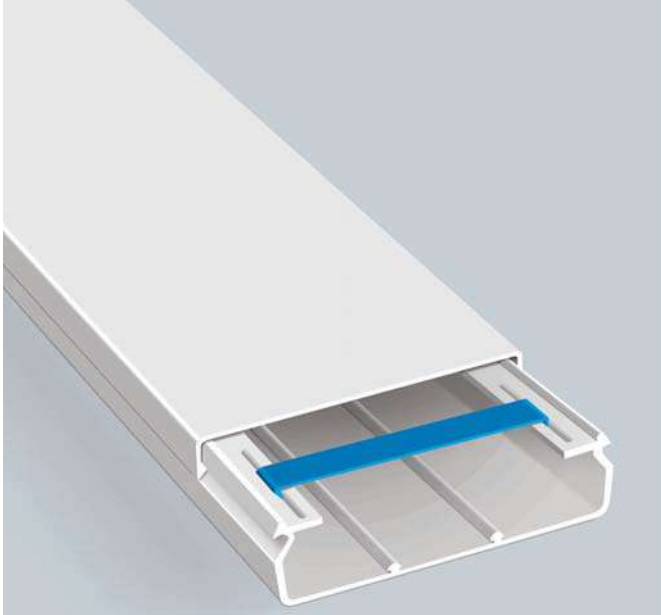
**100x36****Kilitleme Aparatlı**
With Locking Apparatus**MEKS** Serisi Series

Ürün Kodu	Product Code	001 002 100036 20 00
Ambalaj Şekli	Packing Type	Kutu - Box
Adet / m	Quantity / m	30 m
Ağırlık	Weight	31.307 kg
m ³ /	Volume	0.13722

AKSESUARLAR - ACCESSORIES

Kod Code	Ürün Product	Adet Quantity	Ağırlık Weight	m ³ Volume
 001 013 100036 00 00	Ara Bölme Partition	200 m	20.400 kg	0.054
 001 039 100036 00 00	İç Köşe Internal Corner	8	0.583 kg	0.01045
 001 039 100040 01 00	İç Köşe Hareketli Internal Corner Live	8	0.182 kg	0.01045
 001 040 100040 00 00	Dış Köşe External Corner	8	0.691 kg	0.01045
 001 040 100036 01 00	Dış Köşe Hareketli External Corner Live	8	0.764 kg	0.01045
 001 041 100036 00 00	T Köşe T Corner	12	1.056 kg	0.01045
 001 042 100036 00 00	90° L Köşe 90° L Corner	12	1.006 kg	0.01045
 001 043 100060 00 00	Ek Parça Connector	100	0.899	0.01050
 001 044 100060 00 00	Uç Tapa Blind Cap	20	0.5407 kg	0.01045
 001 050 030004 00 00	Kilitleme Aparatı Locking Apparatus	-	-	-

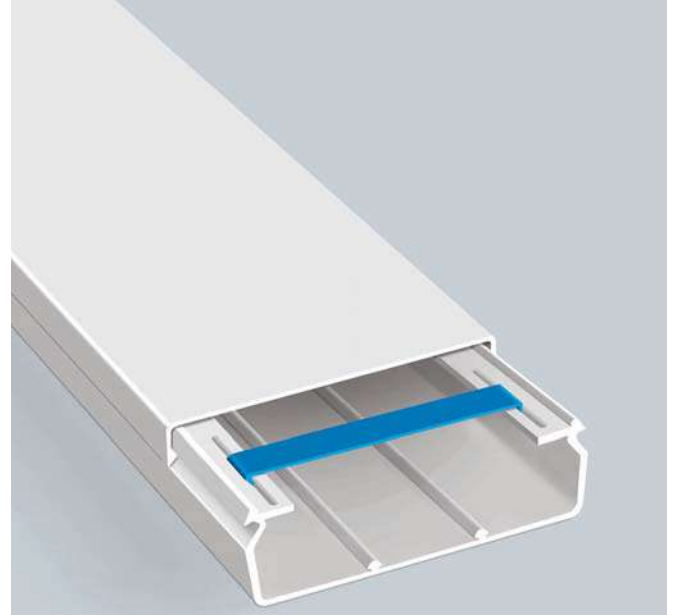
**100x40****Kilitleme Aparatlı**
With Locking Apparatus**EKO** Serisi Series | **MEKS** Serisi Series | **CANALEX** Serisi Series

Ürün Kodu	Product Code	001 014 100040 20 00	001 002 100040 20 00	001 156 100040 20 00
Ambalaj Şekli	Packing Type	Kutu - Box	Kutu - Box	Kutu - Box
Adet / m	Quantity / m	24 m	24 m	24 m
Ağırlık	Weight	21.678 kg	24.318 kg	17.118 kg
m ³ /	Volume	0.11348	0.11348	0.11348

AKSESUARLAR - ACCESSORIES

Kod Code	Ürün Product	Adet Quantity	Ağırlık Weight	m ³ Volume
 001 013 100040 00 00	Ara Bölme Partition	200 m	21.050 kg	0.054
 001 039 100040 00 00	İç Köşe Internal Corner	8	0.606 kg	0.01045
 001 039 100040 01 00	İç Köşe Hareketli Internal Corner Live	8	0.206 kg	0.00939
 001 040 100040 00 00	Dış Köşe External Corner	8	0.743 kg	0.00787
 001 040 100040 01 00	Dış Köşe Hareketli External Corner Live	8	0.599 kg	0.00629
 001 041 100040 00 00	T Köşe T Corner	12	1.150 kg	0.01045
 001 042 100040 00 00	90° L Köşe 90° L Corner	12	1.036 kg	0.01045
 001 043 100060 00 00	Ek Parça Connector	100	0.899 kg	0.01050
 001 044 100060 00 00	Uç Tapa Blind Cap	20	0.228 kg	0.00272
 001 050 030004 00 00	Kilitleme Aparatı Locking Apparatus	-	-	-

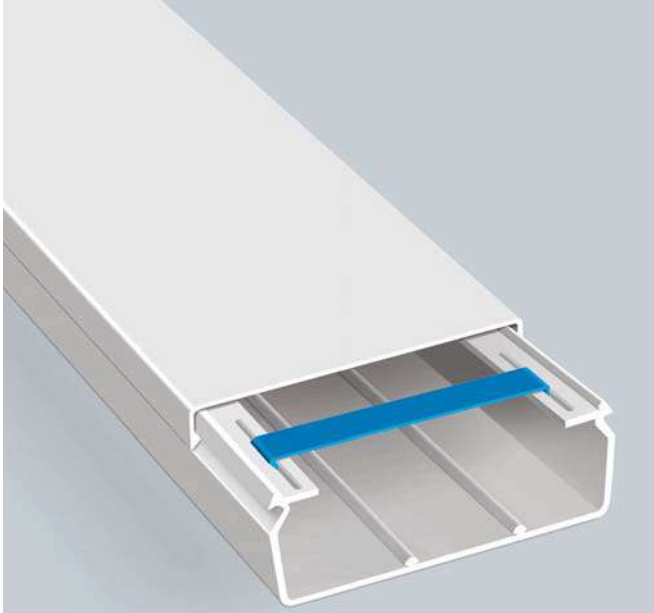

100x48

Kilitleme Aparatlı
With Locking Apparatus

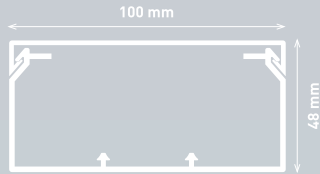

MEKS Serisi Series

Ürün Kodu	Product Code	001 002 100048 20 00
Ambalaj Şekli	Packing Type	Kutu - Box
Adet / m	Quantity / m	24 m
Ağırlık	Weight	25.757 kg
m ³ /	Volume	0.13591

AKSESUARLAR - ACCESSORIES

Kod Code	Ürün Product	Adet Quantity	Ağırlık Weight	m ³ Volume
001 013 100048 00 00	Ara Bölme Partition	150 m	19.61 kg	0.07965
001 039 100048 00 00	İç Köşe Internal Corner	8	0.749 kg	0.01045
001 039 100060 01 00	İç Köşe Hareketli Internal Corner Live	8	0.770 kg	0.01045
001 040 100048 00 00	Dış Köşe External Corner	8	0.808 kg	0.01045
001 040 100060 01 00	Dış Köşe Hareketli External Corner Live	8	0.767 kg	0.01045
001 041 100048 00 00	T Köşe T Corner	8	0.808 kg	0.01045
001 042 100048 00 00	90° L Köşe 90° L Corner	8	0.707 kg	0.01045
001 043 100060 00 00	Ek Parça Connector	100	0.899 kg	0.01050
001 044 100060 00 00	Uç Tapa Blind Cap	20	0.540 kg	0.01045
001 050 030004 00 00	Kilitleme Aparatı Locking Apparatus	-	-	-

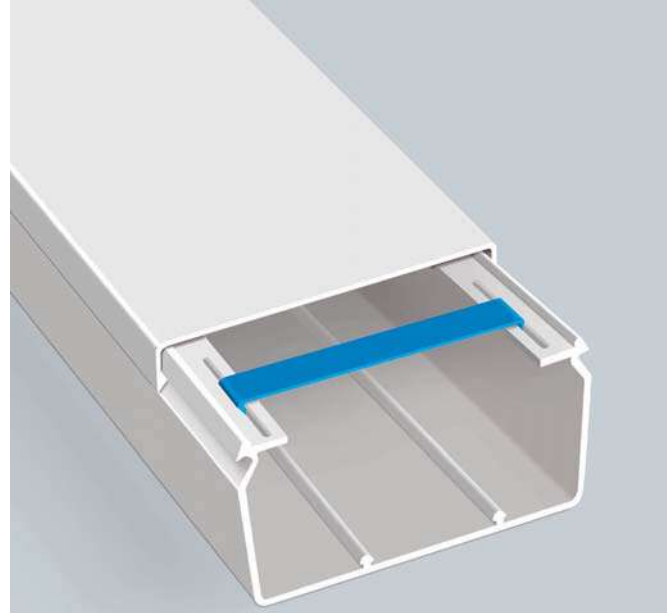

100x60

Kilitleme Aparatlı
With Locking Apparatus

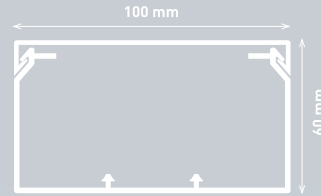

EKO Serisi Series

MEKS Serisi Series

CANALEX Serisi Series

Ürün Kodu	Product Code	001 014 100060 20 00	001 002 100060 20 00	001 156 100060 20 00
Ambalaj Şekli	Packing Type	Kutu - Box	Kutu - Box	Kutu - Box
Adet / m	Quantity / m	20 m	20 m	20 m
Ağırlık	Weight	22.757 kg	22.757 kg	18.557 kg
m ³ /	Volume	0.13590	0.13590	0.13590

AKSESUARLAR - ACCESSORIES

Kod Code	Ürün Product	Adet Quantity	Ağırlık Weight	m ³ Volume
001 013 100060 00 00	Ara Bölme Partition	130 m	19.36 kg	0.07956
001 039 100060 00 00	İç Köşe Internal Corner	8	0.796 kg	0.01045
001 039 100060 01 00	İç Köşe Hareketli Internal Corner Live	8	0.770 kg	0.00939
001 040 100060 00 00	Dış Köşe External Corner	8	0.840 kg	0.01045
001 040 100060 01 00	Dış Köşe Hareketli External Corner Live	10	0.958 kg	0.01045
001 041 100060 00 00	T Köşe T Corner	8	0.890 kg	0.01045
001 042 100060 00 00	90° L Köşe 90° L Corner	8	0.856 kg	0.01045
001 043 100060 00 00	Ek Parça Connector	100	0.899 kg	0.01045
001 044 100060 00 00	Uç Tapa Blind Cap	20	0.228 kg	0.00272
001 050 030004 00 00	Kilitleme Aparatı Locking Apparatus	-	-	-

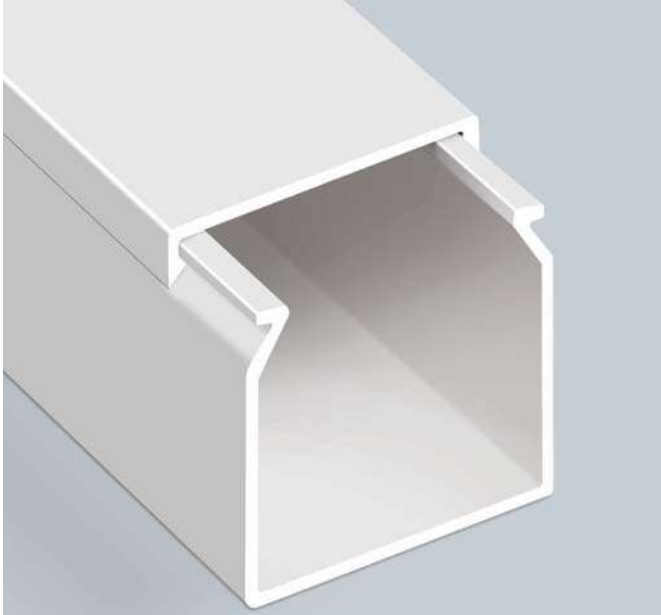
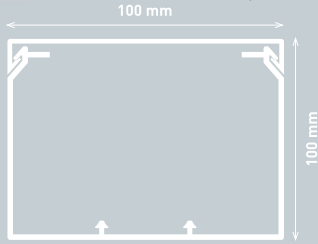
**100x100****Aksesuarsız**
Without Accessories**EKO** Serisi Series

Ürün Kodu	Product Code	001 014 100100 20 00
Ambalaj Şekli	Packing Type	Kutu - Box
Adet / m	Quantity / m	320 m
Ağırlık	Weight	29.157 kg
m ³ /	Volume	0.13590

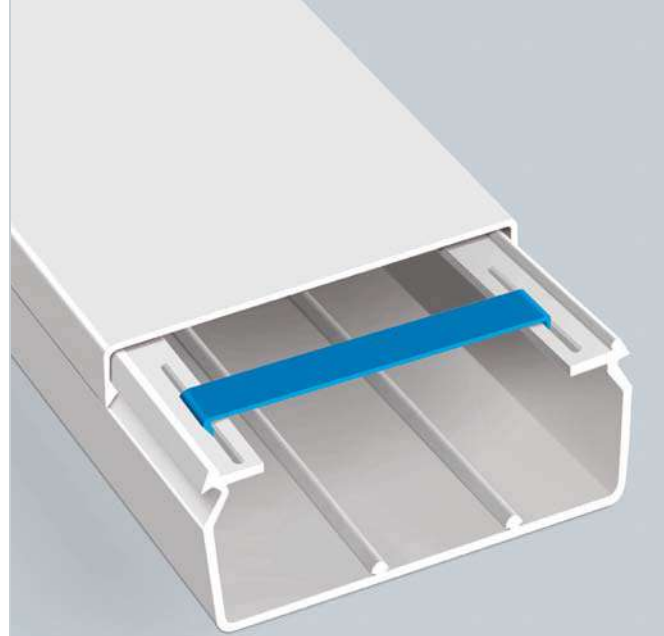
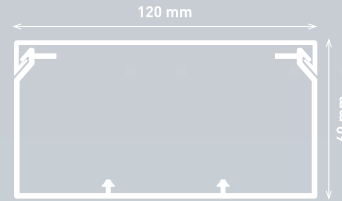
**120x60****Kilitleme Aparatlı**
With Locking Apparatus

Ürün Kodu	Product Code	EKO Serisi Series	MEKS Serisi Series
		001 014 120060 20 00	001 002 120060 20 00
Ambalaj Şekli	Packing Type	Kutu - Box	Kutu - Box
Adet / m	Quantity / m	16 m	16 m
Ağırlık	Weight	23.677 kg	23.677 kg
m ³ /	Volume	0.13590	0.13590

**AKSESUARLAR - ACCESSORIES**

Kod Code	Ürün Product	Adet Quantity	Ağırlık Weight	m ³ Volume
 001 013 120060 20 00	Ara Bölme Partition	130 m	20.010 kg	0.07956
 001 039 120060 00 00	İç Köşe Internal Corner	8	0.749 kg	0.01045
 001 040 120060 00 00	Dış Köşe External Corner	8	0.803 kg	0.01045
 001 041 120060 00 00	T Köşe T Corner	8	0.867 kg	0.01045
 001 042 120060 00 00	90° L Köşe 90° L Corner	8	0.940 kg	0.01045
 001 043 120060 00 00	Ek Parça Connector	50	1.350 kg	0.01045
 001 044 120060 00 00	Uç Tapa Blind Cap	20	0.279 kg	0.00282
 001 050 120060 00 00	Kilitleme Aparatı Locking Apparatus	-	-	-

DIŞTAN KAPAKLI 100'LÜK SERİ PRİZ MONTAJ SETLERİ

External Cover 100 Series Plug Socket Assembly Sets

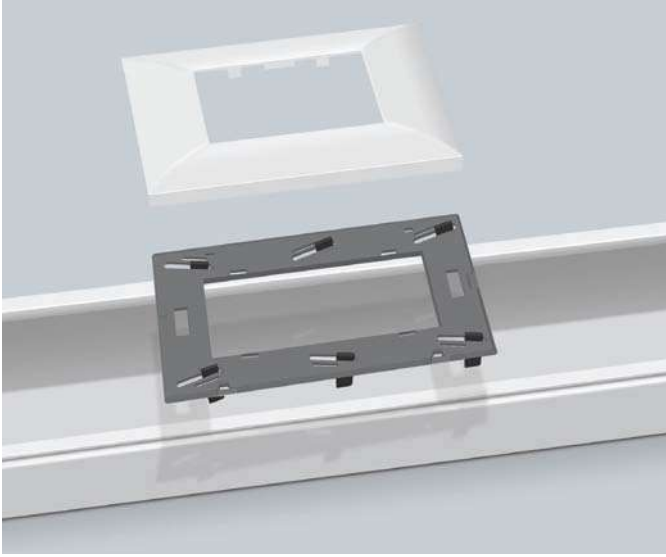

45x45 Tekli Çerçeve Single Frame



Ürün Kodu	Product Code	001 047 040001 00 00
Ambalaj Şekli	Packing Type	Kutu - Box
Adet / m	Quantity / m	20 ad.
Ağırlık	Weight	1.216 kg
m ³ /	Volume	0.00262

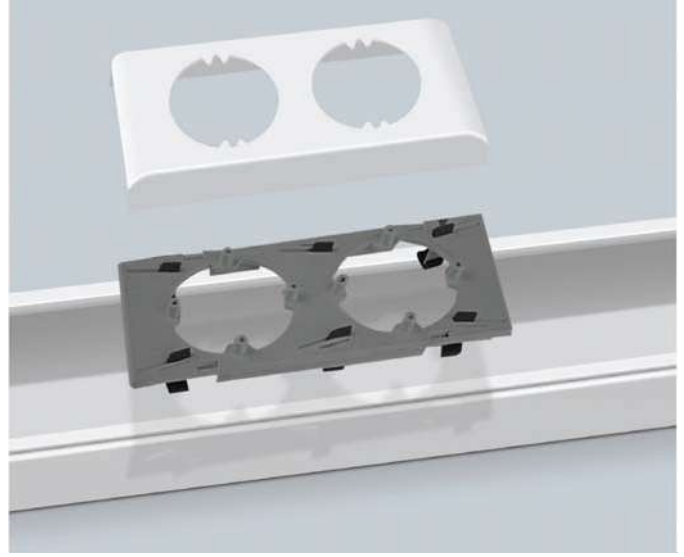

55x55 Tekli Çerçeve Single Frame



Ürün Kodu	Product Code	001 047 020001 00 00
Ambalaj Şekli	Packing Type	Kutu - Box
Adet / m	Quantity / m	20 ad.
Ağırlık	Weight	1.216 kg
m ³ /	Volume	0.00262

45x45 İkili Çerçeve Double Frame



Ürün Kodu	Product Code	001 047 040002 00 00
Ambalaj Şekli	Packing Type	Kutu - Box
Adet / m	Quantity / m	14 ad.
Ağırlık	Weight	1.143 kg
m ³ /	Volume	0.00536

55x55 İkili Çerçeve Double Frame



Ürün Kodu	Product Code	001 047 020002 00 00
Ambalaj Şekli	Packing Type	Kutu - Box
Adet / m	Quantity / m	14 ad.
Ağırlık	Weight	1.143 kg
m ³ /	Volume	0.00536

45x45 Üçlü Çerçeve Triple Frame



Ürün Kodu	Product Code	001 047 040003 00 00
Ambalaj Şekli	Packing Type	Kutu - Box
Adet / m	Quantity / m	14 ad.
Ağırlık	Weight	1.417 kg
m ³ /	Volume	0.00793

55x55 Üçlü Çerçeve Triple Frame



Ürün Kodu	Product Code	001 047 020003 00 00
Ambalaj Şekli	Packing Type	Kutu - Box
Adet / m	Quantity / m	14 ad.
Ağırlık	Weight	1.417 kg
m ³ /	Volume	0.00793

45x45 Dörtlü Çerçeve Quartet Frame



Ürün Kodu	Product Code	001 047 040004 00 00
Ambalaj Şekli	Packing Type	Kutu - Box
Adet / m	Quantity / m	10 ad.
Ağırlık	Weight	1.21 kg
m ³ /	Volume	0.01104



45x22.5 Data Priz Kapağı

45x22.5 Data Socket Frame

888 049 050012



Data Konnektörü 1x8 CAT6

Data Connector 1x8 CAT 6

888 049 050032



Kanal Kilitleme Aparatı

It prevents stretching which could occur in time

001 050 030004 00 00

Kanalda zamanla oluşabilecek esnemelerin önüne geçer.

Prevents back last that could occur in the trunking.

İNGİLİZ NORMU PRİZ MONTAJ SETLERİ

BRITISH NORM PLUG SOCKET ASSEMBLY SETS



İngiliz Normu Tekli Priz Tabanı

British Norm Single Socket Base

Ürün Kodu	Product Code	001 047 980001 0000
Ambalaj Şekli	Packing Type	Kutu - Box
Adet / m	Quantity / m	200
Ağırlık	Weight	3.85 kg
m ³ /	Volume	0.04



İngiliz Normu İkili Priz Tabanı

British Norm Double Socket Base

Ürün Kodu	Product Code	001 047 980002 0000
Ambalaj Şekli	Packing Type	Kutu - Box
Adet / m	Quantity / m	100
Ağırlık	Weight	2.475 kg
m ³ /	Volume	0.037

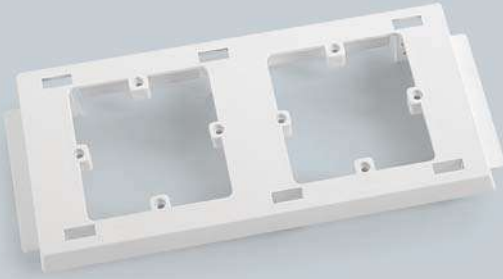

İngiliz Normu İkili Yüksek Tip Priz Tabanı

British Norm Double High Type Socket Base

Ürün Kodu	Product Code	001 047 990002 00 00
Ambalaj Şekli	Packing Type	Kutu - Box
Adet / m	Quantity / m	94
Ağırlık	Weight	5.076 kg
m ³ /	Volume	0.0017



Sıvaaltı Anahtar Kasası (Kare Buat)

Flush Mounted Switch Casing (Square Junction Box)

Ürün Kodu	Product Code	001 166 000001 00 00
Ambalaj Şekli	Packing Type	Kutu - Box
Adet / m	Quantity / m	28
Ağırlık	Weight	1.18 kg
m ³ /	Volume	0.011

Meksplus serisi içten kapaklı kanallar

Meksplus Series
Internal Cover
Cable Trunking

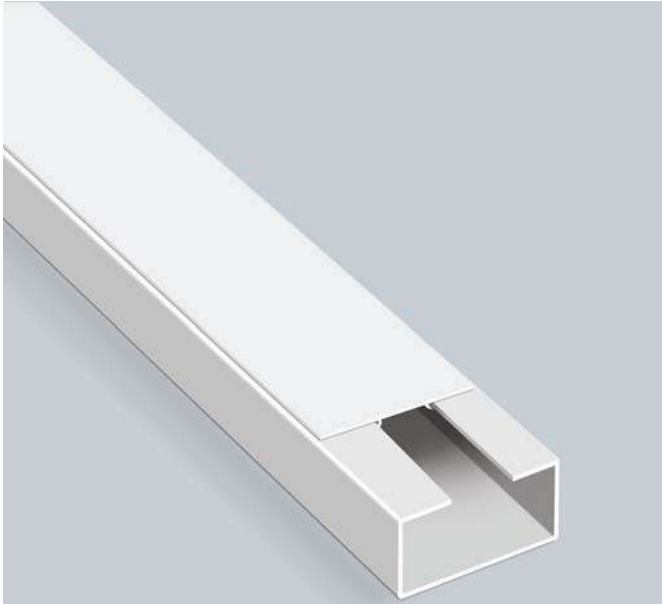
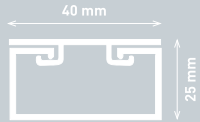

İçten Kapaklı
Intrinsic Cover

**40x25****Aksesuarsız**
Without Accessories**MEKPLUS** Serisi Series

Ürün Kodu	Product Code	001 003 040025 20 00
Ambalaj Şekli	Packing Type	Kutu - Box
Adet / m	Quantity / m	80 m
Ağırlık	Weight	26.843 kg
m ³ /	Volume	0.09592

**Koruma Bantlı**
Protecting Foil**100x37****EKO** Serisi - Series**MEKS** Serisi - Series**MEKPLUS** Serisi - Series

Ürün Kodu	Product Code	001 014 100037 20 00	001 002 100037 20 00	001 003 100037 20 00
Ambalaj Şekli	Packing Type	Kutu - Box	Kutu - Box	Kutu - Box
Adet / m	Quantity / m	30 m	30 m	30 m
Ağırlık	Weight	29.067 kg	29.067 kg	29.067 kg
m ³ /	Volume	0.12546	0.12546	0.12546

AKSESUARLAR - ACCESSORIES

	Kod Code	Ürün Product	Adet Quantity	Ağırlık Weight	m ³ Volume
	001 013 100037 00 00	Ara Bölme Partition	200 m	19.65 kg	0.054
	001 039 100037 00 00	İç Köşe Internal Corner	12	0.927 kg	0.00984
	001 039 100050 01 00	İç Köşe Hareketli Internal Corner Live	12	0.696 kg	0.00984
	001 040 100037 00 00	Dış Köşe External Corner	8	0.570 kg	0.00984
	001 040 100050 01 00	Dış Köşe Hareketli External Corner Live	10	0.895 kg	0.01011
	001 041 100037 00 00	T Köşe T Corner	12	0.990 kg	0.01011
	001 042 100037 00 00	90° L Köşe 90° L Corner	12	0.856 kg	0.00984
	001 043 100050 00 00	Ek Parça Connector	100	1.5 kg	0.01050
	001 044 100037 00 00	Uç Tapa Blind Cap	50	0.702 kg	0.00272





Koruma Bantlı
Protecting Foil

100x41



		MEKS Serisi - Series	MEKSPLUS Serisi - Series
Ürün Kodu	Product Code	001 002 100041 20 00	001 003 100041 20 00
Ambalaj Şekli	Packing Type	Kutu - Box	Kutu - Box
Adet / m	Quantity / m	324 m	324 m
Ağırlık	Weight	21.918 kg	21.918 kg
m ³ /	Volume	0,12221	0,12221

AKSESUARLAR - ACCESSORIES

	Kod Code	Ürün Product	Adet Quantity	Ağırlık Weight	m ³ Volume
	001 013 100040 20 00	Ara Bölme Partition	200 m	21.05 kg	0,054
	001 039 100050 00 00	İç Köşe Internal Corner	8	0,443 kg	0,00984
	001 039 100050 01 00	İç Köşe Hareketli Internal Corner Live	12	0,847 kg	0,00984
	001 040 100050 00 00	Dış Köşe External Corner	8	0,722 kg	0,00984
	001 040 100050 01 00	Dış Köşe Hareketli External Corner Live	10	0,895 kg	0,01011
	001 041 100050 00 00	T Köşe T Corner	8	0,647 kg	0,00984
	001 042 100050 00 00	90° L Köşe 90° L Corner	8	0,611 kg	0,00984
	001 043 100050 00 00	Ek Parça Connector	100	1,394 kg	0,01011
	001 044 100050 00 00	Uç Tapa Blind Cap	40	0,711 kg	0,00984

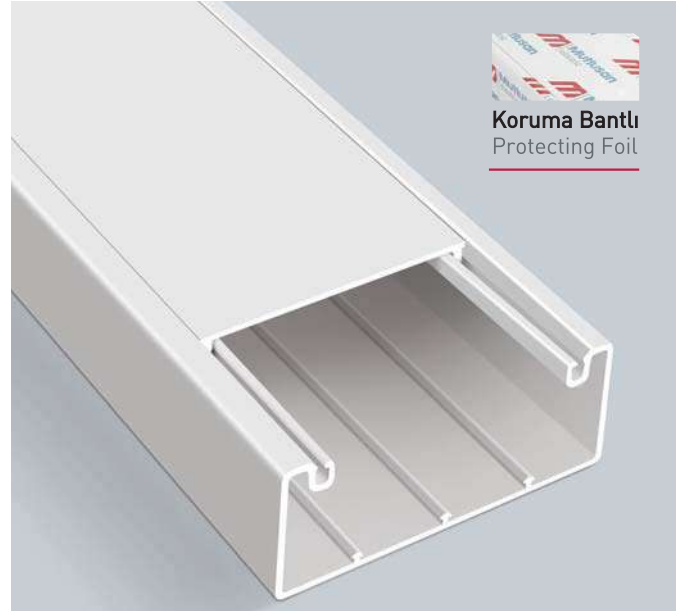

Koruma Bantlı
Protecting Foil

100x50



Kanal içi Küp Buat
Duct Junction Cube

		CANALEX Serisi - Series	EKO Serisi - Series	MEKS Serisi - Series	MEKSPLUS Serisi - Series
Ürün Kodu	Product Code	001 156 100050 20 00	001 014 100050 20 00	001 002 100050 20 00	001 003 100050 20 00
Ambalaj Şekli	Packing Type	Kutu Box	Kutu Box	Kutu Box	Kutu Box
Adet / m	Quantity / m	20 m	20 m	20 m	20 m
Ağırlık	Weight	17,79 kg	19,37 kg	21,46 kg	22,31 kg
m ³ /	Volume	0,127	0,127	0,127	0,127

AKSESUARLAR - ACCESSORIES

	Kod Code	Ürün Product	Adet Quantity	Ağırlık Weight	m ³ Volume
	001 013 100048 20 00	Ara Bölme Partition	150 m	19,61 kg	0,075
	001 039 100050 00 00	İç Köşe Internal Corner	8	0,443 kg	0,00984
	001 039 100050 01 00	İç Köşe Hareketli Internal Corner Live	12	0,847 kg	0,00984
	001 040 100050 00 00	Dış Köşe External Corner	8	0,722 kg	0,00984
	001 040 100050 01 00	Dış Köşe Hareketli External Corner Live	10	0,895 kg	0,01011
	001 041 100050 00 00	T Köşe T Corner	8	0,647 kg	0,00984
	001 042 100050 00 00	90° L Köşe 90° L Corner	8	0,611 kg	0,00984
	001 043 100050 00 00	Ek Parça Connector	100	1,394 kg	0,01011
	001 044 100050 00 00	Uç Tapa Blind Cap	40	0,711 kg	0,00984
	001 043 100050 01 00	Ek parça (3'lü Set) Connector (3 set)	100	1,430 kg	0,00987
	001 046 195100 00 00	Kanal içi Küp Buat Duct Junction Cube	25	1,180 kg	0,0086



Koruma Bantlı
Protecting Foil

100x50

Kaidesiz
Compatible With Mounting
Without Base

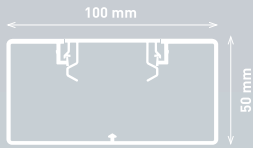

MEKPLUS Serisi Series

Ürün Kodu	Product Code	001 006 100050 20 00
Ambalaj Şekli	Packing Type	Kutu - Box
Adet / m	Quantity / m	20 m
Ağırlık	Weight	22.17 kg
m ³ /	Volume	0.120

AKSESUARLAR - ACCESSORIES

Kod Code	Ürün Product	Adet Quantity	Ağırlık Weight	m ³ Volume
 001 013 100048 20 00	Ara Bölme Partition	150 m	19.61 kg	0.075
 001 039 100051 00 00	İç Köşe Internal Corner	8	0.443 kg	0.00984
 001 040 100051 00 00	Dış Köşe External Corner	8	0.722 kg	0.00984
 001 041 100051 00 00	T Köşe T Corner	8	0.647 kg	0.01011
 001 042 100051 00 00	90° L Köşe 90° L Corner	8	0.611 kg	0.00984
 001 043 100051 00 00	Ek Parça Connector	100	1.394 kg	0.01011
 001 044 100051 00 00	Uç Tapa Blind Cap	40	0.711 kg	0.00984
 001 888 100050 00 00	Kilitleme Aparatı Locking Apparatus	50	-	-

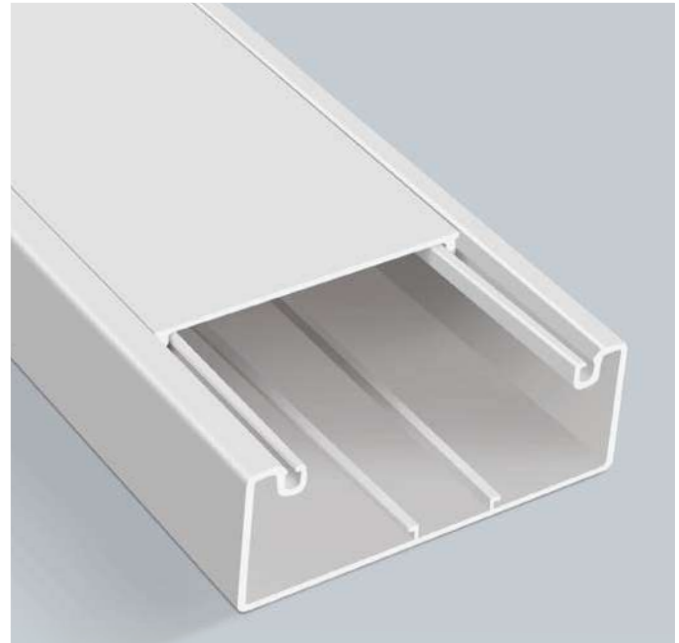

120x70

Aksesuarsız
Without Accessories



MEKPLUS Serisi Series

Ürün Kodu	Product Code	001 003 120070 20 00
Ambalaj Şekli	Packing Type	Kutu - Box
Adet / m	Quantity / m	16 m
Ağırlık	Weight	25.673 kg
m ³ /	Volume	0.18189

AKSESUARLAR - ACCESSORIES

Kod Code	Ürün Product	Adet Quantity	Ağırlık Weight	m ³ Volume
 001 013 120070 20 00	Ara Bölme Partition	60 m	10.16 kg	0.080

100x50

Kaidesiz
Compatible With Mounting
Without Base





Koruma Bantlı
Protecting Foil



170x50



MEKSPLUS Serisi Series

Ürün Kodu	Product Code	001 003 170050 20 00
Ambalaj Şekli	Packing Type	Kutu - Box
Adet / m	Quantity / m	12 m
Ağırlık	Weight	19.23 kg
m ³ /	Volume	0.174

AKSESUARLAR - ACCESSORIES

Kod Code	Ürün Product	Adet Quantity	Ağırlık Weight	m ³ Volume
 001 013 170070 20 00	Ara Bölme Partition	60 m	10.16 kg	0.080
 001 039 170050 00 00	İç Köşe Internal Corner	40	0.343 kg	0.00292
 001 040 170050 00 00	Dış Köşe External Corner	40	0.448 kg	0.00260
 001 041 170050 00 00	T Köşe T Corner	30	0.327 kg	0.00260
 001 042 170050 00 00	90° L Köşe 90° L Corner	50	0.448 kg	0.00260
 001 043 170050 00 00	Ek Parça Connector	100	0.126 kg	0.00260
 001 044 170050 00 00	Uç Tapa Blind Cap	100	0.263 kg	0.00260



170x70

Aksesuarsız
Without Accessories

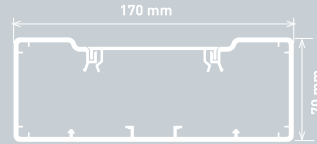

MEKSPLUS Serisi Series

Ürün Kodu	Product Code	001 003 170070 20 00
Ambalaj Şekli	Packing Type	Kutu - Box
Adet / m	Quantity / m	12 m
Ağırlık	Weight	29.23 kg
m ³ /	Volume	0.174

AKSESUARLAR - ACCESSORIES

Kod Code	Ürün Product	Adet Quantity	Ağırlık Weight	m ³ Volume
 001 013 170070 20 00	Ara Bölme Partition	60 m	10.16 kg	0.080

**250x70****Aksesuarsız**
Without Accessories**MEKPLUS** Serisi
Series

Ürün Kodu	Product Code	001 003 250070 20 00
Ambalaj Şekli	Packing Type	Kutu - Box
Adet / m	Quantity / m	8 m
Ağırlık	Weight	24.073 kg
m ³ /	Volume	0.17357

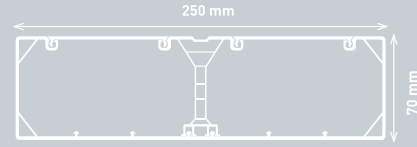
Priz Montaj Setsiz
Without Plug Socket Assembly Set**250x70****Bölmeli - Partitioned**
Aksesuarsız - Without Accessories**MEKPLUS** Serisi
Series

Ürün Kodu	Product Code	001 003 250970 20 00
Ambalaj Şekli	Packing Type	Kutu - Box
Adet / m	Quantity / m	8 m
Ağırlık	Weight	28.713 kg
m ³ /	Volume	0.17357

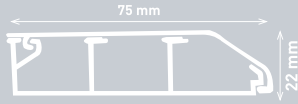

75x22

MEKS Serisi Series

Ürün Kodu	Product Code	001 002 075022 20 00
Ambalaj Şekli	Packing Type	Kutu - Box
Adet / m	Quantity / m	50 m
Ağırlık	Weight	33.743 kg
m ³ /	Volume	0.09685

AKSESUARLAR - ACCESSORIES

Kod Code	Ürün Product	Adet Quantity	Ağırlık Weight	m ³ Volume
001 039 075022 00 00	İç Köşe Internal Corner	1	0.015 kg.	0.00009
001 040 075022 00 00	Dış Köşe External Corner	1	0.016 kg.	0.00008
001 043 075022 00 00	Ek Parça Connector	1	0.004 kg.	0.00003
001 044 075022 01 00	Sağ Uç Tapa Blind Cap Right	1	0.004 kg.	0.00003
001 044 075022 02 00	Sol Uç Tapa Blind Cap Left	1	0.004 kg.	0.00003

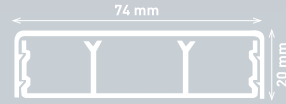

74x20

Tam Kapaklı Bölmeli
Full Cover And Partitioned

EKO Serisi Series

MEKS Serisi Series

Ürün Kodu	Product Code	001 014 974020 20 00	001 002 974020 20 00
Ambalaj Şekli	Packing Type	Kutu - Box	Kutu - Box
Adet / m	Quantity / m	50 m	50 m
Ağırlık	Weight	27.493 kg	27.493 kg
m ³ /	Volume	0.0938	0.0938

AKSESUARLAR - ACCESSORIES

Kod Code	Ürün Product	Adet Quantity	Ağırlık Weight	m ³ Volume
001 039 074020 00 00	İç Köşe Internal Corner	20	0.250 kg	0.00262
001 040 074020 00 00	Dış Köşe External Corner	20	0.299 kg	0.00730
001 041 074020 00 00	T Köşe T Corner	30	1.182 kg	0.00730
001 042 074020 01 00	90° L Köşe 90° L Corner	40	1.260 kg	0.00730
001 043 074020 00 00	Ek Parça Connector	50	0.350 kg	0.00730
001 044 074020 00 00	Uç Tapa Blind Cap	50	0.505 kg	0.00730
001 047 0117420 00 00	P. M Kasası Socket Assembly Frame	6	0.574 kg	-
001 047 017421 00 00	P. M Kasası 1'li Socket Assembly Frame Single	12	1.161 kg	0.00731
001 043 017422 00 00	P. M Kasası 2'li Socket Assembly Frame Double	-	-	-
001 043 017423 00 00	P. M Kasası 3'lü Socket Assembly Frame Triple	-	-	-

İÇTEN KAPAKLI PRİZ MONTAJ SETLERİ

Socket Assembly Adaptor for Internal Cover Trunkings

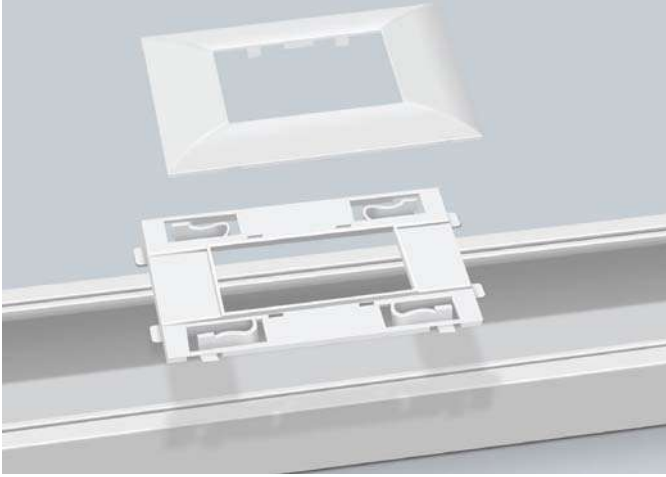

45x45 Tekli Çerçeve Single Frame



Ürün Kodu	Product Code	001 047 070001 00 00
Ambalaj Şekli	Packing Type	Kutu - Box
Adet / m	Quantity / m	20 ad.
Ağırlık	Weight	0.99 kg
m ³ /	Volume	0.00566

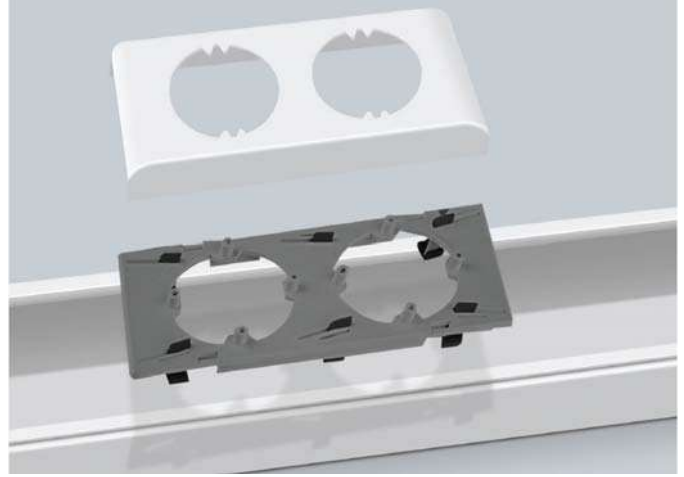

55x55 Tekli Çerçeve Single Frame



Ürün Kodu	Product Code	001 047 080001 00 00
Ambalaj Şekli	Packing Type	Kutu - Box
Adet / m	Quantity / m	20 ad.
Ağırlık	Weight	1.145 kg
m ³ /	Volume	0.0063

45x45 İkili Çerçeve Double Frame



Ürün Kodu	Product Code	001 047 070002 00 00
Ambalaj Şekli	Packing Type	Kutu - Box
Adet / m	Quantity / m	14 ad.
Ağırlık	Weight	0.923 kg
m ³ /	Volume	0.00566

55x55 İkili Çerçeve Double Frame



Ürün Kodu	Product Code	001 047 080002 00 00
Ambalaj Şekli	Packing Type	Kutu - Box
Adet / m	Quantity / m	14 ad.
Ağırlık	Weight	1.12 kg
m ³ /	Volume	0.0063

45x45 Üçlü Çerçeve Triple Frame



Ürün Kodu	Product Code	001 047 070003 00 00
Ambalaj Şekli	Packing Type	Kutu - Box
Adet / m	Quantity / m	12 ad.
Ağırlık	Weight	0.947 kg
m ³ /	Volume	0.0068

55x55 Üçlü Çerçeve Triple Frame



Ürün Kodu	Product Code	001 047 080003 00 00
Ambalaj Şekli	Packing Type	Kutu - Box
Adet / m	Quantity / m	10 ad.
Ağırlık	Weight	1.113 kg
m ³ /	Volume	0.0063

45x45 Dörtlü Çerçeve Quartet Frame

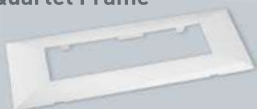

Ürün Kodu	Product Code	001 047 070004 00 00
Ambalaj Şekli	Packing Type	Kutu - Box
Adet / m	Quantity / m	10 ad.
Ağırlık	Weight	1.18 kg
m ³ /	Volume	0.0062



**45x22.5 Data
Priz Kapağı**
**45x22.5 Data
Socket Frame**
888 049 050012



**Data Konnektörü
1x8 CAT6**
**Data Connector
1x8 CAT 6**
888 049 050032



**Kanal Kilitleme
Aparatı**
It prevents
stretching which
could occur in time

001 050 030004 00 00
Kanalda zamanla
oluşabilecek
esnemelerin önüne
geçer.
Prevents back last that
could occur in the
trunking.

001 052 300001 00 00
45x45 Topraklı
Priz Çekirdekleri 45°
45x45 Earthed Socket Cores 45°



001 052 300002 00 00
45x45 UPS
Priz Çekirdekleri 45°
45x45 UPS Socket Cores 45°



001 052 200005 00 00
45x45 UPS ve Topraklı
Priz Birleştirme Aparatı
45 x 45 UPS and earthed socket
connection apparatus



888 049 050013
45x45 Data Priz Kapağı
45x45 Data Socket Cover





001 050 030003 00 00
100x37/50
Kanal Kilitleme Aparatı
Trunking Locking Apparatusı

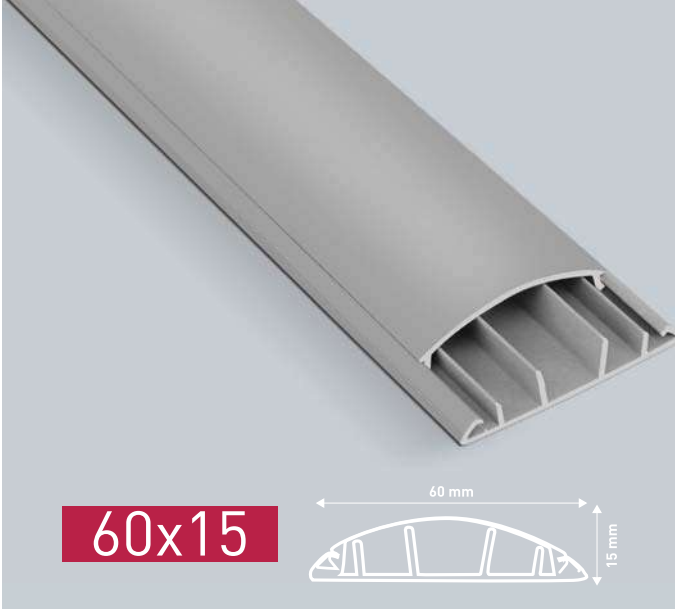



Ürün Kodu	Product Code	001 002 060015 20 17
Ambalaj Şekli	Packing Type	Kutu - Box
Adet / m	Quantity / m	40 m
Ağırlık	Weight	18,4 kg
m ³ /	Volume	0,0435



AKSESUARLAR - ACCESSORIES

Kod Code	Ürün Product	Adet Quantity	Ağırlık Weight	m ³ Volume
 001 041 060015 00 17	T Köşe T Corner	10	0.414 kg	0.00234
 001 042 060015 00 17	L Köşe L Corner	24	0.429 kg	0.00272
 001 043 060015 00 17	Ek Parça Connector	50	0.187 kg	0.00130
 001 044 060015 00 17	Uç Tapa Blind Cap	50	0.197 kg	0.00130



Ürün Kodu	Product Code	001 002 075018 20 17
Ambalaj Şekli	Packing Type	Kutu - Box
Adet / m	Quantity / m	30 m
Ağırlık	Weight	37,76 kg
m ³ /	Volume	0,0828





AKSESUARLAR - ACCESSORIES

Kod Code	Ürün Product	Adet Quantity	Ağırlık Weight	m ³ Volume
 001 041 075018 00 17	T Köşe T Corner	8	0.454 kg	0.00279
 001 042 075018 00 17	L Köşe L Corner	20	0.524 kg	0.00279
 001 043 075018 00 17	Ek Parça Connector	50	0.200 kg	0.00131
 001 044 075018 00 17	Uç Tapa Blind Cap	50	0.273 kg	0.00134



Ürün Kodu	Product Code	001 002 090020 20 17
Ambalaj Şekli	Packing Type	Kutu - Box
Adet / m	Quantity / m	20 m
Ağırlık	Weight	33,16 kg
m ³ /	Volume	0,07956

AKSESUARLAR - ACCESSORIES

Kod Code	Ürün Product	Adet Quantity	Ağırlık Weight	m ³ Volume
 001 041 090020 00 17	T Köşe T Corner	10	0.851 kg	0.00842
 001 042 090020 00 17	L Köşe L Corner	20	0.778 kg	0.00653
 001 043 090020 00 17	Ek Parça Connector	50	0.215 kg	0.00134
 001 044 090020 00 17	Uç Tapa Blind Cap	50	0.275 kg	0.00134



H Profil 8

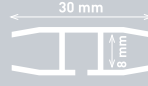

Ürün Kodu	Product Code	001 015 008000 20 00
Ambalaj Şekli	Packing Type	Kutu - Box
Adet / m	Quantity / m	100 m
Ağırlık	Weight	16.5 kg
m ³ /	Volume	0.03121

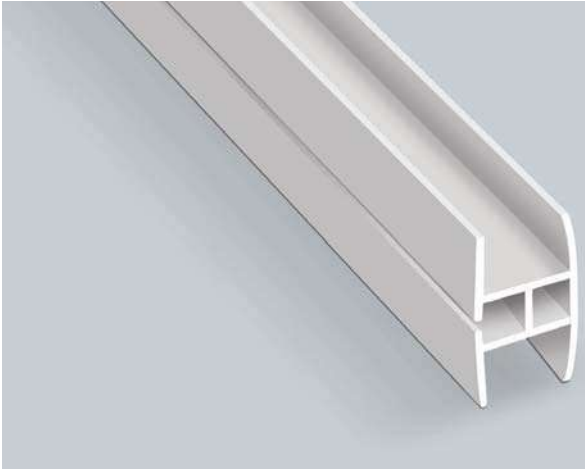

H Profil 10

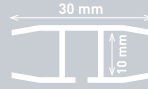

Ürün Kodu	Product Code	001 015 010000 20 00
Ambalaj Şekli	Packing Type	Kutu - Box
Adet / m	Quantity / m	100 m
Ağırlık	Weight	18 kg
m ³ /	Volume	0.03745

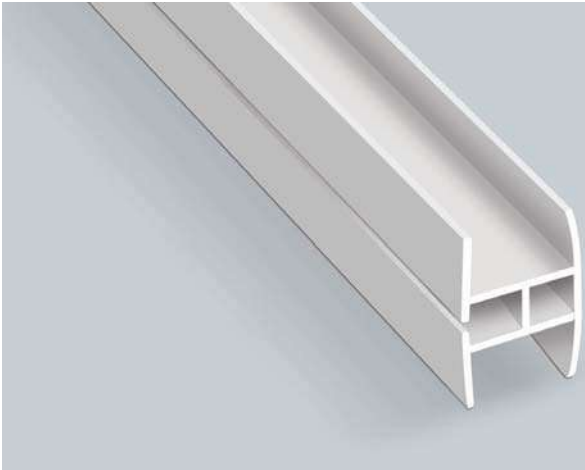

H Profil 12



Ürün Kodu	Product Code	001 015 012000 20 00
Ambalaj Şekli	Packing Type	Kutu - Box
Adet / m	Quantity / m	100 m
Ağırlık	Weight	19.5 kg
m ³ /	Volume	0.04369



9.5x7



Şeffaf Mini Kanal
(Kapaksız - Yapışkanlı)
Transparent Mini Trunking
(Without Cover - With Adhesive)

Ürün Kodu	Product Code	001 004 010007 20 44
Ambalaj Şekli	Packing Type	Kutu - Box
Adet / m	Quantity / m	500 m
Ağırlık	Weight	16.45 kg
m ³ /	Volume	0.0435

Klima Kanalı

Air Conditioning
Trunking



Dış Uç Tapa
External Blind Cap

Ek Parça
Connector

İç Köşe
Internal Corner

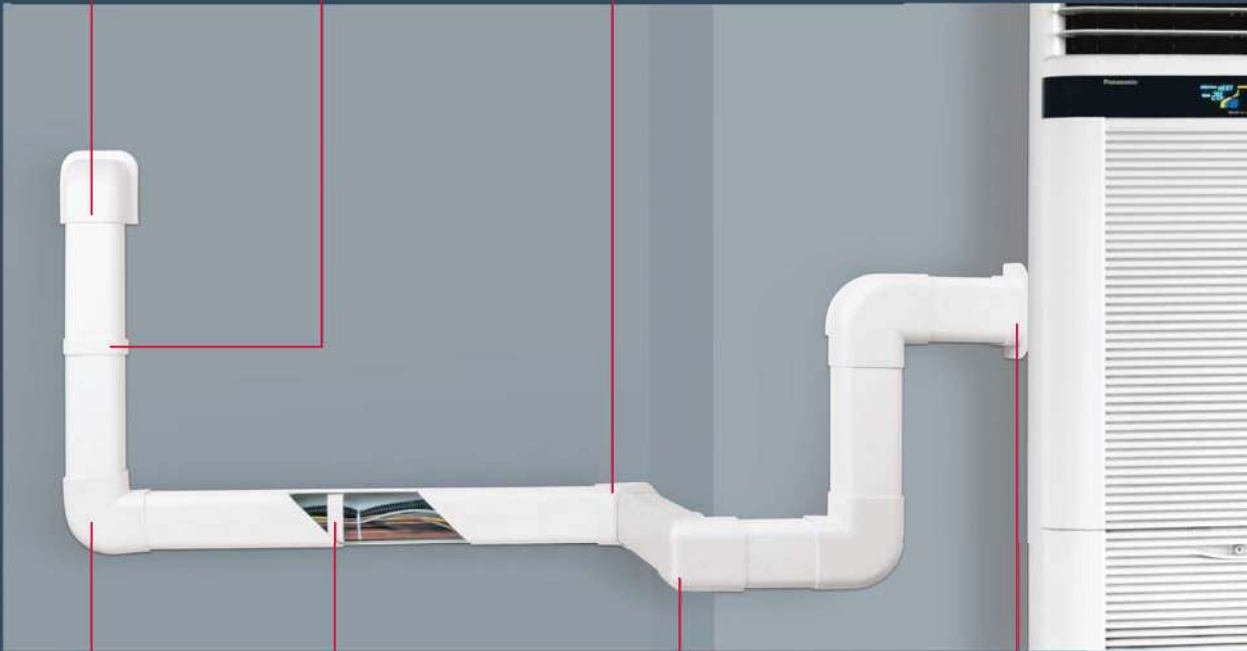

90° L Köşe
90° L Corner

Kablo Tutucu
Cable Holder

Dış Köşe
External Corner

Duvar Geçisi
Wall Penetration



75x60

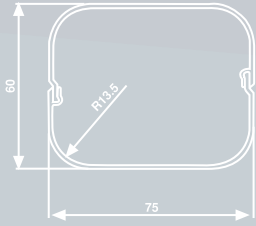

MEKS Serisi Series

Ürün Kodu	Product Code	001 002 075060 20 00
Ambalaj Şekli	Packing Type	Kutu - Box
Adet / m	Quantity / m	30 m
Ağırlık	Weight	19.543 kg
m ³ /	Volume	0.09663

AKSESUARLAR - ACCESSORIES

Kod Code	Ürün Product	Adet Quantity	Ağırlık Weight	m ³ Volume
 001 039 075060 00 00	İç Köşe Internal Corner	24	2.485 kg	0.00732
 001 040 075060 00 00	Dış Köşe External Corner	24	0.897 kg	0.00984
 001 042 075060 00 00	90° L Köşe 90° L Corner	18	1.040 kg	0.00984
 001 043 075060 00 00	Ek Parça Connector	40	0.440 kg	0.00280
 001 044 075060 01 00	İç Uç Tapa Internal Blind Cap	30	0.870 kg	0.01045
 001 044 075060 02 00	Dış Uç Tapa External Blind Cap	18	0.684 kg	0.01045
 001 050 030001 00 00	Duvar Geçişli Wall Penetration	-	-	-
 001 050 030002 00 00	Kablo Tutucu Cable Holder	-	-	-



Sidem serisi kablo kanalları

Sidem series
cable trunking

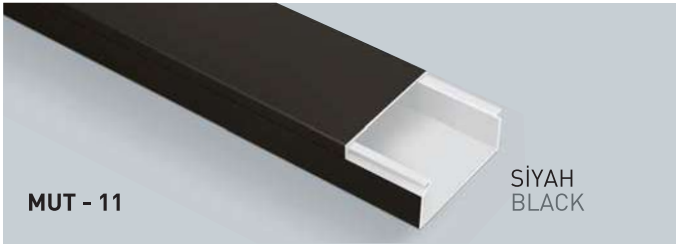

RENK SEÇENEKLERİ COLOR OPTIONS**AHŞAP RENK SEÇENEKLERİ** WOOD COLOR OPTIONS**AKSESUARLAR** ACCESSORIES

**Delikli kablo
kanallarımızın
Teknik Özellikleri**
Technical specifications
for perforated cable
trunkings



Ultraviyole ışınlarına
karşı dayanıklıdır.
Resistance to UV light.



Asit buharına
dayanıklıdır.
Resistance to acidic
vapor.

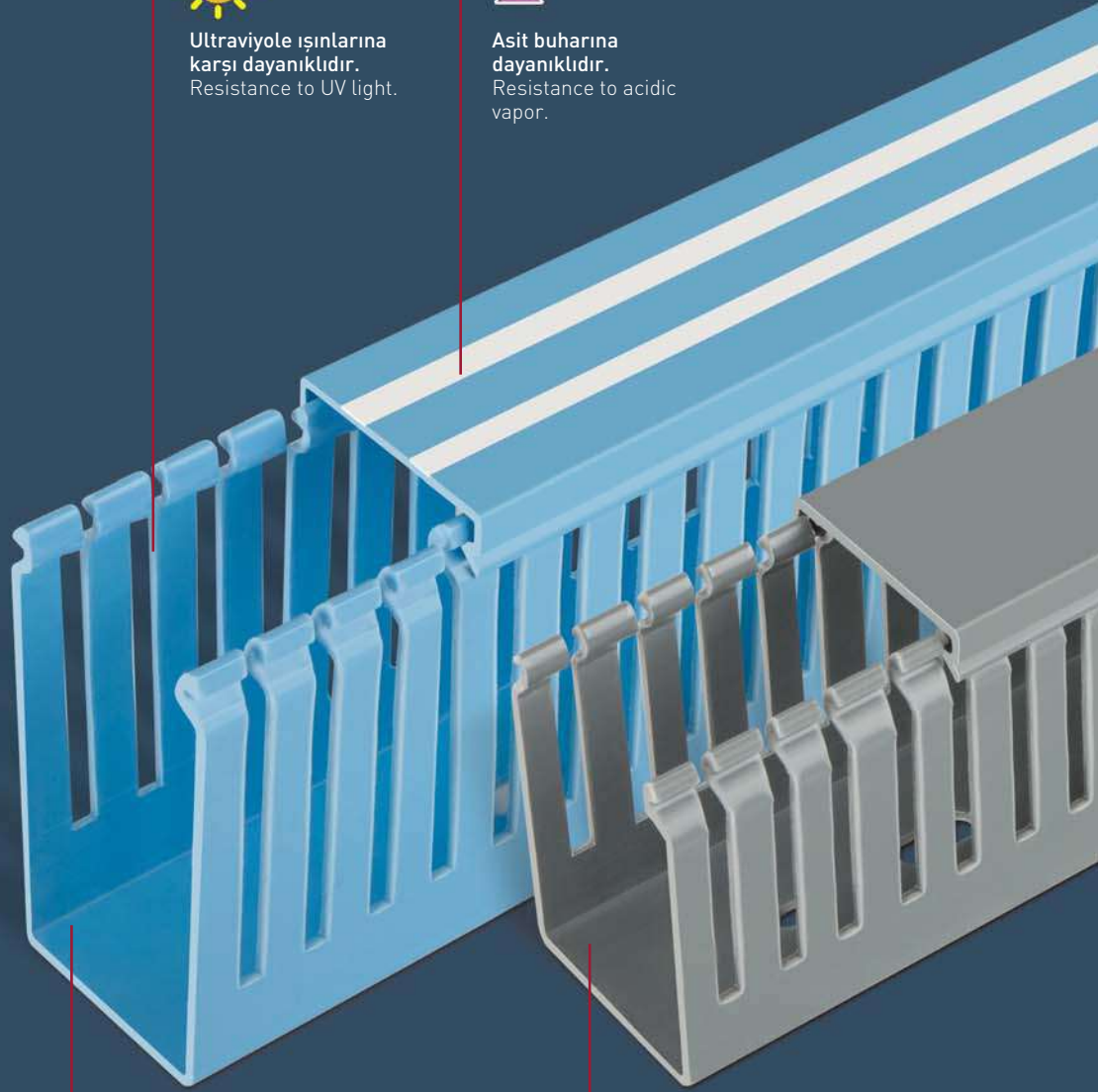

Tüm kanallarımız çift
tarafli yapışkanlı bant
ile kullanılabilir.
Adhesive models are
easy to install.



Aşırı soğuğa ve sicağa
karşı dayanıklı.
Resistant to extreme
cold and heat.

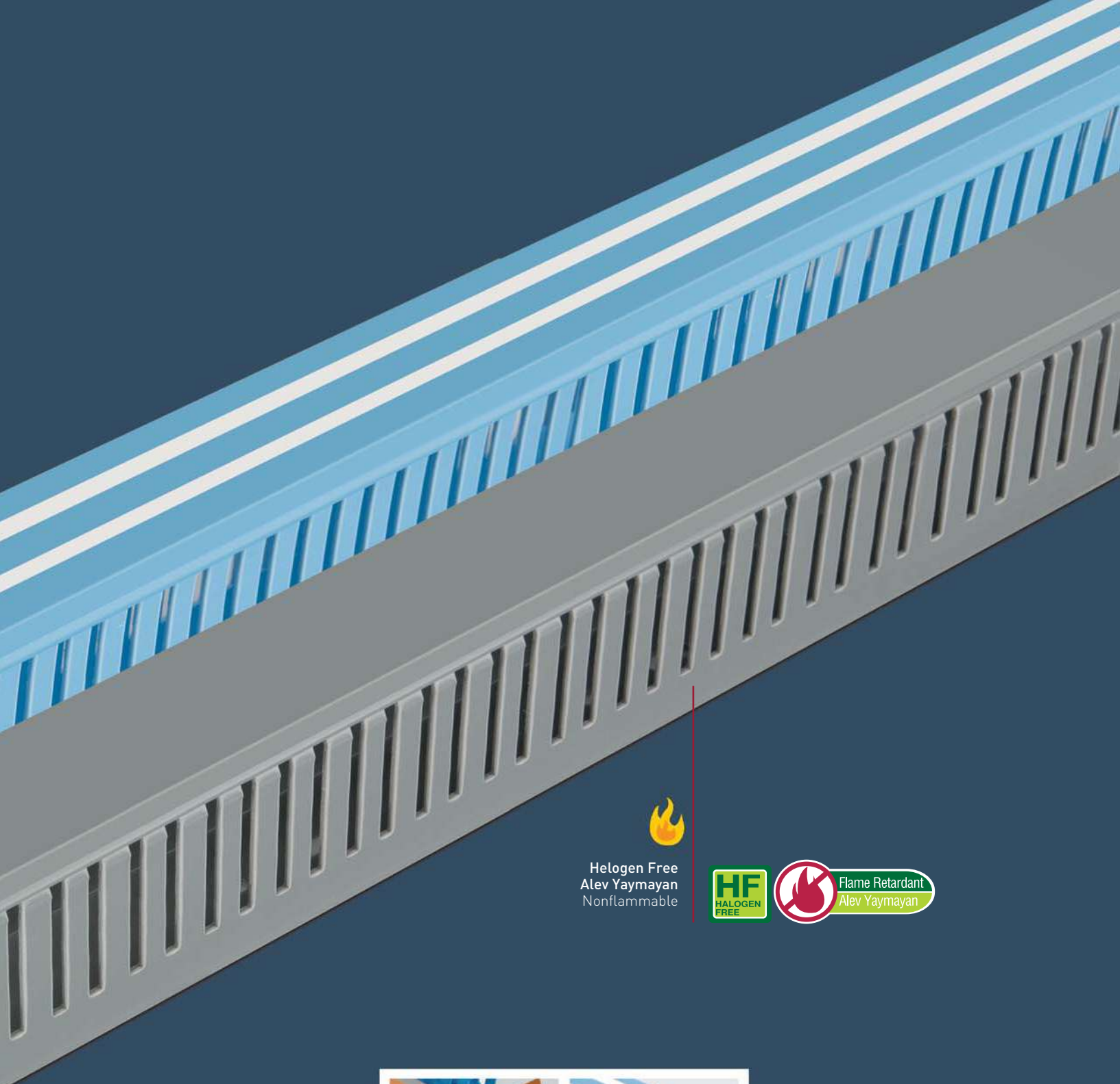

Helogen Free
Alev Yaymayan
Nonflammable



Flame Retardant
Alev Yaymayan

Kolay yapışmayı sağlayan,
Çift taraflı bant kullanılabilir.

Double sided adhesive
Tape assuring easy fixation
Can be used



Yazı yazmayı kolaylaştıran
beyaz bant

Easy-to-write
white strips

Kablo çıkışları için
belirli aralıklar

Regular intervals for
cable outlets

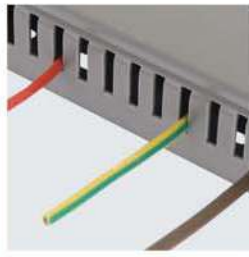

Düzenli aralıklarla
montaj delikleri

Assembly holes with
regular intervals

HALOGEN FREE DELİKLİ KABLO KANALI

HALOGEN FREE PERFORATED CABLE TRUNKING



Flame Retardant
Alev Yaymayan

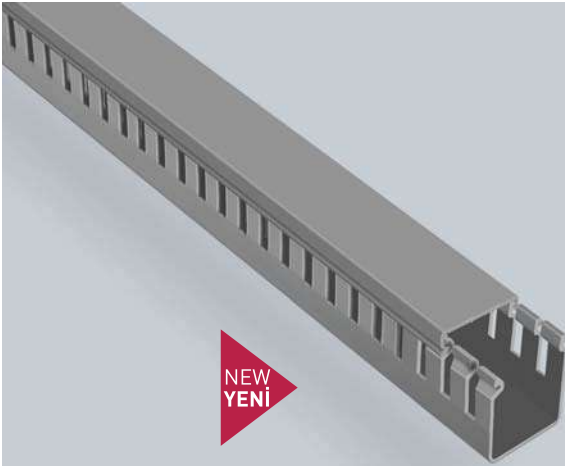

NEW
YENİ



Flame Retardant
Alev Yaymayan

25x25

Gri
Grey

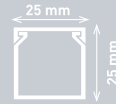

Ürün Kodu	Product Code	001 005 025025 20 17
Ambalaj Şekli	Packing Type	Kutu - Box
Adet / m	Quantity / m	128 m
Ağırlık	Weight	26.865 kg
m ³ /	Volume	0.0992

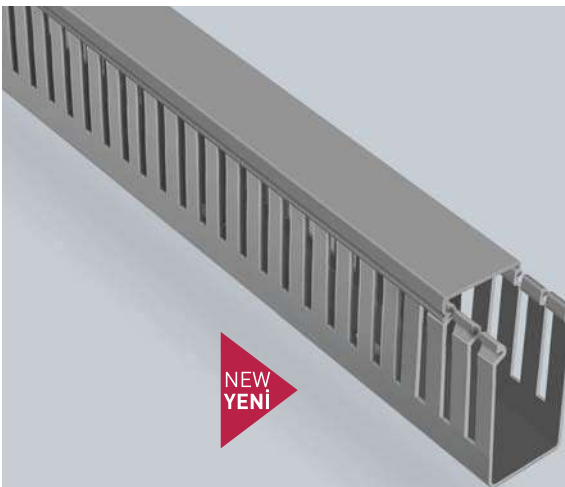

NEW
YENİ



Flame Retardant
Alev Yaymayan

25x40

Gri
Grey

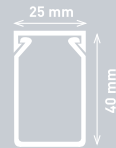

Ürün Kodu	Product Code	001 005 025040 20 17
Ambalaj Şekli	Packing Type	Kutu - Box
Adet / m	Quantity / m	80 m
Ağırlık	Weight	23,665 kg
m ³ /	Volume	0.0992

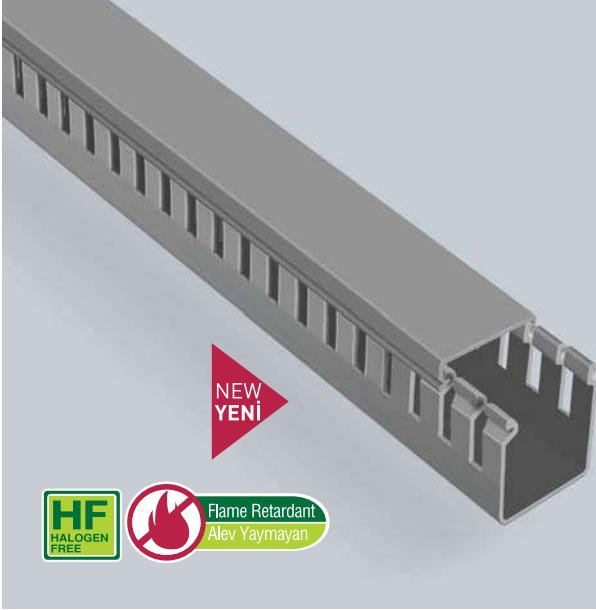
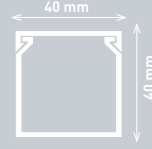
**40x40****Gri**
Grey

Ürün Kodu	Product Code	001 005 040040 20 17
Ambalaj Şekli	Packing Type	Kutu - Box
Adet / m	Quantity / m	50 m
Ağırlık	Weight	18.765 kg
m ³ /	Volume	0.0992

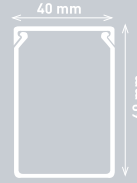
**40x60****Gri**
Grey

Ürün Kodu	Product Code	001 005 040060 20 17
Ambalaj Şekli	Packing Type	Kutu - Box
Adet / m	Quantity / m	48 m
Ağırlık	Weight	23.11 kg
m ³ /	Volume	0.1439

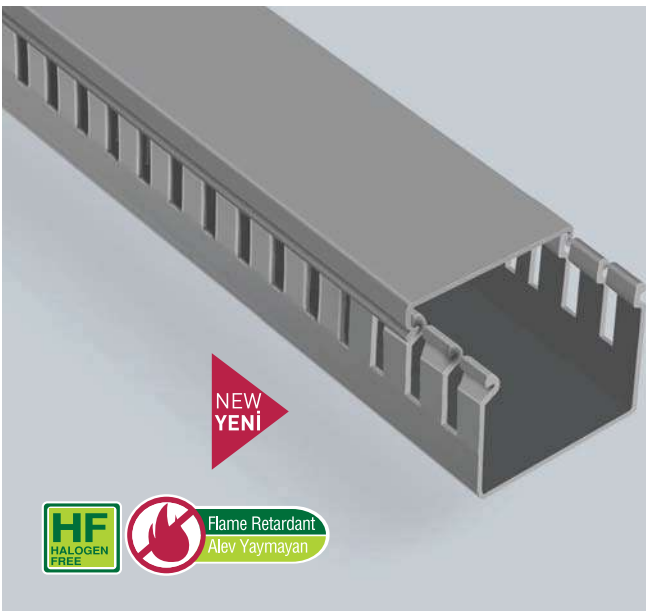
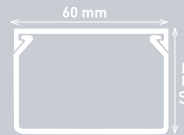
**60x40****Gri**
Grey

Ürün Kodu	Product Code	001 005 060040 20 17
Ambalaj Şekli	Packing Type	Kutu - Box
Adet / m	Quantity / m	48 m
Ağırlık	Weight	25.51 kg
m ³ /	Volume	0.1439

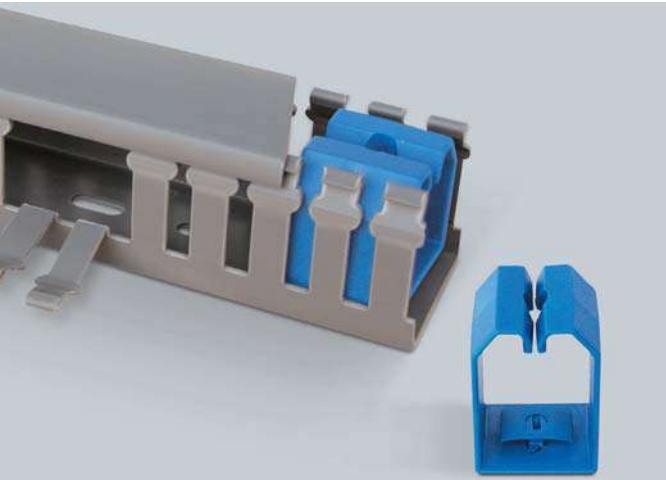
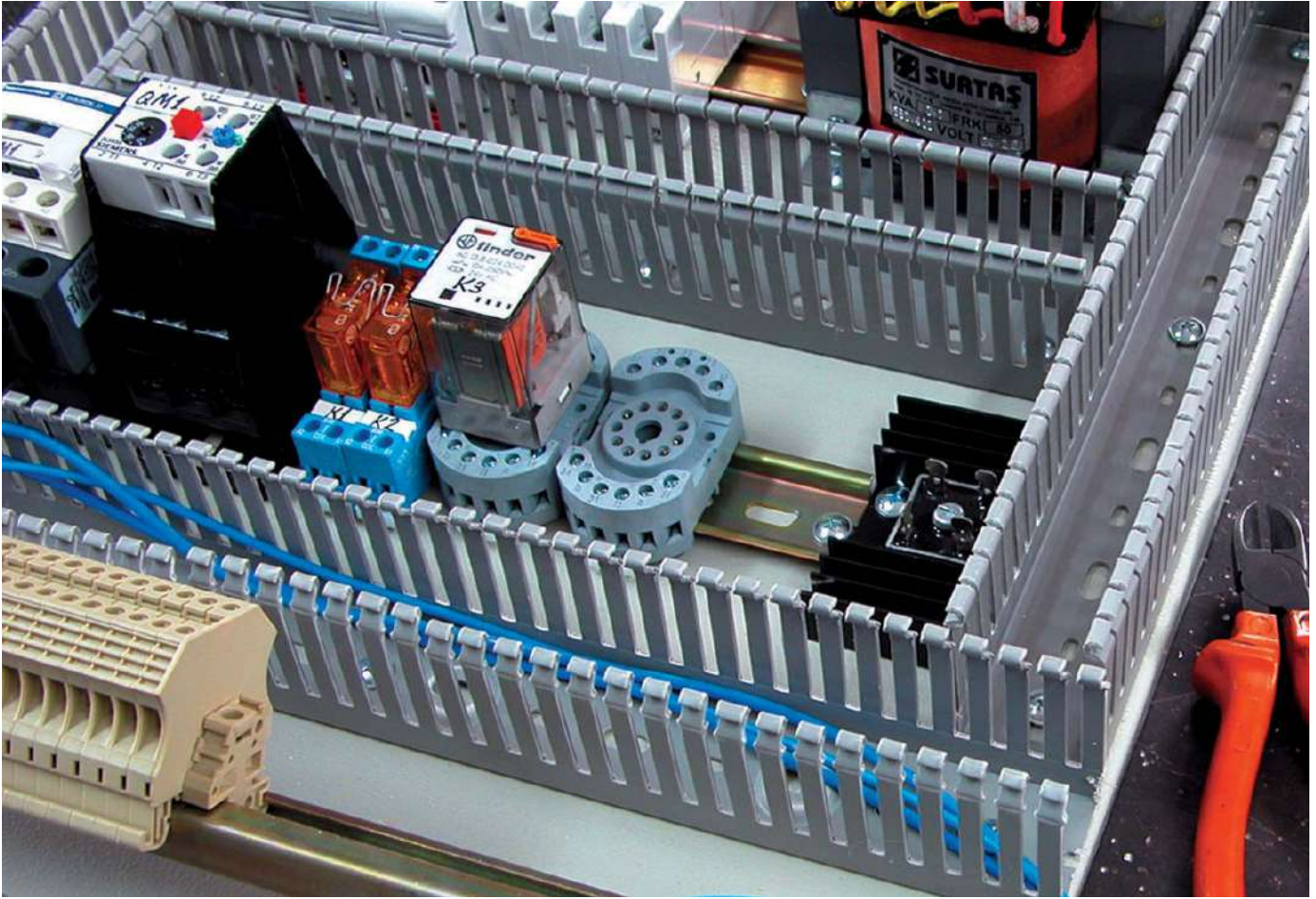

Kablo Tutucu Aparatı
Cable Holder Apparatus

		25x40	40x40	60x40
Ürün Kodu	Product Code	001 050 010001 00 00	001 050 010002 00 00	001 050 010003 00 00
Ambalaj Şekli	Packing Type	Kutu - Box	Kutu - Box	Kutu - Box
Adet / m	Quantity / m	- m	- m	- m
Ağırlık	Weight	- kg	- kg	- kg
m ³ /	Volume	-	-	-

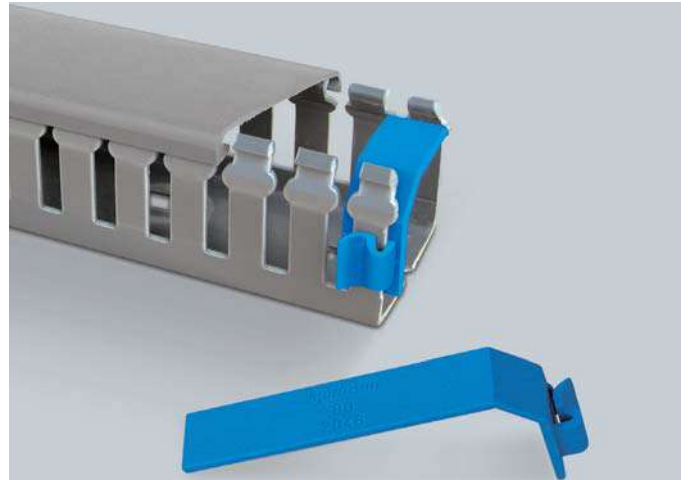

Kablo Tutucu Yan Aparatı
Cable Holder Side Apparatus

		40x40/60	60x40/60	80x60	100x60
Ürün Kodu	Product Code	001 050 020001 00 00	001 050 020002 00 00	001 050 020003 00 00	001 050 020004 00 00
Ambalaj Şekli	Packing Type	Kutu - Box	Kutu - Box	Kutu - Box	Kutu - Box
Adet / m	Quantity / m	- m	- m	- m	- m
Ağırlık	Weight	- kg	- kg	- kg	- kg
m ³ /	Volume	-	-	-	-

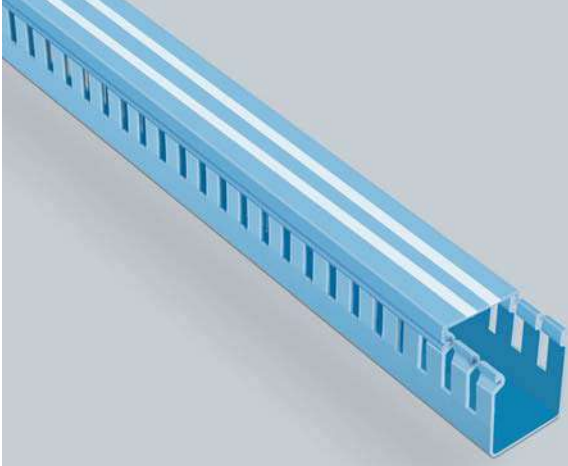
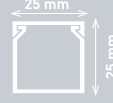
**25x25****Mavi**
Blue

Ürün Kodu	Product Code	001 005 025025 20 13
Ambalaj Şekli	Packing Type	Kutu - Box
Adet / m	Quantity / m	128 m
Ağırlık	Weight	26.865 kg
m ³ /	Volume	0.0992

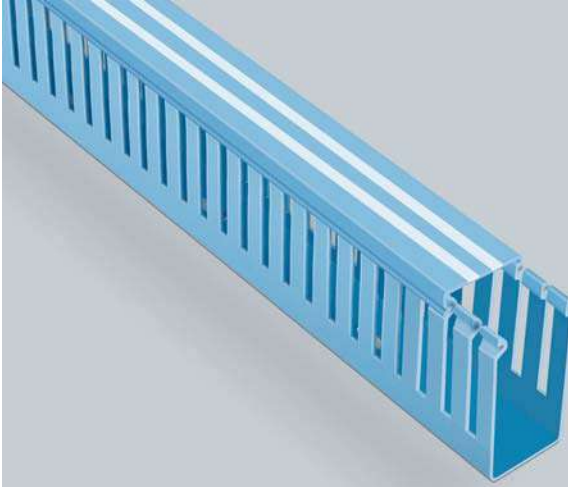
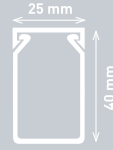
**25x40****Mavi**
Blue

Ürün Kodu	Product Code	001 005 025040 20 13
Ambalaj Şekli	Packing Type	Kutu - Box
Adet / m	Quantity / m	80 m
Ağırlık	Weight	23,665 kg
m ³ /	Volume	0.0992

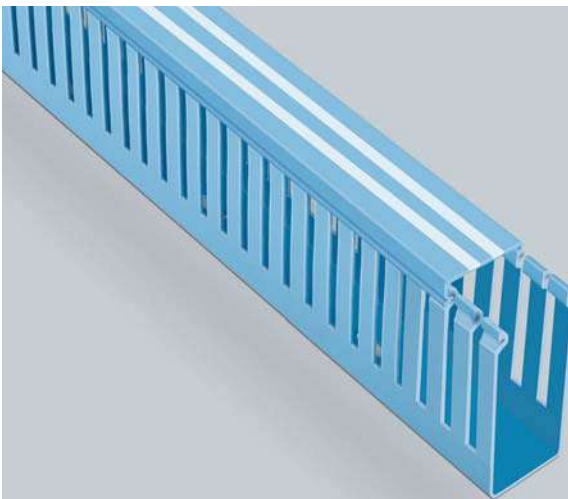
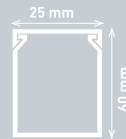
**25x60****Mavi**
Blue

Ürün Kodu	Product Code	001 005 025060 20 13
Ambalaj Şekli	Packing Type	Kutu - Box
Adet / m	Quantity / m	80 m
Ağırlık	Weight	33.51 kg
m ³ /	Volume	0.14392

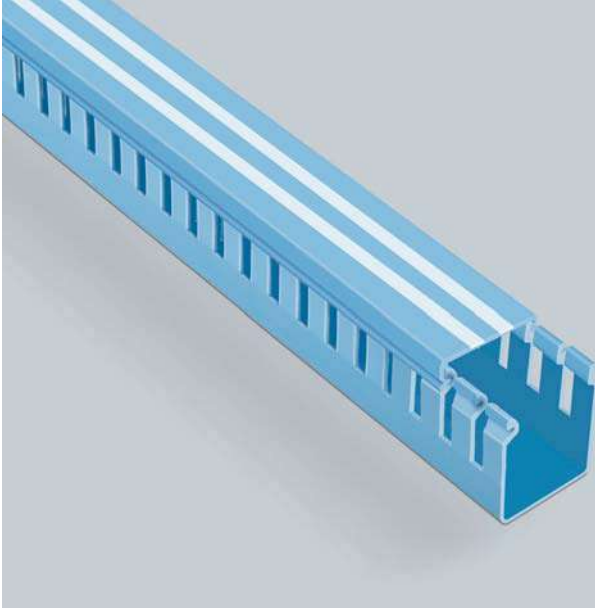
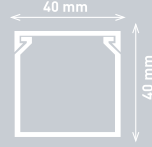
**40x40****Mavi**
Blue

Ürün Kodu	Product Code	001 005 040040 20 13
Ambalaj Şekli	Packing Type	Kutu - Box
Adet / m	Quantity / m	50 m
Ağırlık	Weight	18.765 kg
m ³ /	Volume	0.0992

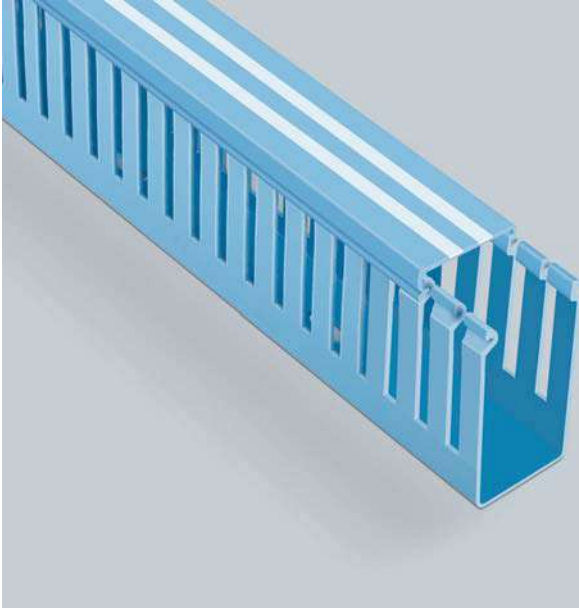
**40x60****Mavi**
Blue

Ürün Kodu	Product Code	001 005 040060 20 13
Ambalaj Şekli	Packing Type	Kutu - Box
Adet / m	Quantity / m	48 m
Ağırlık	Weight	23.11 kg
m ³ /	Volume	0.1439

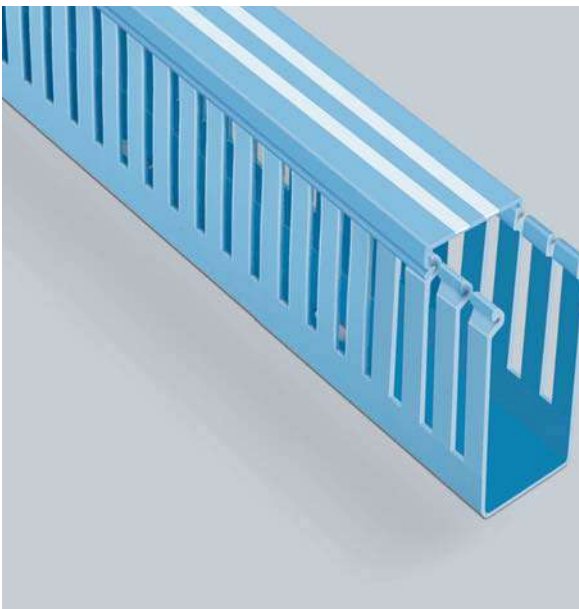
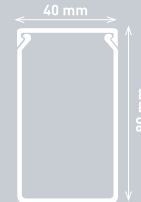
**40x80****Mavi**
Blue

Ürün Kodu	Product Code	001 005 040080 20 13
Ambalaj Şekli	Packing Type	Kutu - Box
Adet / m	Quantity / m	36 m
Ağırlık	Weight	20.23 kg
m ³ /	Volume	0.14393

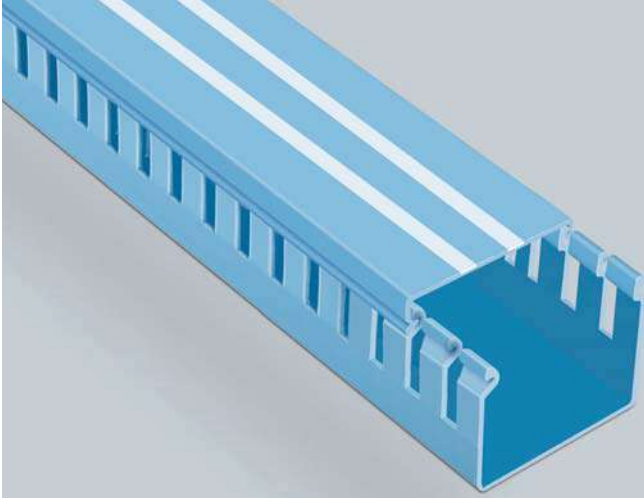
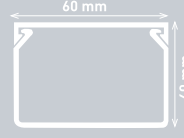
**60x40****Mavi**
Blue

Ürün Kodu	Product Code	001 005 060040 20 13
Ambalaj Şekli	Packing Type	Kutu - Box
Adet / m	Quantity / m	48 m
Ağırlık	Weight	25.51 kg
m ³ /	Volume	0.1439

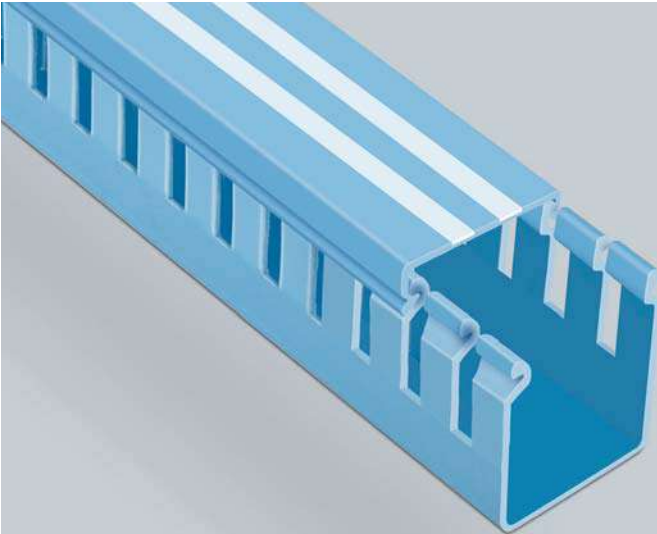
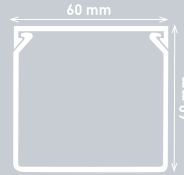
**60x60****Mavi**
Blue

Ürün Kodu	Product Code	001 005 060060 20 13
Ambalaj Şekli	Packing Type	Kutu - Box
Adet / m	Quantity / m	32 m
Ağırlık	Weight	19.11 kg
m ³ /	Volume	0.1439

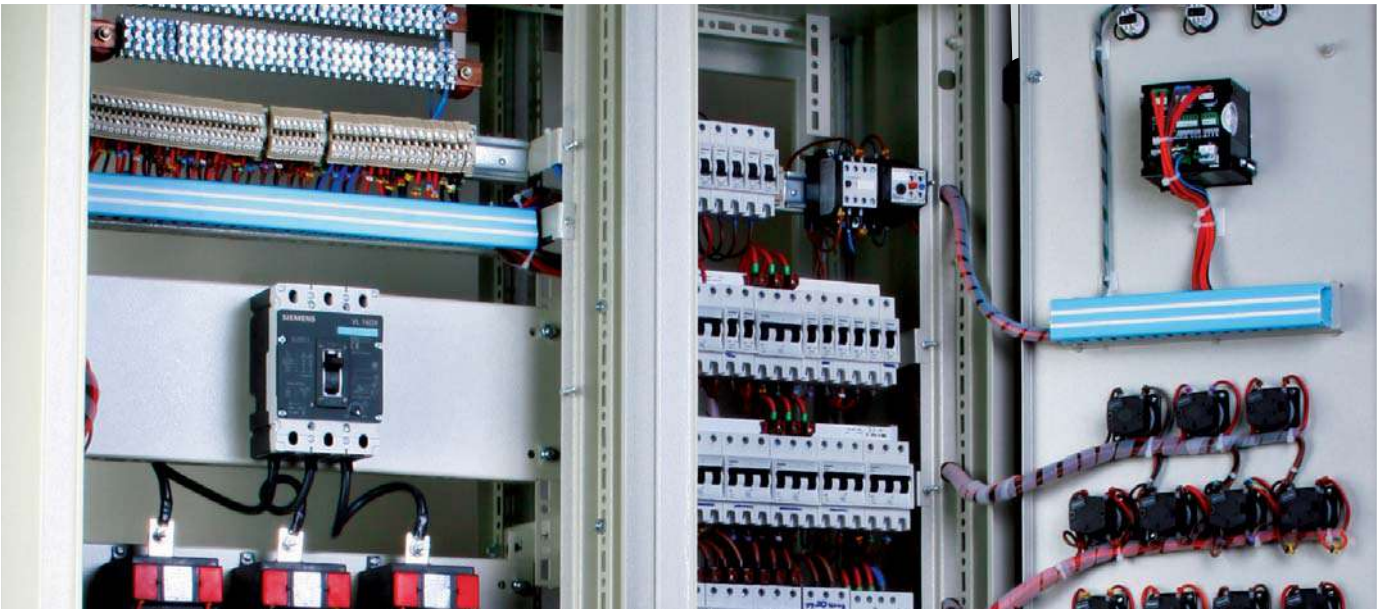

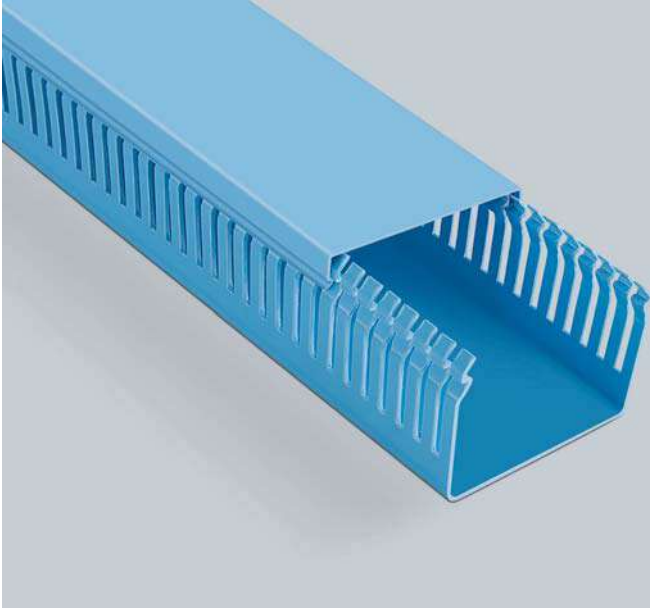
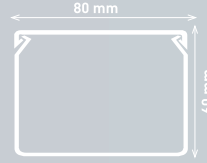
**80x60****Mavi**
Blue

Ürün Kodu	Product Code	001 005 080060 20 13
Ambalaj Şekli	Packing Type	Kutu - Box
Adet / m	Quantity / m	24 m
Ağırlık	Weight	16.63 kg
m ³ /	Volume	0.1439

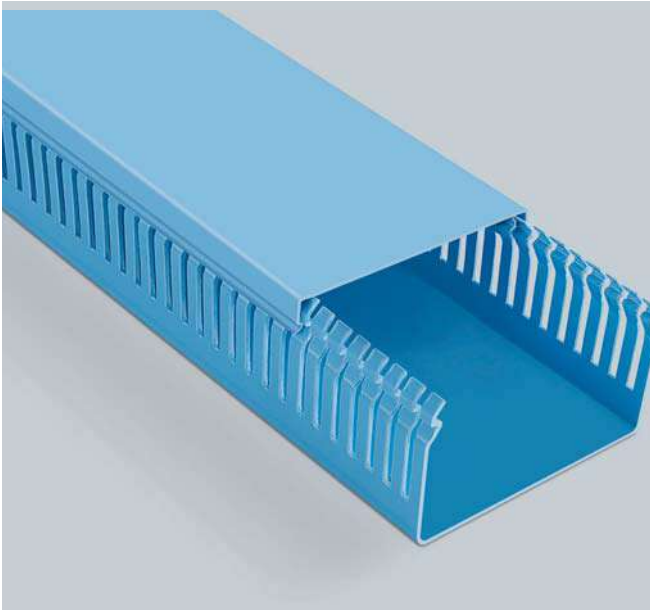
**100x60****Mavi**
Blue

Ürün Kodu	Product Code	001 005 100060 20 13
Ambalaj Şekli	Packing Type	Kutu - Box
Adet / m	Quantity / m	16 m
Ağırlık	Weight	14.31 kg
m ³ /	Volume	0.1170

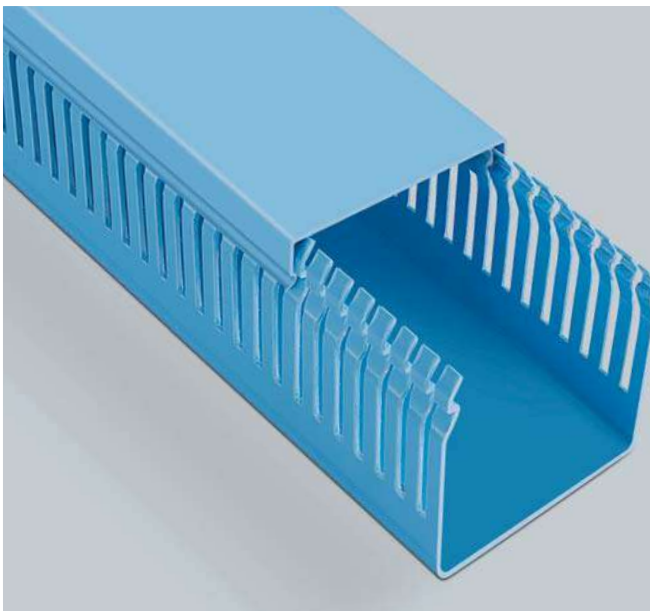
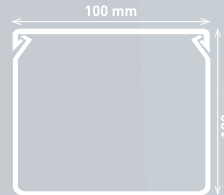
**100x100****Mavi**
Blue

Ürün Kodu	Product Code	001 005 100100 20 13
Ambalaj Şekli	Packing Type	Kutu - Box
Adet / m	Quantity / m	8 m
Ağırlık	Weight	10.55 kg
m ³ /	Volume	0.1170

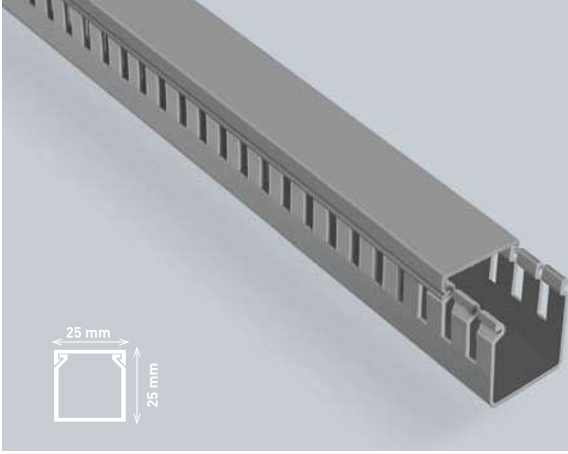
**25x25****Gri**
Grey

Ürün Kodu	Product Code	001 005 025025 20 17
Ambalaj Şekli	Packing Type	Kutu - Box
Adet / m	Quantity / m	128 m
Ağırlık	Weight	26.865 kg
m ³ /	Volume	0.0992

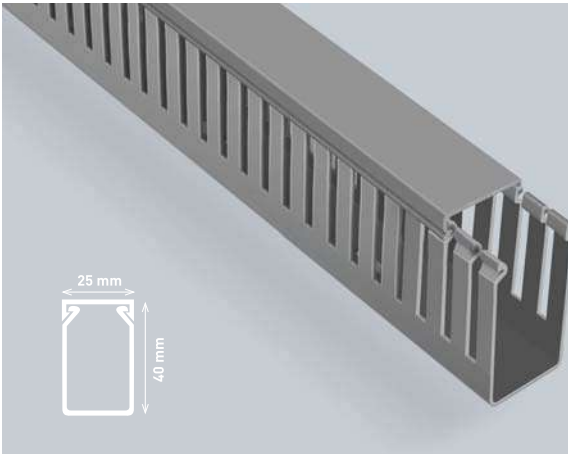
**25x40****Gri**
Grey

Ürün Kodu	Product Code	001 005 025040 20 17
Ambalaj Şekli	Packing Type	Kutu - Box
Adet / m	Quantity / m	80 m
Ağırlık	Weight	23,665 kg
m ³ /	Volume	0.0992

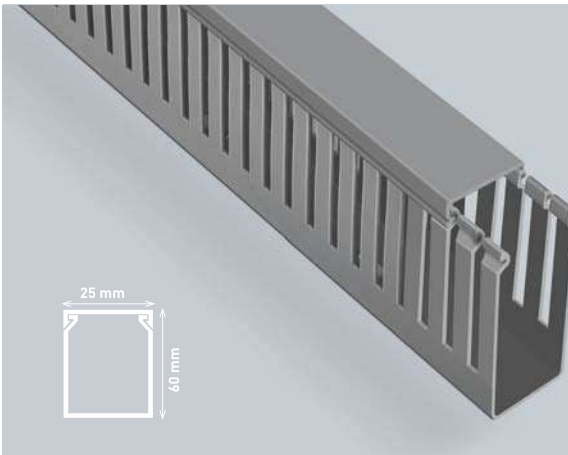
**25x60****Gri**
Grey

Ürün Kodu	Product Code	001 005 025060 20 17
Ambalaj Şekli	Packing Type	Kutu - Box
Adet / m	Quantity / m	80 m
Ağırlık	Weight	33.51 kg
m ³ /	Volume	0.14392

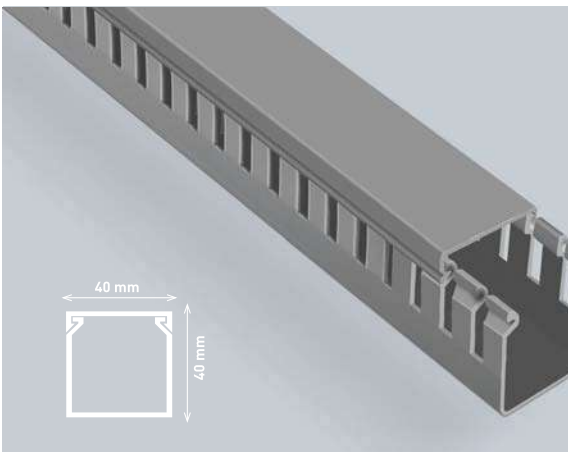
**40x40****Gri**
Grey

Ürün Kodu	Product Code	001 005 040040 20 17
Ambalaj Şekli	Packing Type	Kutu - Box
Adet / m	Quantity / m	50 m
Ağırlık	Weight	18.765 kg
m ³ /	Volume	0.0992

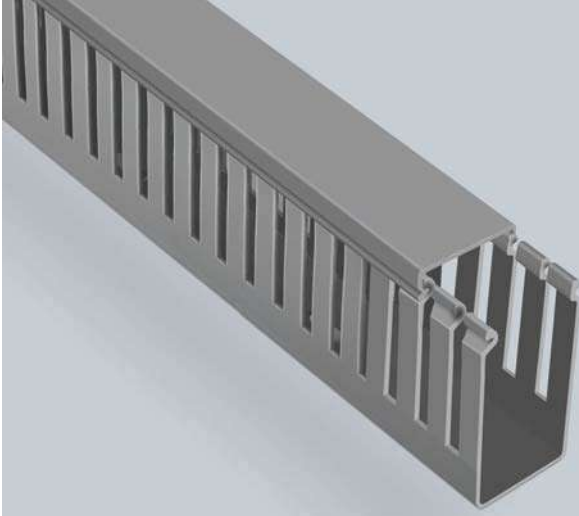
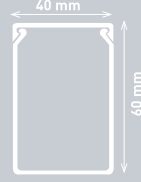
**40x60****Gri**
Grey

Ürün Kodu	Product Code	001 005 040060 20 17
Ambalaj Şekli	Packing Type	Kutu - Box
Adet / m	Quantity / m	48 m
Ağırlık	Weight	23.11 kg
m ³ /	Volume	0.1439

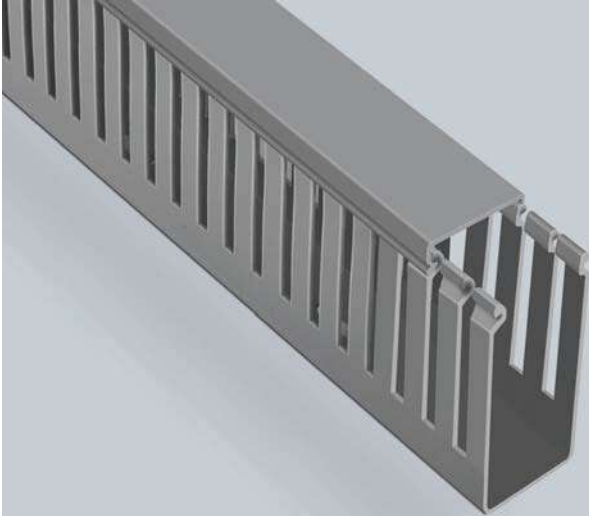
**40x80****Gri**
Grey

Ürün Kodu	Product Code	001 005 040080 20 17
Ambalaj Şekli	Packing Type	Kutu - Box
Adet / m	Quantity / m	36 m
Ağırlık	Weight	20.23 kg
m ³ /	Volume	0.14393

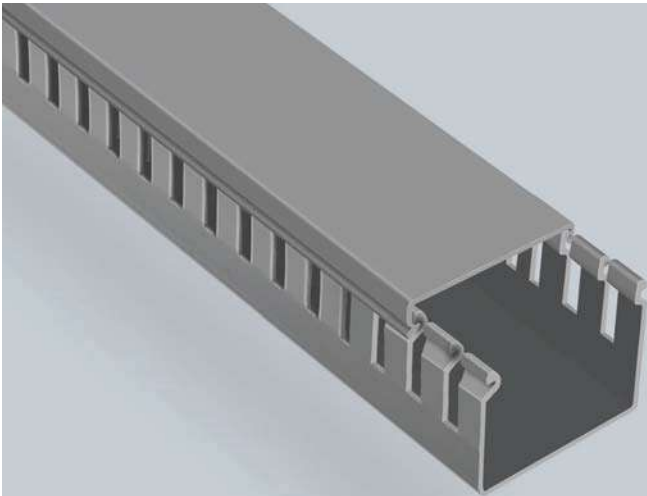
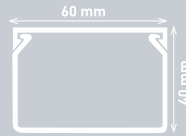
**60x40****Gri**
Grey

Ürün Kodu	Product Code	001 005 060040 20 17
Ambalaj Şekli	Packing Type	Kutu - Box
Adet / m	Quantity / m	48 m
Ağırlık	Weight	25.51 kg
m ³ /	Volume	0.1439

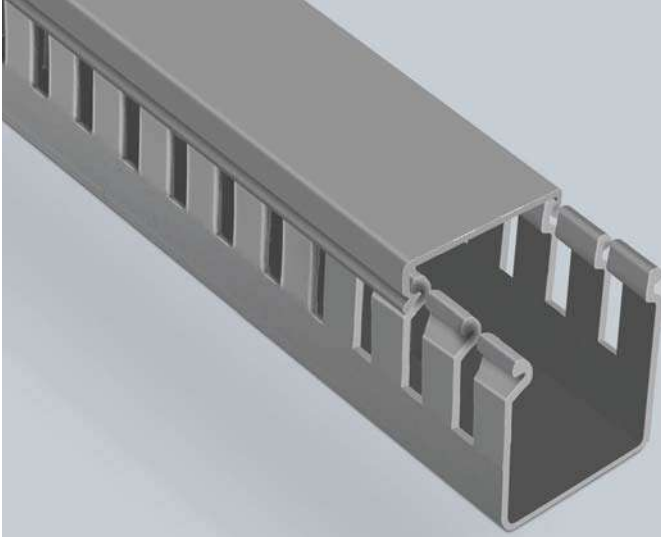
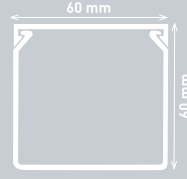
**60x60****Gri**
Grey

Ürün Kodu	Product Code	001 005 060060 20 17
Ambalaj Şekli	Packing Type	Kutu - Box
Adet / m	Quantity / m	32 m
Ağırlık	Weight	19.11 kg
m ³ /	Volume	0.1439

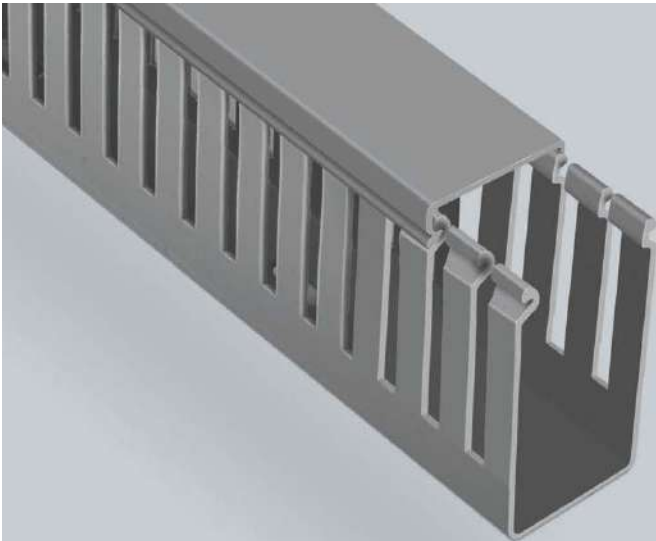
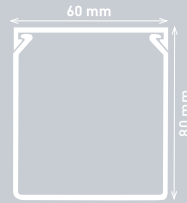
**60x80****Gri**
Grey

Ürün Kodu	Product Code	001 005 060080 20 17
Ambalaj Şekli	Packing Type	Kutu - Box
Adet / m	Quantity / m	24 m
Ağırlık	Weight	15.94 kg
m ³ /	Volume	0.1439

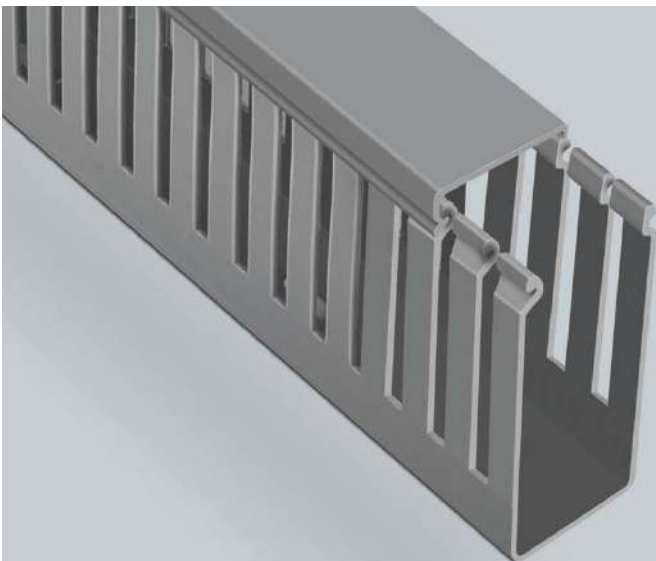
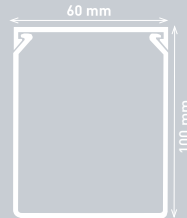
**60x100****Gri**
Grey

Ürün Kodu	Product Code	001 005 060100 20 17
Ambalaj Şekli	Packing Type	Kutu - Box
Adet / m	Quantity / m	16 m
Ağırlık	Weight	12.40 kg
m ³ /	Volume	0.1170

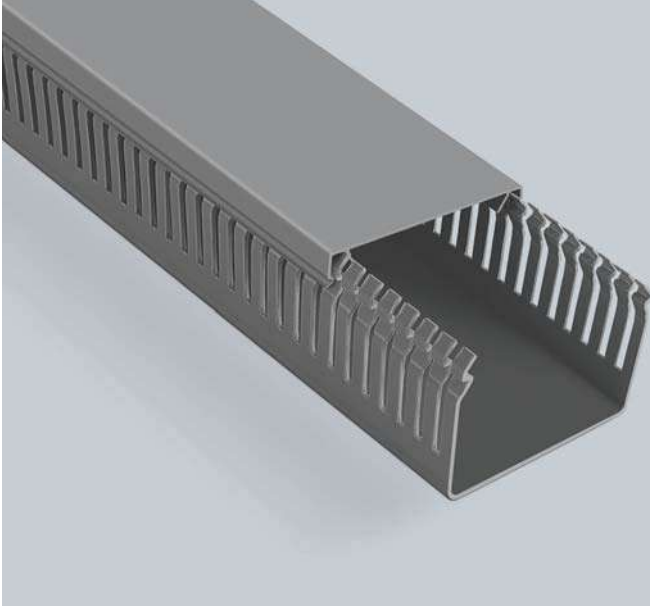
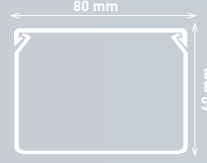
**80x60****Gri**
Grey

Ürün Kodu	Product Code	001 005 080060 20 17
Ambalaj Şekli	Packing Type	Kutu - Box
Adet / m	Quantity / m	24 m
Ağırlık	Weight	16.63 kg
m ³ /	Volume	0.1439

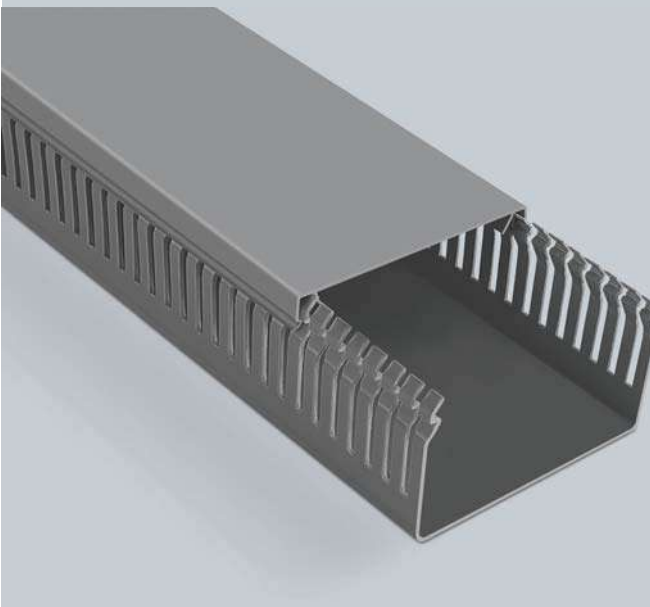
**100x60****Gri**
Grey

Ürün Kodu	Product Code	001 005 100060 20 17
Ambalaj Şekli	Packing Type	Kutu - Box
Adet / m	Quantity / m	16 m
Ağırlık	Weight	14.31 kg
m ³ /	Volume	0.1170

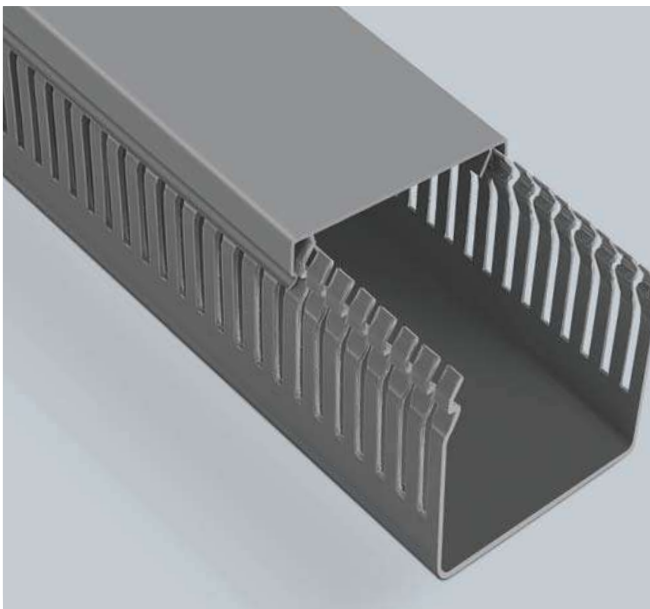
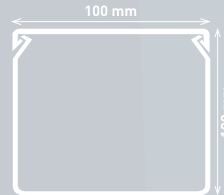
**100x100****Gri**
Grey

Ürün Kodu	Product Code	001 005 100100 20 17
Ambalaj Şekli	Packing Type	Kutu - Box
Adet / m	Quantity / m	8 m
Ağırlık	Weight	10.55 kg
m ³ /	Volume	0.1170



SANAYİ ÜRÜN GRUBU
INDUSTRIAL PRODUCT
GROUP

SANAYİ FİŞ - PRİZ GRUBU

PLUG - SOCKET GROUP

1x16A MONOFAZE	Kod Code	Açıklama Description	Ambalaj Packing	Adet Quantity	Ağırlık Weight	Hacim Volume
	010 083 300028	MUT-28 1x16 A. MONOFAZE TOPRAKLI ERKEK FİŞ (DÜZ) 1x16 A. MON.PHASE EARTHED PLUG	Kutu Pack	50	3.355 Kg	7.5
	010 083 300029	MUT-29 1x16 A. MONOFAZE TOPRAKLI DİŞİ FİŞ 1x16 A. MON.PHASE EARTHED SOCKET	Kutu Pack	30	3.655 Kg	7.5
	010 083 500296	MUT-296 1x16 A. MONOFAZE TOPRAKLI DUVAR PRİZİ 1x16 A. MON.PHASE EARTHED WALL SOCKET	Kutu Pack	24	3.355 Kg	7.5
	010 083 500292	MUT-292 1x16 A. MONOFAZE 2'Lİ TOPRAKLI GRUP RİZ 1x16 A. MON.PHASE 2 GANG EARTHED GROUP SOCKET	Kutu Pack	12	3.850 Kg	7.5
	010 083 501292	MUT-292A 1x16 A. MONOFAZE 2'Lİ TOPRAKLI GRUP PRİZ ANAHTARLI 1x16 A. MON.PHASE 2 GANG EARTHED GROUP SOCKET (WITH SWITCH)	Kutu Pack	12	3.900 Kg	7.5
	010 083 501293	1X16 A. MONOFAZE 3'LÜ GR.PRİZ ANAHTARLI 10/80 1X16 A. MON.PHASE 3 GANG GROUP SOCKET (WITH SWITCH) 10/80	Kutu Pack	10	4.110 Kg	7.5
	010 083 500293	MUT-293 1x16 A. MONOFAZE 3'LÜ TOPRAKLI GRUP RİZ 1x16 A. MON.PHASE 3 GANG EARTHED GROUP SOCKET	Kutu Pack	10	4.110 Kg	7.5

SANAYİ FİŞ - PRİZ GRUBU

PLUG - SOCKET GROUP

1x16A MONOFAZE	Kod Code	Açıklama Description	Ambalaj Packing	Adet Quantity	Ağırlık Weight	Hacim Volume
	010 083 500298	MUT-298 MONOFAZE TOPRAKLI PANO PRİZİ MON.PHASE EARTHED PANEL SOCKET	Kutu Pack	40	2.160 Kg	7.5
	010 083 501297	MUT-298U MONOFAZE UPS TOPRAKLI PANO PRİZİ MON.PHASE EARTHED UPS PANEL SOCKET	Kutu Pack	40	2.200 Kg	7.5
	010 083 500297	MUT-297 MONOFAZE DUVAR PRİZİ (PLASTİK) MON.PHASE WALL SOCKET (PLASTIC)	Kutu Pack	30	2.000 Kg	7.5
	010 083 500299	MUT-299 MONOFAZE MAKİNA PRİZİ MON.PHASE AUTOMATION SOCKET	Kutu Pack	20	2.400 Kg	7.5
	010 083 502910	MUT-2910 MONOFAZE DUVAR PRİZİ MON.PHASE WALL SOCKET	Kutu Pack	15	2.650 Kg	7.5

SANAYİ FİŞ - PRİZ GRUBU

PLUG - SOCKET GROUP

3x16A TRİFAZE	Kod Code	Açıklama Description	Ambalaj Packing	Adet Quantity	Ağırlık Weight	Hacim Volume
	010 083 400060	MUT-60 3x16 A. TRİFAZE ERKEK FİŞ 3x16 A. THREE PHASE PLUG	Kutu Pack	30	3.700 Kg	7.5
	010 083 400061	MUT-61 3x16 A. TRİFAZE SEYYAR DIŞI FİŞ 3x16 A. THREE PHASE PORTABLE SOCKET	Kutu Pack	25	4.500 Kg	7.5
	010 083 400062	MUT-62 3x16 A. TRİFAZE DUVAR PRİZİ 3x16 A. THREE PHASE WALL SOCKET	Kutu Pack	20	4.600 Kg	7.5
	010 083 400063	MUT-63 3x16 A. TRİFAZE DUVAR PRİZİ (PLASTİK) 3x16 A. THREE PHASE WALL SOCKET (PLASTIC)	Kutu Pack	12	2.750 Kg	7.5
	010 083 400064	MUT-64 3x16 A. TRİFAZE MAKİNA PRİZİ (PLASTİK) 3x16 A. THREE PHASE AUTOMATION SOCKET (PLASTIC)	Kutu Pack	20	2.500 Kg	7.5

MUTLUSAN CEE NORM SANAYİ TİPİ FİŞ VE PRİZ GRUBU

PLUG - SOCKET GROUP

CEE NORM	Kod Code	Açıklama Description	Ambalaj Packing	Adet Quantity	Ağırlık Weight	Hacim Volume
	010 083 000516	MUT-101 CEE NORM 5x16 A. DÜZ FİŞ CEE NORM 5x16 A. DÜZ FİŞ	Kutu Pack	16	2.720 Kg	0.0133
	010 083 010516	MUT-102 CEE NORM 5x16 A. UZATMA PRİZİ CEE NORM 5x16 A. DÜZ FİŞ	Kutu Pack	15	3.105 Kg	0.0133
	010 083 020516	MUT-103 CEE NORM 5x16 A. MAKİNA PRİZİ CEE NORM 5x16 A. DÜZ FİŞ	Kutu Pack	20	3.750 Kg	0.0133
	010 083 030516	MUT-104 CEE NORM 5x16 A. DUVAR PRİZİ CEE NORM 5x16 A. DÜZ FİŞ	Kutu Pack	8	1.500 Kg	0.0053
	010 083 000532	MUT-101 CEE NORM 5x32 A. DÜZ FİŞ CEE NORM 5x16 A. DÜZ FİŞ	Kutu Pack	16	2.720 Kg	0.0133
	010 083 010532	MUT-102 CEE NORM 5x32 A. UZATMA PRİZİ CEE NORM 5x16 A. DÜZ FİŞ	Kutu Pack	15	3.105 Kg	0.0133
	010 083 020532	MUT-103 CEE NORM 5x32 A. MAKİNA PRİZİ CEE NORM 5x16 A. DÜZ FİŞ	Kutu Pack	20	3.750 Kg	0.0133
	010 083 030532	MUT-104 CEE NORM 5x32 A. DUVAR PRİZİ CEE NORM 5x16 A. DÜZ FİŞ	Kutu Pack	8	1.500 Kg	0.0053

SANAYİ FİŞ - PRİZ GRUBU

PLUG - SOCKET GROUP

3x25A TRİFAZE	Kod Code	Açıklama Description	Ambalaj Packing	Adet Quantity	Ağırlık Weight	Hacim Volume
	010 083 400030	MUT-30 3x25 A. TRİFAZE ERKEK FİŞ 3x25 A. THREE PHASE PLUG	Kutu Pack	30	3.250 Kg	7.5
	010 083 400031	MUT-31 3x25 A. TRİFAZE SEYYAR DİŞİ FİŞ 3x25 A. THREE PHASE PORTABLE SOCKET	Kutu Pack	25	4.605 Kg	7.5
	010 083 600315	MUT-315 3x25 A. TRİFAZE DUVAR PRİZİ 3x25 A. THREE PHASE WALL SOCKET	Kutu Pack	24	4.800 Kg	7.5
	010 083 400319	MUT-19 3x25 A. TRİFAZE DUVAR PRİZİ (PLASTİK) 3x25 A. THREE PHASE WALL SOCKET (PLASTIC)	Kutu Pack	15	3.000 Kg	7.5
	010 083 400318	MUT-318 3x25 A. TRİFAZE MAKİNA PRİZİ (PLASTİK) 3x25 A. THREE PHASE AUTOMATION SOCKET (PLASTIC)	Kutu Pack	20	2.500 Kg	7.5
	010 083 600311	MUT-311 1 TRİFAZE + 1 MONOFAZE 2'Lİ GRUP PRİZ 1 THREE PHASE + 1 MON.PHASE 2 GANG GROUP SOCKET	Kutu Pack	10	3.650 Kg	7.5
	010 083 600312	MUT-312 TRİFAZE 2'Lİ GRUP PRİZ THREE PHASE 2 GANG GROUP SOCKET	Kutu Pack	10	3.750 Kg	7.5
	010 083 600313	MUT-313 TRİFAZE 3'LÜ GRUP PRİZ THREE PHASE 3 GANG GROUP SOCKET	Kutu Pack	8	4.160 Kg	7.5







SANAYİ FİŞ - PRİZ GRUBU

PLUG - SOCKET GROUP

1x16A MONOFAZE	Kod Code	Açıklama Description	Ambalaj Packing	Adet Quantity	Ağırlık Weight	Hacim Volume
	010 083 600316	MUT-316 2 TRİFAZE + 1 MONOFAZE 3'LÜ GRUP PRİZ 2 THREE PHASE + 1 MON.PHASE 3 GANG GROUP SOCKET	Kutu Pack	8	3.950 Kg	7.5
	010 083 600317	MUT-317 1 TRİFAZE + 2 MONOFAZE 3'LÜ GRUP PRİZ 1 THREE PHASE + 2 MON.PHASE 3 GANG GROUP SOCKET	Kutu Pack	8	3.750 Kg	7.5
3x32A TRİFAZE	Kod Code	Açıklama Description	Ambalaj Packing	Adet Quantity	Ağırlık Weight	Hacim Volume
	010 083 400070	MUT-70 3x32 A. TRİFAZE ERKEK FİŞ 3x32 A. THREE PHASE PLUG	Kutu Pack	20	4.650 Kg	7.5
	010 083 400071	MUT-71 3x32 A. TRİFAZE SEYYAR DİŞİ FİŞ 3x32 A. THREE PHASE PORTABLE SOCKET	Kutu Pack	20	4.800 Kg	7.5
	010 083 400072	MUT-72 3x32 A. TRİFAZE DUVAR PRİZİ 3x32 A. THREE PHASE WALL SOCKET	Kutu Pack	20	4.800 Kg	7.5
	010 083 400073	MUT-73 3x32 A. TRİFAZE DUVAR PRİZİ (PLASTİK) 3x32 A. THREE PHASE WALL SOCKET (PLASTIC)	Kutu Pack	12	2.750 Kg	7.5
	010 083 400074	MUT-374 3x32 A. TRİFAZE MAKİNA PRİZİ (PLASTİK) 3x32 A. THREE PHASE AUTOMATION SOCKET (PLASTIC)	Kutu Pack	20	2.500 Kg	7.5

SİNYAL VE KUMANDA BUTONLARI

SIGNAL AND CONTROL BUTTONS

	Kod Code	Açıklama Description	Ambalaj Packing	Adet Quantity	Ağırlık Weight	Hacim Volume	Renk Color
	010 090 010001	10mm Sinyal Armatürü 10mm Signal Luminaire Neon Lamp - 220V Silikon Kablo / Silicon Cable	Kutu Pack	100	0.30 Kg	0.001	<ul style="list-style-type: none"> ● Kırmızı / Red ● Yeşil / Green ● Sarı / Yellow ● Mavi / Blue ● Beyaz / White
	010 090 010005	14mm Sinyal Armatürü 14mm Signal Luminaire 12 V - Neon Lamp	Kutu Pack	50	0.340 Kg	0.001	<ul style="list-style-type: none"> ● Kırmızı / Red ● Yeşil / Green ● Sarı / Yellow ● Mavi / Blue ● Beyaz / White
	010 090 010006	24 V					
	010 090 010007	220 V					
	010 090 010008	22mm Sinyal Armatürü 22mm Signal Luminaire 12 V - Neon Lamp	Kutu Pack	24	0.46 Kg	0.001	<ul style="list-style-type: none"> ● Kırmızı / Red ● Yeşil / Green ● Sarı / Yellow ● Mavi / Blue ● Beyaz / White
	010 090 010009	24 V					
	010 090 010010	220 V					
	010 090 010002	Ba9s Duylu Ledli 22mm Sinyal Armatürü (24V-220V) 22 mm Ba9s Signal Luminaire with lamp base and LED light (24V-220V)	Kutu Pack	24	0.55 Kg	0.001	<ul style="list-style-type: none"> ● Kırmızı / Red ● Yeşil / Green ● Sarı / Yellow ● Mavi / Blue ● Beyaz / White
	010 090 010003	Ba9s Duylu Neon 22mm Sinyal Armatürü (24V-220V) 22 mm Ba9s Signal Luminaire with lamp base and Neon light (24V-220V)					
	010 111 070002	Led'li Buzzer Buzzer with LED 24 V	Kutu Pack	-	-	-	
	010 111 070001	220 V					
	010 111 070004	Buzzer Buzzer 24 V					
	010 111 070003	220 V					
	010 090 010004	Ba9s Duylu Ledli Işık Soketli Adaptörlü 22mm Sinyal Armatürü 22 mm Ba9s Signal Luminaire with lamp base, LED light socket	Kutu Pack	20	0.60 Kg	0.002	<ul style="list-style-type: none"> ● Kırmızı / Red ● Yeşil / Green ● Sarı / Yellow ● Mavi / Blue ● Beyaz / White
	010 090 040001	Yaylı Start Butonu Spring Start Button	Kutu Pack	20	0.56 Kg	0.002	<ul style="list-style-type: none"> ● Yeşil / Green ● Sarı / Yellow ● Mavi / Blue ● Beyaz / White
	010 090 040002	Yaylı Stop Butonu Spring Start Button					<ul style="list-style-type: none"> ● Kırmızı / Red

SİNYAL VE KUMANDA BUTONLARI

SIGNAL AND CONTROL BUTTONS

	Açıklama Description	Kontakt Contact	Devre Circuit	Ambalaj Packing	Adet Quantity	Ağırlık Weight	Hacim Volume	Renk Color
	Ba9s Neon Ampüllü Yaylı Işıklı Start Butonu Ba9s Illuminated Spring Loaded Start Button with Neon Lamp	1 N / A 1 N/O		Kutu Pack	20	0.80 Kg	0.003	● Yeşil / Green ● Sarı / Yellow ● Mavi / Blue ● Beyaz / White
	Ba9s Neon Ampüllü Yaylı Işıklı Stop Butonu Ba9s Illuminated Spring Loaded Stop Button with Neon Lamp	1 N / A 1 N/O		Kutu Pack	20	0.82 Kg	0.002	● Kırmızı / Red
	Ba9s Ledli Yaylı Işıklı Start Butonu Ba9s Illuminated Spring Loaded Start Button with LED	1 N / A 1 N/O		Kutu Pack	20	0.80 Kg	0.001	● Yeşil / Green ● Sarı / Yellow ● Mavi / Blue ● Beyaz / White
	Ba9s Ledli Yaylı Işıklı Stop Butonu Ba9s Illuminated Spring Loaded Stop Button with LED	1 N / A 1 N/O		Kutu Pack	20	0.80 Kg	0.001	
	Yaylı Mantar Kafa Buton Start Spring Loaded Mushroom Shaped Start Button			Kutu Pack	12	0.53 Kg	0.001	● Yeşil / Green
	Yaylı Mantar Kafa Buton Stop Spring Loaded Mushroom Shaped Stop Button				12	0.54 Kg	0.001	● Siyah / Black ● Kırmızı / Red
	Ba9s Ledli Işıklı Seçici Buton 0-1 Ba9s Illuminated Selector Button with LED 0-1			Kutu Pack	12	0.52 Kg	0.001	● Yeşil / Green
	Ba9s Ledli Işıklı Seçici Buton 11-0-1 Ba9s Illuminated Spring Loaded Stop Button with LED 11-0-1				12	0.60Kg	0.001	● Yeşil / Green
	Eski Tip Start-Stop Butonu Çift Kontak Vintage Start-Stop Button Double Contact			Kutu Pack	20	0.80 Kg	0.002	● Kırmızı / Red ● Yeşil / Green ● Sarı / Yellow ● Mavi / Blue ● Beyaz / White

SİNYAL VE KUMANDA BUTONLARI

SIGNAL AND CONTROL BUTTONS

	Açıklama Description	Kontakt Contact	Devre Circuit	Ambalaj Packing	Adet Quantity	Ağırlık Weight	Hacim Volume	Renk Color
	Eski Tip Start Butonu Tek Kontakt Vintage Start Button Single Contact			Kutu Pack	20	0.80 Kg	0.002	<ul style="list-style-type: none"> ● Yeşil / Green ● Sarı / Yellow ● Mavi / Blue ● Beyaz / White
	Eski Tip Stop Butonu Tek Kontakt Vintage Stop Button Single Contact			Kutu Pack	20	0.70 Kg	0.002	<ul style="list-style-type: none"> ● Kırmızı / Red
	Acil Stop Butonu Emergency Stop Button Ø30	1 N / K 1 N / C		Kutu Pack	12	0.50 Kg	0.001	<ul style="list-style-type: none"> ● Kırmızı / Red
	Acil Stop Butonu Emergency Stop Button Ø40			Kutu Pack	12	0.54 Kg	0.001	<ul style="list-style-type: none"> ● Kırmızı / Red
	Anahtarlı Acil Stop Butonu Emergency Stop Button with key Ø40	1 N / K 1 N / C		Kutu Pack	12	0.88 Kg	0.001	<ul style="list-style-type: none"> ● Kırmızı / Red
	Yaylı İki Buton Spring-Loaded Double Button	1 N / A 1 N / O 1 N / K 1 N / C		Kutu Pack	14	0.59 Kg	0.002	<ul style="list-style-type: none"> ● Kırmızı / Red ● Yeşil / Green

SİNYAL VE KUMANDA BUTONLARI

SIGNAL AND CONTROL BUTTONS

	Açıklama Description	Kontak Contact	Devre Circuit	Ambalaj Packing	Adet Quantity	Ağırlık Weight	Hacim Volume	Renk Color
	Yaylı Işıklı İkiz Buton Spring-Loaded Illuminated Double Button	1 N / A 1 N / O 1 N / K 1 N / C		Kutu Pack	14	0.56 Kg	0.001	● Kırmızı / Red ● Yeşil / Green
010 090 040006								
	Seçici Buton Selector Button O-I O-I	1 N / A 1 N / O		Kutu Pack	12	0.39 Kg	0.001	● Siyah / Black
010 090 030001								
	Anahtarlı Seçici Buton Selector Button with Key O-I O-I	1 N / A 1 N / O		Kutu Pack	12	0.65 Kg	0.001	● Siyah / Black
010 090 030007								
	Seçici Buton Selector Button II-O-I II-O-I	2 N / A 2 N / O		Kutu Pack	12	0.52 Kg	0.001	● Siyah / Black
010 090 030002								
	Anahtarlı Seçici Buton Selector Button with Key II-O-I II-O-I	2 N / A 2 N / O		Kutu Pack	12	0.77 Kg	0.001	● Siyah / Black
010 090 030008								
	Ba9s Neon Ampullü Işıklı Seçici Buton Illuminated Selector Button with Ba9s Neon Lamp O-I O-I	1 N / A 1 N / O		Kutu Pack	12	0.52 Kg	0.001	● Yeşil / Green
010 090 030005								

SİNYAL VE KUMANDA BUTONLARI

SIGNAL AND CONTROL BUTTONS

	Açıklama Description	Kontakt Contact	Devre Circuit	Ambalaj Packing	Adet Quantity	Ağırlık Weight	Hacim Volume	Renk Color
 010 090 030006	Işıklı Seçici Buton Illuminated Selector Button II-O-I II-Ö-I	2 N / A 2 N / O		Kutu Pack	12	0.62 Kg	0.001	● Yeşil / Green
 010 091 020002	Yön İşaretili Start Butonu Start Button With Direction Marker			Kutu Pack	20	0.58 Kg	0.002	
 010 093 000003	Acil Durdurma Etiket Emergency Stop Tag Ø60mm			Kutu Pack	50	0.07 Kg	0.0001	● Sarı / Yellow
 010 093 000001	Silikon Toz Kılıfı Silicon Dustsheet			Kutu Pack	50	0.10 Kg	0.001	● Şeffaf / Lens
 010 090 050008	Emniyet Basma Düğmesi Muhafazası Safety Push Button Housing			Kutu Pack	50	0.23 Kg	0.002	● Sarı / Yellow
 010 093 000002	Buton Etiket Button Tag			Kutu Pack	50	0.08Kg	0.004	● Siyah / Black
 010 093 000004	Yedek Kontakt Blok Reserve Contact Block			Kutu Pack	50	0.55 Kg	0.002	● Kırmızı / Red ● Yeşil / Green
 010 093 000005	Işık Soketi Light Socket			Kutu Pack	50	0.47 Kg	0.002	

ETANJ BUTON KUTULARI

WATERPROOF BUTTON BOXES

	Açıklama Description	Ambalaj Packing	Adet Quantity	Ağırlık Weight	Hacim Volume	Renk Color
 010 091 010001	1'li Etanj Buton Kutusu Water Proof Button Box, Single (New Model) Ø 22mm IP 54 Ø 25mm	Kutu Pack	24	1.99 Kg	0.008	 Sarı-Siyah / Yellow-Black  Gri-Siyah / Grey-Black
 010 091 010002	2'li Etanj Buton Kutusu Water Proof Button Box, Double (New Model) Ø 22mm IP 54 Ø 25mm	Kutu Pack	16	1.94 Kg	0.008	 Sarı-Siyah / Yellow-Black  Gri-Siyah / Grey-Black
 010 091 010003	3'lü Etanj Buton Kutusu Water Proof Button Box, Triple (New Model) Ø 22mm IP 54 Ø 25mm	Kutu Pack	8	1.30 Kg	0.007	 Sarı-Siyah / Yellow-Black  Gri-Siyah / Grey-Black
 010 091 010004	4'lü Etanj Buton Kutusu Water Proof Button Box, Quadruple (New Model) Ø 22mm IP 54 Ø 25mm	Kutu Pack	8	1.50 Kg	0.007	 Sarı-Siyah / Yellow-Black  Gri-Siyah / Grey-Black
 010 091 020001	Asansör Revizyon Kutusu Elevator Revision Box	Kutu Pack	6	1.94 Kg	0.007	 Sarı-Siyah / Yellow-Black  Gri-Siyah / Grey-Black
 010 090 050009	Tekli Acil Stoplu Kutu Box Emergency Stop, Single	Kutu Pack	18	2.25 Kg	0.007	 Sarı-Siyah / Yellow-Black  Gri-Siyah / Grey-Black

VİNÇ KUMANDA BUTONLARI

CRANE CONTROL BUTTONS

	Açıklama Description	Kontakt Contact	Ambalaj Packing	Adet Quantity	Ağırlık Weight	Hacim Volume
 010 092 000001	2'li Vinç Kutusu (Tek Hızlı) Crane Box, Double (Single Speed) IP 65	1 N / A 1 N / 0 1 N / K 1 N / C	Kutu Pack	1	0.53 Kg	0.003
 010 092 000002	3'lü Vinç Kutusu (Tek Hızlı) Crane Box, Triple (Single Speed) IP 65	1 N / A 1 N / 0 1 N / K 1 N / C	Kutu Pack	1	0.56 Kg	0.003
 010 092 000003	4'lü Vinç Kutusu (Tek Hızlı) Crane Box, Quadruple (Single Speed) IP 65	1 N / A 1 N / 0 1 N / K 1 N / C	Kutu Pack	1	0.66 Kg	0.003
 010 092 000004	5'li Vinç Kutusu (Tek Hızlı) Crane Box, Quintet (Single Speed) IP 65	1 N / A 1 N / 0 1 N / K 1 N / C	Kutu Pack	1	0.66 Kg	0.003
 010 092 000005	6'li Vinç Kutusu (Tek Hızlı) Crane Box, Sextet (Single Speed) IP 65	1 N / A 1 N / 0 1 N / K 1 N / C	Kutu Pack	1	0.81 Kg	0.003
 010 092 000006	7'li Vinç Kutusu (Tek Hızlı) Crane Box, Septet (Single Speed) IP 65	1 N / A 1 N / 0 1 N / K 1 N / C	Kutu Pack	1	0.88 Kg	0.003







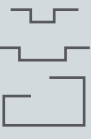

SÜPER ETANJ RAKORLAR

SUPER WATERPROOF CABLE GLANDS

	Kod Code	Açıklama Description	Kablo Çapı (min.-max.) Cable Diameter (min.-max.)	Ambalaj Packing	Adet Quantity	Ağırlık Weight	Hacim Volume
	010 097 000007	PG-7	3,0 mm - 6,5 mm	Kutu Pack	450	2.48 Kg	0.007
	010 097 000009	PG-9	4,0 mm - 8,0 mm	Kutu Pack	300	2.10 Kg	0.006
	010 097 000011	PG-11	5,0 mm - 10,0 mm	Kutu Pack	200	2 Kg	0.006
	010 097 000135	PG-13,5	6,0 mm - 12,0 mm	Kutu Pack	175	2.10 Kg	0.006
	010 097 000016	PG-16	10,0 mm - 14,0 mm	Kutu Pack	125	2.03 Kg	0.006
	010 097 000021	PG-21	13,0 mm - 18,0 mm	Kutu Pack	75	1.73 Kg	0.006
	010 097 000029	PG-29	18,0 mm - 25,0 mm	Kutu Pack	40	1.68 Kg	0.006
	010 097 000036	PG-36	22,0 mm - 32,0 mm	Kutu Pack	20	1.60 Kg	0.006
	010 097 000042	PG-42	32,0 mm - 38,0 mm	Kutu Pack	15	1.40 Kg	0.006
	010 097 000048	PG-48	34,0 mm - 44,0 mm	Kutu Pack	12	1.36 Kg	0.006



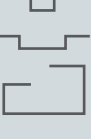

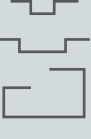

RAY KLEMENSLER

RAIL TERMINAL BLOCKS

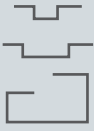
	Açıklama Description	Devre Circuit	Ambalaj Packing	Adet Quantity	Ağırlık Weight	Hacim Volume	Renk Color
 010 094 000025	2.5mm² Ray Klemens 2.5mm ² Rail Terminal Blocks Polyamid 66 Polyamide 66		Kutu Pack	100	0.75 Kg	0.002	<ul style="list-style-type: none"> ● Kırmızı / Red ● Yeşil / Green ● Sarı / Yellow ● Mavi / Blue ● Gri / Grey ● Siyah / Black
 010 094 000004	4mm² Ray Klemens 4mm ² Rail Terminal Blocks Polyamid 66 Polyamide 66		Kutu Pack	100	1.40 Kg	0.002	<ul style="list-style-type: none"> ● Kırmızı / Red ● Yeşil / Green ● Sarı / Yellow ● Mavi / Blue ● Gri / Grey ● Siyah / Black
 010 094 000006	6mm² Ray Klemens 6mm ² Rail Terminal Blocks Polyamid 66 Polyamide 66		Kutu Pack	100	1.60 Kg	0.002	<ul style="list-style-type: none"> ● Kırmızı / Red ● Yeşil / Green ● Sarı / Yellow ● Mavi / Blue ● Gri / Grey ● Siyah / Black
 010 094 000010	10mm² Ray Klemens 10mm ² Rail Terminal Blocks Polyamid 66 Polyamide 66		Kutu Pack	100	2 Kg	0.003	<ul style="list-style-type: none"> ● Kırmızı / Red ● Yeşil / Green ● Sarı / Yellow ● Mavi / Blue ● Gri / Grey ● Siyah / Black
 010 094 000016	16mm² Ray Klemens 16mm ² Rail Terminal Blocks Polyamid 66 Polyamide 66		Kutu Pack	30	0.99 Kg	0.001	<ul style="list-style-type: none"> ● Kırmızı / Red ● Yeşil / Green ● Sarı / Yellow ● Mavi / Blue ● Gri / Grey ● Siyah / Black

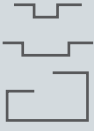
RAY KLEMENSLER

RAIL TERMINAL BLOCKS

	Açıklama Description	Devre Circuit	Ambalaj Packing	Adet Quantity	Ağırlık Weight	Hacim Volume	Renk Color
 010 094 000035	35mm² Ray Klemens 35mm ² Rail Terminal Blocks Polyamid 66 Polyamide 66		Kutu Pack	20	1.20 Kg	0.001	<ul style="list-style-type: none"> ● Kırmızı / Red ● Yeşil / Green ● Sarı / Yellow ● Mavi / Blue ● Gri / Grey ● Siyah / Black
 010 094 010001	Durdurucu Stopper Polyamid 66 Polyamide 66		Kutu Pack	100	0.90 Kg	0.002	<ul style="list-style-type: none"> ● Gri / Grey
 010 094 010006	Yazılı Dekafix Dekafix with inscriptions		Kutu Pack	-	-	-	
 010 094 010007	Yazısız Dekafix Dekafix without inscriptions		Kutu Pack	-	-	-	
	Topraklama Ray Klemensi Grounding Rail Terminal Block 010 094 010003 2,5/4 mm 010 094 010004 6/10 mm 010 094 010005 16/35 mm		Kutu Pack	-	-	-	<ul style="list-style-type: none"> ● Yeşil / Green ● Sarı / Yellow

SIKMALI TİP KABLO PAPUÇLARI (EKO SERİ)

CLAMPING TYPE CABLE TERMINAL LUGS (ECO SERIES)

	Kod Code	Açıklama Description	Ambalaj Packing	Adet Quantity	Ağırlık Weight	Hacim Volume
	123 037 000010	10 mm ²	Kutu Pack	800	2.01 Kg	0.0023
	123 037 000016	16 mm ²	Kutu Pack	500	1.68 Kg	0.0023
	123 037 000025	25 mm ²	Kutu Pack	350	1.97 Kg	0.0023
	123 037 000035	35 mm ²	Kutu Pack	200	1.33 Kg	0.0023
	123 037 000050	50 mm ²	Kutu Pack	150	1.78 Kg	0.0023
	123 037 000070	70 mm ²	Kutu Pack	100	1.73 Kg	0.0023
	123 037 000095	95 mm ²	Kutu Pack	70	1.80 Kg	0.0023
	123 037 000120	120 mm ²	Kutu Pack	50	2.04 Kg	0.0023
	123 037 000150	150 mm ²	Kutu Pack	40	1.94 Kg	0.0023
	123 037 000185	185 mm ²	Kutu Pack	30	2.00 Kg	0.0023
	123 037 000240	240 mm ²	Kutu Pack	24	2.21 Kg	0.0023

SIRA KLEMENSLER

CONNECTOR (TERMINAL BLOCKS)

	Kod Code	Açıklama Description	Ambalaj Packing	Adet Quantity	Ağırlık Weight	Hacim Volume
	015 094 160001	Zeytin Klemens No:2 (4-6mm²) Olive - Shaped Wire Connector No: 2 (4-6 mm ²)		1	0.018 Kg	0.000005
		<ul style="list-style-type: none"> ● Kırmızı / Red ● Yeşil / Green ● Sarı / Yellow ● Mavi / Blue ● Gri / Grey ● Siyah / Black 	Kutu Pack			
	015 094 150001	Plastik Sıra Klemens No:2 (2.5-4mm²) Plastic Wire Connector No: 2 (2.5-4 mm ²)	Kutu Pack	50	1.5 Kg	0.002
	015 094 150002	Plastik Sıra Klemens No:2 (4-6mm²) Plastic Wire Connector No: 2 (4-6 mm ²)	Kutu Pack	50	2.2 Kg	0.0027
	015 094 150003	Plastik Sıra Klemens No:3 (10-16mm²) Plastic Wire Connector No: 2 (10-16 mm ²)	Kutu Pack	50	3 Kg	0.0035
	015 094 150004	Plastik Sıra Klemens No:4 (16-25mm²) Plastic Wire Connector No: 2 (16-25 mm ²)	Kutu Pack	50	3.65 Kg	0.0050
	015 094 170001	Isiya Dayanıklı Sıra Klemens No:1 (2.5-4mm²) Fire-Proof Wire Connector No: 2 (2.5-4 mm ²)	Kutu Pack	50	1.6 Kg	0.002
	015 094 170002	Isiya Dayanıklı Sıra Klemens No:2 (4-6mm²) Fire-Proof Wire Connector No: 2 (4-6 mm ²)	Kutu Pack	50	2.3 Kg	0.0031
	015 094 170003	Isiya Dayanıklı Sıra Klemens No:3 (10-16mm²) Fire-Proof Wire Connector No: 2 (10-16 mm ²)	Kutu Pack	50	3.15 Kg	0.0038
	015 094 170004	Isiya Dayanıklı Sıra Klemens No:4 (16-25mm²) Fire-Proof Wire Connector No: 2 (16-25 mm ²)	Kutu Pack	50	4 Kg	0.0050

RAYLAR, TOPRAKLAMA ÇUBUĞU VE BARALAR

RAILS, GROUNDING ROD AND BUSBARS

	Kod Code	Açıklama Description	Ambalaj Packing	Adet Quantity	Ağırlık Weight	Hacim Volume
	014 094 020001	Ray Taşıyıcısı Rail Carrier	Kutu Pack	150	2.7 Kg	0.006
	001 025 020100 00 00	Klemens Rayı 1 mt. Wire Connector Rail, 1 m	Kutu Pack	25	13.38 Kg	0.006
	001 025 900100 00 00	W Otomat Rayı 1 mt. Fuse Box Rail, 1 m	Kutu Pack	50	16.5 Kg	0.013
	001 025 000033 00 00	W Otomat Rayı 33 cm. Fuse Box Rail, 33 cm	Kutu Pack	50	6.36 Kg	0.004
	001 025 900100 00 00	W Otomat Rayı (Delikli) 1 mt. Fuse Box Rail (Slotted) 1 m	Kutu Pack	50	15.75 Kg	0.013
	001 025 900099 99 00	W Otomat Rayı (Delikli) (Özel Boy) Fuse Box Rail (Slotted) (Custom Size)	Kutu Pack	1 mt.	0.315 Kg	0.00026
	034 025 040001	Topraklama Barası 1 mt. Grounding Busbar 1 m	Kutu Pack	10	3.6 Kg	0.0031
	091 025 010001	Topraklama Çubuğu 1 mt. (Piyasa) Grounding Rod 1 m (Commercial)	Kutu Pack	1	0.705 Kg	0.0001
	034 025 040004	Trif. Müşterek Bara İğne Uçlu 50 cm. Three-phase Common Busbar, Pintle Type, 50 cm.	Kutu Pack	25	6.69 Kg	0.0072
	034 025 040002	Mon. Müşterek Bara İğne Uçlu 1 mt. Three-phase Common Busbar, Pintle Type, 1 m	Kutu Pack	10	2.18 Kg	0.0020

DÖNER LAMBA, FLAŞÖRLÜ LAMBA VE SİRENLER

ROTATING BEACON, BLINKER BEACON AND SIRENS

	Kod Code	Açıklama Description	Renk Color
	888 111 050004	MS190 Mini Siren MS190 Mini Siren	
	888 111 050005	MS290P Plastik Siren 220V MS290P Plastic Siren 220V	
	888 111 050006	MS290M Metal Siren 220V MS290M Metallic Siren 220V	
	026 111 000001	Uçak İkaz Lambası (Ampullü) Aircraft Warning Light (with lamp)	
	026 111 000002	Uçak İkaz Lamba Sehpası Aircraft Warning Light Stand	
	026 111 010001	AS. 1 Motorlu Siren (Plastik Gövdeli) 220V, 150W AS. 1 Motorized Siren (Plastic Body) 220V, 150W	
	026 111 010002	AS. 2 Motorlu Siren (Plastik Gövdeli) 220V, 200W AS. 2 Motorized Siren (Plastic Body) 220V, 200W	
	026 111 010003	AS. 1 Motorlu Siren (Döküm Gövdeli) 220V, 150W AS. 1 Motorized Siren (Casting Body) 220V, 150W	
	026 111 010004	AS. 2 Motorlu Siren (Döküm Gövdeli) 220V, 200W AS. 2 Motorized Siren (Casting Body) 220V, 200W	
	001 111 020004 00 00	Döner Lamba 220 V Rotating Beacon, 220V	
	001 111 020001 00 00	Döner Lamba 12 V AC Rotating Beacon, 12 V AC	● Kırmızı / Red ● Sarı / Yellow ● Yeşil / Green ● Mavi / Blue
	001 111 020002 00 00	Döner Lamba 24 V AC Rotating Beacon, 24 V AC	● Kırmızı / Red ● Sarı / Yellow ● Yeşil / Green ● Mavi / Blue
	001 111 030001 00 00	Flaşörlü Lamba 12 V Blinker 12 V	● Kırmızı / Red ● Sarı / Yellow ● Yeşil / Green ● Mavi / Blue
	001 111 030002 00 00	Flaşörlü Lamba 24 V Blinker 24 V	● Kırmızı / Red ● Sarı / Yellow ● Yeşil / Green ● Mavi / Blue
	001 111 030003 00 00	Flaşörlü Lamba 220 V Blinker 220 V	● Kırmızı / Red ● Sarı / Yellow ● Yeşil / Green ● Mavi / Blue
	001 111 030003 00 11	Sabit Lamba 220 V AC Stationary Beacon 220 V AC	● Kırmızı / Red ● Sarı / Yellow ● Yeşil / Green ● Mavi / Blue

İKAZ LAMBALARI WARNING LIGHTS

	Kod Code	Model Models
--	-------------	-----------------

GÜNEŞ ENERJİLİ SOLAR PANEL İKAZ LAMBALARI SOLAR WARNING LIGHTS

 <p>1</p> <p>2</p> <p>3</p> <p>GÜNEŞ ENERJİLİ SOLAR İKAZ LAMBALARI</p> <p>SOLAR WARNING LIGHTS</p>	<p>1 007 087 400106 IL-XSLM-912V-TMK</p>	<p>T90 Solar İkaz Lambası ÇAKAR 12V T90 Solar Warning Lights BEACON 12 V</p>
	<p>2 007 087 400107 IL-XSL20M-TMK</p>	<p>T90 Solar Kule İkaz Lambası Seti ÇAKAR 12V T90 Solar Tower Warning Lights BEACON 12 V</p>
	<p>3 007 087 400108 IL-XSL20M-KMK</p>	<p>T90 Solar Ayaklı İkaz Lambası Seti ÇAKAR 12V T90 Solar Footed Warning Lights BEACON 12 V</p>
<ul style="list-style-type: none"> ■ Rf dalgayı yaymaz ■ Stabilize ışık çıkışı ■ 12 yıl uzun ömürlü ■ UV ışınlarına karşı dayanıklı ■ Görülebilirlik mesafesi 10 km ■ Her türlü yüzeye kolay montaj ■ Sabit, flaşör, çakar ve döner çalışma fonksiyonları ■ Foto sensör yardımıyla gece ve gündüz algılama 		<ul style="list-style-type: none"> ■ No RF radiation ■ Stabilized light output ■ 12 year long life ■ Resistant to UV rays ■ Visibility distance of 10 km ■ Easy installation on any surface ■ Continuous, flashing, strobe signal type ■ Photo help night and sensor day detection

MULTİ VE ŞARJLI İKAZ LAMBALARI CHARGEABLE WARNING LIGHTS

	<p>T90 MULTİ SERİ TEK GÖVDE DÖRT FARKLI ÇALIŞMA ÖZELLİĞİ T90 MULTI SERIES ONE BODY FEATURE FOUR DIFFERENT WORK</p>	
	<p>007 087 400101 IL-XLM-VT9-24K</p>	<p>Multi 24 VDC</p>
	<p>007 087 400102 IL-XLM-VT9-220K</p>	<p>Multi 220 VAC</p>
	<p>007 087 400103 IL-XLMB-VT9-24K</p>	<p>Multi + Buzzer 24 VAC</p>
<p>007 087 400104 IL-XLMB-VT9-220K</p>	<p>Multi + Buzzer 220 VAC</p>	
<p>T90 MULTİ SERİ TEK GÖVDE DÖRT FARKLI ÇALIŞMA ÖZELLİĞİ T90 MULTI SERIES ONE BODY FEATURE FOUR DIFFERENT WORK</p>		
<p>007 087 400105 IL-XJM-912V-TMK</p>	<p>Şarjlı, Multi + Buzzer 12 V</p>	
<ul style="list-style-type: none"> ■ Stabilize ışık çıkışı ■ Her türlü yüzeye kolay montaj ■ Sabit, flaşör, çakar ve döner çalışma fonksiyonları 		<ul style="list-style-type: none"> ■ Stabilized light output ■ Easy installation on any surface ■ Continuous, flashing, strobe signal type

Renk Seçenekleri
Color Options



Temperature



High IP value



Shock /
Vibration
resistant



Magnetic
field proof



Power
LED Light

İKAZ LAMBALARI

WARNING LIGHTS

	Kod Code	Model Models
VT6 SERİSİ TEK GÖVDEDE 5 RENK İKAZ LAMBALARI VT6 SERIES ONE BODY 5 COLOR WARNING LIGHTS		
<div data-bbox="181 553 394 649"> <p>TEK GÖVDEDE 5 RENK</p>  <p>ONE BODY 5 COLORS</p> </div> <div data-bbox="475 553 613 691">  </div> <div data-bbox="620 544 771 686"> <p>ÖZEL TASARIM ALÜMİNYUM GÖVDEDE POWER LED SPECIAL DESIGN ALUMINIUM BODY POWER LED</p> </div> <div data-bbox="305 799 626 1219">  </div>	129 087 000431 IL-XPS-VT6-243-A2	Sabit Işıklı 24 VDC With Stationary Light 24 VAC
	129 087 000432 IL-XPS-VT6-2203-A2	Sabit Işıklı 220 VAC With Stationary Light 220 VAC
	129 087 000433 IL-XPF-VT6-243-A2	Flaşörlü 24 VDC With Blinker 24 VDC
	129 087 000434 IL-XPF-VT6-2203-A2	Flaşörlü 220 VAC With Blinker 220 VDC
	129 087 000435 IL-XPÇ-VT6-243-A2	Çakar 24 VDC Beacon 24 VDC
	129 087 000436 IL-XPÇ-VT6-2203-A2	Çakar 220 VAC Beacon 220 VAC
	129 087 000412 IL-XPSB-VT6-243-A2	Sabit Işıklı + Buzzer 24 VDC With Stationary Light + Buzzer 24 VDC
	129 087 000413 IL-XPSB-VT6-2203-A2	Sabit Işıklı + Buzzer 220 VAC With Stationary Light + Buzzer 220 VAC
	129 087 000414 IL-XPFB-VT6-243-A2	Flaşörlü + Buzzer 24 VDC With Blinker + Buzzer 24 VDC
	129 087 000415 IL-XPFB-VT6-2203-A2	Flaşörlü + Buzzer 220 VAC With Blinker + Buzzer 220 VDC
	129 087 000416 IL-XPÇB-VT6-243-A2	Çakar + Buzzer 24 VDC Beacon + Buzzer 24 VDC
	129 087 000417 IL-XPÇB-VT6-2203-A2	Çakar + Buzzer 220 VAC Beacon + Buzzer 220 VAC
	129 087 000418 IL-XM125	Güç Konnektörü Power Connector

F7 SERİSİ 12-80 VDC MOBİL UYGULAMA İÇİN İKAZ LAMBALARI

ORANGE JUNCTION BOXES AND CASINGS

<p>GENİŞ ÇALIŞMA AKIMI 12 VDC - 80 VDC EXTENSIVE WORK FLOW 12 VDC - 80 VDC</p> <div data-bbox="250 1552 599 2015">  </div>	129 087 000419 IL-XS-F7-80-A2	Sabit Işıklı 12-80 VDC With Stationary Light 12-80 VAC
	129 087 000420 IL-XS-F7-220-A2	Sabit Işıklı 220 VAC With Stationary Light 220 VAC
	129 087 000421 IL-XF-F7-80-A2	Flaşörlü 12-80 VDC With Blinker 12-80 VDC
	129 087 000422 IL-XF-F7-220-A2	Flaşörlü 220 VAC With Blinker 220 VDC
	129 087 000423 IL-XÇ-F7-80-A2	Çakar 12-80 VDC Beacon 12-80 VDC
	129 087 000424 IL-XÇ-F7-220-A2	Çakar 220 VAC Beacon 220 VAC
	129 087 000425 IL-XSB-F7-80-A2	Sabit Işıklı + Buzzer 12-80 VDC With Stationary Light + Buzzer 12-80 VDC
	129 087 000426 IL-XSB-F7-220-A2	Sabit Işıklı + Buzzer 220 VAC With Stationary Light + Buzzer 220 VAC
	129 087 000427 IL-XFB-F7-80-A2	Flaşörlü + Buzzer 12-80 VDC With Blinker + Buzzer 12-80 VDC
	129 087 000428 IL-XFB-F7-220-A2	Flaşörlü + Buzzer 220 VAC With Blinker + Buzzer 220 VDC
	129 087 000429 IL-XÇB-F7-80-A2	Çakar + Buzzer 12-80 VDC Beacon + Buzzer 12-80 VDC
	129 087 000430 IL-XÇB-F7-220-A2	Çakar + Buzzer 220 VAC Beacon + Buzzer 220 VAC

İKAZ LAMBALARI (TABANA MONTAJ)

WARNING LIGHTS (FLOOR-MOUNTED)

	Kod Code	Model Models	Voltaj Voltage	Tüketim Consumptive	Ampul Lamp	Çap Diameter	Montaj Assembly
 Lens	129 087 000015	IL-XM67S-24	24 VAC/DC	0.9A	24 VAC/DC	67 mm	Tabana Montaj Floor Mounted
	129 087 000018	IL-XM67S-220	220 VAC	0.9A	220 VAC	67 mm	Tabana Montaj Floor Mounted
 Lens	129 087 000020	IL-XM67F-24	24 VAC/DC	0.9A	24 VAC/DC	67 mm	Tabana Montaj Floor Mounted
	129 087 000023	IL-XM67F-220	220 VAC	0.9A	220 VAC	67 mm	Tabana Montaj Floor Mounted
 Lens	129 087 000025	IL-XM67Ç-24	24 VAC/DC	0.9A	24 VAC/DC	67 mm	Tabana Montaj Floor Mounted
	129 087 000028	IL-XM67Ç-220	220 VAC	0.9A	220 VAC	67 mm	Tabana Montaj Floor Mounted
 IL-X...-VT8 Serisi	129 087 000040	IL-XLS-VT6-24K	24V DC	0.5A	24V 5W	60 mm	Tabana Montaj Floor Mounted
	129 087 000041	IL-XLS-VT6-220K	220V AC	0.05A	220V 5W	60 mm	Tabana Montaj Floor Mounted
 IL-X...-VT8 Serisi	129 087 000043	IL-XLF-VT6-24K	24V DC	0.5A	24V 5W	60 mm	Tabana Montaj Floor Mounted
	129 087 000044	IL-XLF-VT6-220K	220V AC	0.05A	220V 5W	60 mm	Tabana Montaj Floor Mounted
 IL-X...-VT8 Serisi	129 087 000046	IL-XÇ-VT6-24K	220V AC	0.05A	220V 5W	60 mm	Tabana Montaj Floor Mounted
	129 087 000047	IL-XÇ-VT6-220K	220V AC	0.05A	220V 5W	60 mm	Tabana Montaj Floor Mounted
 IL-X...-VT8 Serisi	129 087 000050	IL-XLD-VT6-24K	24V DC	0.5A	24V 5W	60 mm	Tabana Montaj Floor Mounted
	129 087 000051	IL-XLD-VT6-220K	220V AC	0.05A	220V 5W	60 mm	Tabana Montaj Floor Mounted

Renk Seçenekleri / Color Options: K ● S ● Y ● M ● B ●



İKAZ LAMBALARI (TABANA MONTAJ)





WARNING LIGHTS (FLOOR-MOUNTED)

	Kod Code	Model Models	Voltaj Voltage	Tüketim Consumptive	Ampul Lamp	Çap Diameter	Montaj Assembly	
 IL-X...-VT8 Serisi	129 087 000053	IL-XLSB-VT6-24K	Sabit Işıklı + Buzzer With Stationary Light + Buzzer	24V DC	0.5A	24V 5W	60 mm	Tabana Montaj Floor Mounted
	129 087 000054	IL-XLSB-VT6-220K	Sabit Işıklı + Buzzer With Stationary Light + Buzzer	220V AC	0.05A	220V 5W	60 mm	Tabana Montaj Floor Mounted
 IL-X...-VT8 Serisi	129 087 000056	IL-XLFB-VT6-24K	Flaşörlü + Buzzer With Blinker + Buzzer	24V DC	0.5A	24V 5W	60 mm	Tabana Montaj Floor Mounted
	129 087 000057	IL-XLFB-VT6-220K	Flaşörlü + Buzzer With Blinker + Buzzer	220V AC	0.05A	220V 5W	60 mm	Tabana Montaj Floor Mounted

İKAZ LAMBALARI (VİDA BAĞLANTILI)

WARNING LIGHTS (SCREW CONNECTION)

	Kod Code	Model Models	Voltaj Voltage	Tüketim Consumptive	Ampul Lamp	Çap Diameter	Montaj Assembly	
 IL-X...-VT8 Serisi	129 087 000059	IL-XÇB-VT6-24K	Çakar + Buzzer Beacon + Buzzer	24 VAC/DC	0.9A	24 VAC/DC	84 mm	Vida Bağlantı Screw Connection
	129 087 000060	IL-XÇB-VT6-220K	Çakar + Buzzer Beacon + Buzzer	48 VAC/DC	0.9A	48 VAC/DC	84 mm	Vida Bağlantı Screw Connection
	129 087 000062	IL-XLDB-VT6-24K	Ledli Döner + Buzzer Rotary with LED + Buzzer	24 VAC/DC	0.9A	24 VAC/DC	84 mm	Vida Bağlantı Screw Connection
	129 087 000063	IL-XLDB-VT6-220K	Ledli Döner + Buzzer Rotary with LED + Buzzer	48 VAC/DC	0.9A	48 VAC/DC	84 mm	Vida Bağlantı Screw Connection
 	129 087 000065	IL-XLS-V8-24K	Sabit Işıklı With Stationary Light	24V DC	0.5A	24V 5W	84 mm	Vida Bağlantı Screw Connection
	129 087 000066	IL-XLS-V8-220K	Sabit Işıklı With Stationary Light	220V AC	0.05A	220V 5W	84 mm	Vida Bağlantı Screw Connection
	129 087 000068	IL-XLF-V8-24K	Flaşörlü With Blinker	24V DC	0.5A	24V 5W	84 mm	Vida Bağlantı Screw Connection
	129 087 000069	IL-XLF-V8-220K	Flaşörlü With Blinker	220V AC	0.05A	220V 5W	84 mm	Vida Bağlantı Screw Connection
	129 087 000071	IL-XÇ-V8-24K	Çakar Beacon	24V DC	0.5A	24V 5W	84 mm	Vida Bağlantı Screw Connection
	129 087 000072	IL-XÇ-V8-220K	Çakar Beacon	220V AC	0.05A	220V 5W	84 mm	Vida Bağlantı Screw Connection
	129 087 000075	IL-XLD-V8-24K	Ledli Döner Rotary With LED	24V DC	0.5A	24V 5W	84 mm	Vida Bağlantı Screw Connection
	129 087 000076	IL-XLD-V8-220K	Ledli Döner Rotary With LED	220V AC	0.05A	220V 5W	84 mm	Vida Bağlantı Screw Connection

Renk Seçenekleri / Color Options: IL-XLS-V8-12K  IL-XLS-V8-12S  IIL-XLS-V8-12Y  IL-XLS-V8-12M  IL-XLS-V8-12B 

İKAZ LAMBALARI (VİDA BAĞLANTILI)

WARNING LIGHTS (SCREW CONNECTION)

	Kod Code	Model Models	Voltaj Voltage	Tüketim Consumptive	Ampul Lamp	Çap Diameter	Montaj Assembly
	129 087 000078 IL-XLSB-V8-24K	Sabit Işıklı + Buzzer With Stationary Light + Buzzer	24V DC	0.5A	24V 5W	84 mm	Vida Bağlantı Screw Connection
	129 087 000079 IL-XLSB-V8-220K	Sabit Işıklı + Buzzer With Stationary Light + Buzzer	220V AC	0.05A	220V 5W	84 mm	Vida Bağlantı Screw Connection
	129 087 000081 IL-XLFB-V8-24K	Flaşörlü + Buzzer With Blinker + Buzzer	24V DC	0.5A	24V 5W	84 mm	Vida Bağlantı Screw Connection
	129 087 000082 IL-XLFB-V8-220K	Flaşörlü + Buzzer With Blinker + Buzzer	220V AC	0.05A	220V 5W	84 mm	Vida Bağlantı Screw Connection
	129 087 000084 IL-XÇB-V8-24K	Çakar + Buzzer Beacon + Buzzer	24 VAC/DC	0.9A	24 VAC/DC	84 mm	Vida Bağlantı Screw Connection
	129 087 000085 IL-XÇB-V8-220K	Çakar + Buzzer Beacon + Buzzer	48 VAC/DC	0.9A	48 VAC/DC	84 mm	Vida Bağlantı Screw Connection
	129 087 000087 IL-XLDB-V8-24K	Ledli Döner + Buzzer Rotary with LED + Buzzer	24 VAC/DC	0.9A	24 VAC/DC	84 mm	Vida Bağlantı Screw Connection
	129 087 000088 IL-XLDB-V8-220K	Ledli Döner + Buzzer Rotary with LED + Buzzer	48 VAC/DC	0.9A	48 VAC/DC	84 mm	Vida Bağlantı Screw Connection
	129 087 000090 IL-XLS-T8-24K	Sabit Işıklı With Stationary Light	24V DC	0.5A	24V 5W	84 mm	Tabana Montaj Floor-mounted
	129 087 000091 IL-XLS-T8-220K	Sabit Işıklı With Stationary Light	220V AC	0.05A	220V 5W	84 mm	Tabana Montaj Floor-mounted
	129 087 000093 IL-XLF-T8-24K	Flaşörlü With Blinker	24V DC	0.5A	24V 5W	84 mm	Tabana Montaj Floor-mounted
	129 087 000094 IL-XLF-T8-220K	Flaşörlü With Blinker	220V AC	0.05A	220V 5W	84 mm	Tabana Montaj Floor-mounted
	129 087 000096 IL-XÇ-T8-24K	Çakar Beacon	220V AC	0.05A	220V 5W	84 mm	Tabana Montaj Floor-mounted
	129 087 000097 IL-XÇ-T8-220K	Çakar Beacon	220V AC	0.05A	220V 5W	84 mm	Tabana Montaj Floor-mounted
	129 087 000100 IL-XLD-T8-24K	Ledli Döner Rotary With LED	24V DC	0.5A	24V 5W	84 mm	Tabana Montaj Floor-mounted
	129 087 000101 IL-XLD-T8-220K	Ledli Döner Rotary With LED	220V AC	0.05A	220V 5W	84 mm	Tabana Montaj Floor-mounted
	129 087 000103 IL-XLSB-T8-24K	Sabit Işıklı + Buzzer With Stationary Light + Buzzer	24V DC	0.5A	24V 5W	84 mm	Tabana Montaj Floor-mounted
	129 087 000104 IL-XLSB-T8-220K	Sabit Işıklı + Buzzer With Stationary Light + Buzzer	220V AC	0.05A	220V 5W	84 mm	Tabana Montaj Floor-mounted
	129 087 000106 IL-XLFB-T8-24K	Flaşörlü + Buzzer With Blinker + Buzzer	24V DC	0.5A	24V 5W	84 mm	Tabana Montaj Floor-mounted
	129 087 000107 IL-XLFB-T8-220K	Flaşörlü + Buzzer With Blinker + Buzzer	220V AC	0.05A	220V 5W	84 mm	Tabana Montaj Floor-mounted

Renk Seçenekleri / Color Options: K ● S ● Y ● M ● B ○



İKAZ LAMBALARI (VİDA BAĞLANTILI)





WARNING LIGHTS (SCREW CONNECTION)

Kod Code	Model Models	Voltaj Voltage	Tüketim Consumptive	Ampul Lamp	Çap Diameter	Montaj Assembly	
	129 087 000109 IL-XÇB-T8-24K	Çakar + Buzzer Beacon + Buzzer	24 VAC/DC	0.9A	24 VAC/DC	84 mm	Tabana Montaj Floor-mounted
	129 087 000110 IL-XÇB-T8-220K	Çakar + Buzzer Beacon + Buzzer	48 VAC/DC	0.9A	48 VAC/DC	84 mm	Tabana Montaj Floor-mounted
	129 087 000112 IL-XLDB-T8-24K	Ledli Döner + Buzzer Rotary with LED + Buzzer	24 VAC/DC	0.9A	24 VAC/DC	84 mm	Tabana Montaj Floor-mounted
	129 087 000113 IL-XLDB-T8-220K	Ledli Döner + Buzzer Rotary with LED + Buzzer	48 VAC/DC	0.9A	48 VAC/DC	84 mm	Tabana Montaj Floor-mounted

İKAZ LAMBALARI (TABANA MONTAJ)

WARNING LIGHTS (FLOOR-MOUNTED)

Kod Code	Model Models	Voltaj Voltage	Tüketim Consumptive	Ampul Lamp	Çap Diameter	Montaj Assembly	
 	129 087 000115 IL-XLS-VT8-24K	Sabit Işıklı With Stationary Light	24V DC	0.5A	24V 5W	84 mm	Tabana Montaj Floor-mounted
	129 087 000116 IL-XLS-VT8-220K	Sabit Işıklı With Stationary Light	220V AC	0.05A	220V 5W	84 mm	Tabana Montaj Floor-mounted
	129 087 000118 IL-XLF-VT8-24K	Flaşörlü With Blinker	24V DC	0.5A	24V 5W	84 mm	Tabana Montaj Floor-mounted
	129 087 000119 IL-XLF-VT8-220K	Flaşörlü With Blinker	220V AC	0.05A	220V 5W	84 mm	Tabana Montaj Floor-mounted
	129 087 000121 IL-XÇ-VT8-24K	Çakar Beacon	24V DC	0.5A	24V 5W	84 mm	Tabana Montaj Floor-mounted
	129 087 000122 IL-XÇ-VT8-220K	Çakar Beacon	220V AC	0.05A	220V 5W	84 mm	Tabana Montaj Floor-mounted
	129 087 000125 IL-XLD-VT8-24K	Ledli Döner Rotary With LED	24V DC	0.5A	24V 5W	84 mm	Tabana Montaj Floor-mounted
	129 087 000126 IL-XLD-VT8-220K	Ledli Döner Rotary With LED	220V AC	0.05A	220V 5W	84 mm	Tabana Montaj Floor-mounted
	129 087 000128 IL-XLSB-VT8-24K	Sabit Işıklı+Buzzer With Stationary Light + Buzzer	24V DC	0.5A	24V 5W	84 mm	Tabana Montaj Floor-mounted
	129 087 000129 IL-XLSB-VT8-220K	Sabit Işıklı+Buzzer With Stationary Light + Buzzer	220V AC	0.05A	220V 5W	84 mm	Tabana Montaj Floor-mounted
	129 087 000131 IL-XLFB-VT8-24K	Flaşörlü+Buzzer With Blinker + Buzzer	24V DC	0.5A	24V 5W	84 mm	Tabana Montaj Floor-mounted
	129 087 000132 IL-XLFB-VT8-220K	Flaşörlü+Buzzer With Blinker + Buzzer	220V AC	0.05A	220V 5W	84 mm	Tabana Montaj Floor-mounted
	129 087 000134 IL-XÇB-VT8-24K	Çakar + Buzzer Beacon + Buzzer	24 VAC/DC	0.9A	24 VAC/DC	84 mm	Tabana Montaj Floor-mounted
	129 087 000135 IL-XÇB-VT8-220K	Çakar + Buzzer Beacon + Buzzer	48 VAC/DC	0.9A	48 VAC/DC	84 mm	Tabana Montaj Floor-mounted
	129 087 000137 IL-XLDB-VT8-24K	Ledli Döner + Buzzer Rotary with LED + Buzzer	24 VAC/DC	0.9A	24 VAC/DC	84 mm	Tabana Montaj Floor-mounted
	129 087 000138 IL-XLDB-VT8-220K	Ledli Döner + Buzzer Rotary with LED + Buzzer	48 VAC/DC	0.9A	48 VAC/DC	84 mm	Tabana Montaj Floor-mounted

Renk Seçenekleri / Color Options: K  S  Y  M  B 

İKAZ LAMBALARI (TABANA MONTAJ)

WARNING LIGHTS (FLOOR-MOUNTED)





	Kod Code	Model Models	Voltaj Voltage	Tüketim Consumptive	Ampul Lamp	Çap Diameter	Montaj Assembly
 IL-X...-VT10 Serisi	129 087 000140	IL-XLS-VT10-24K Sabit Işıklı With Stationary Light	24V DC	0.5A	24V 5W	100 mm	Tabana Montaj Floor-mounted
	129 087 000141	IL-XLS-VT10-220K Sabit Işıklı With Stationary Light	220V AC	0.05A	220V 5W	100 mm	Tabana Montaj Floor-mounted
	129 087 000143	IL-XLF-VT10-24K Flaşörlü With Blinker	24V DC	0.5A	24V 5W	100 mm	Tabana Montaj Floor-mounted
	129 087 000144	IL-XLF-VT10-220K Flaşörlü With Blinker	220V AC	0.05A	220V 5W	100 mm	Tabana Montaj Floor-mounted
	129 087 000146	IL-XÇ-VT10-24K Çakar Beacon	220V AC	0.05A	220V 5W	100 mm	Tabana Montaj Floor-mounted
	129 087 000147	IL-XÇ-VT10-220K Çakar Beacon	220V AC	0.05A	220V 5W	100 mm	Tabana Montaj Floor-mounted
 IL-X...-VT10 Serisi	129 087 000150	IL-XLD-VT10-24K Ledli Döner Rotary With LED	24V DC	0.5A	24V 5W	100 mm	Tabana Montaj Floor-mounted
	129 087 000151	IL-XLD-VT10-220K Ledli Döner Rotary With LED	220V AC	0.05A	220V 5W	100 mm	Tabana Montaj Floor-mounted
	129 087 000153	IL-XLSB-VT10-24K Sabit Işıklı + Buzzer With Stationary Light + Buzzer	24V DC	0.5A	24V 5W	100 mm	Tabana Montaj Floor-mounted
	129 087 000154	IL-XLSB-VT10-220K Sabit Işıklı + Buzzer With Stationary Light + Buzzer	220V AC	0.05A	220V 5W	100 mm	Tabana Montaj Floor-mounted
	129 087 000156	IL-XLFB-VT10-24K Flaşörlü + Buzzer With Blinker + Buzzer	24V DC	0.5A	24V 5W	100 mm	Tabana Montaj Floor-mounted
	129 087 000157	IL-XLFB-VT10-220K Flaşörlü + Buzzer With Blinker + Buzzer	220V AC	0.05A	220V 5W	100 mm	Tabana Montaj Floor-mounted
 IL-X...-VT10 Serisi	129 087 000159	IL-XÇB-VT10-24K Çakar + Buzzer Beacon + Buzzer	24 VAC/DC	0.9A	24 VAC/DC	100 mm	Tabana Montaj Floor-mounted
	129 087 000160	IL-XÇB-VT10-220K Çakar + Buzzer Beacon + Buzzer	48 VAC/DC	0.9A	48 VAC/DC	100 mm	Tabana Montaj Floor-mounted
	129 087 000162	IL-XLDB-VT10-24K Ledli Döner + Buzzer Rotary with LED + Buzzer	24 VAC/DC	0.9A	24 VAC/DC	100 mm	Tabana Montaj Floor-mounted
	129 087 000163	IL-XLDB-VT10-220K Ledli Döner + Buzzer Rotary with LED + Buzzer	48 VAC/DC	0.9A	48 VAC/DC	100 mm	Tabana Montaj Floor-mounted

Renk Seçenekleri / Color Options: K ● S ● Y ● M ● B ○

İKAZ LAMBALARI (TABANA MONTAJ)

WARNING LIGHTS (FLOOR-MOUNTED)

	Kod Code	Model Models	Voltaj Voltage	Tüketim Consumptive	Ampul Lamp	Çap Diameter	Montaj Assembly
 IL-X...-VT10 Serisi	129 087 000165	IL-XLS-VT12-24K	24V DC	0.5A	24V 5W	120 mm	Tabana Montaj Floor-mounted
	129 087 000166	IL-XLS-VT12-220K	220V AC	0.05A	220V 5W	120 mm	Tabana Montaj Floor-mounted
	129 087 000168	IL-XLF-VT12-24K	24V DC	0.5A	24V 5W	120 mm	Tabana Montaj Floor-mounted
	129 087 000169	IL-XLF-VT12-220K	220V AC	0.05A	220V 5W	120 mm	Tabana Montaj Floor-mounted
	129 087 000171	IL-XÇ-VT12-24K	24V DC	0.5A	24V 5W	120 mm	Tabana Montaj Floor-mounted
	129 087 000172	IL-XÇ-VT12-220K	220V AC	0.05A	220V 5W	120 mm	Tabana Montaj Floor-mounted
 IL-X...-VT10 Serisi	129 087 000175	IL-XLD-VT12-24K	24V DC	0.5A	24V 5W	120 mm	Tabana Montaj Floor-mounted
	129 087 000176	IL-XLD-VT12-220K	220V AC	0.05A	220V 5W	120 mm	Tabana Montaj Floor-mounted
	129 087 000178	IL-XLSB-VT12-24K	24V DC	0.5A	24V 5W	120 mm	Tabana Montaj Floor-mounted
	129 087 000179	IL-XLSB-VT12-220K	220V AC	0.05A	220V 5W	120 mm	Tabana Montaj Floor-mounted
	129 087 000181	IL-XLFB-VT12-24K	24V DC	0.5A	24V 5W	120 mm	Tabana Montaj Floor-mounted
	129 087 000182	IL-XLFB-VT12-220K	220V AC	0.05A	220V 5W	120 mm	Tabana Montaj Floor-mounted
 IL-X...-VT10 Serisi	129 087 000184	IL-XÇB-VT12-24K	24 VAC/DC	0.9A	24 VAC/DC	120 mm	Tabana Montaj Floor-mounted
	129 087 000185	IL-XÇB-VT12-220K	48 VAC/DC	0.9A	48 VAC/DC	120 mm	Tabana Montaj Floor-mounted
	129 087 000187	IL-XLDB-VT12-24K	24 VAC/DC	0.9A	24 VAC/DC	120 mm	Tabana Montaj Floor-mounted
	129 087 000188	IL-XLDB-VT12-220K	48 VAC/DC	0.9A	48 VAC/DC	120 mm	Tabana Montaj Floor-mounted

Renk Seçenekleri / Color Options: K  S  Y  M  B 

1 KATLI IŞIKLI KOLONLAR

1-STOREY ILLUMINATED COLUMNS



	Kod Code	Model Models	Voltaj Voltage	Tüketim Consumptive	Ampul Lamp	Çap Diameter	Montaj Assembly
 <p>IL-X...T5 Serisi</p>	129 087 000278	IL-XLS-T5-241	24 V	0.9A	24 VAC/DC	52 mm	Tabana Montaj Floor-mounted
	129 087 000279	IL-XLS-T5-2201	24 V	0.9A	24 VAC/DC	52 mm	Tabana Montaj Floor-mounted
	129 087 000281	IL-XLF-T5-241	48 V	0.9A	48 VAC/DC	52 mm	Tabana Montaj Floor-mounted
	129 087 000282	IL-XLF-T5-2201	48 V	0.9A	48 VAC/DC	52 mm	Tabana Montaj Floor-mounted
	129 087 000284	IL-XÇ-T5-241	24 V	0.9A	24 VAC/DC	52 mm	Tabana Montaj Floor-mounted
	129 087 000285	IL-XÇ-T5-2201	48 V	0.9A	48 VAC/DC	52 mm	Tabana Montaj Floor-mounted
 <p>IL-X...T5 Buzzer Serisi</p>	129 087 000287	IL-XLSB-T5-241	24 V	0.9A	24 VAC/DC	52 mm	Tabana Montaj Floor-mounted
	129 087 000288	IL-XLSB-T5-2201	48 V	0.9A	48 VAC/DC	52 mm	Tabana Montaj Floor-mounted
	129 087 000290	IL-XLFB-T5-241	24 V	0.9A	24 VAC/DC	52 mm	Tabana Montaj Floor-mounted
	129 087 000291	IL-XLFB-T5-2201	48 V	0.9A	48 VAC/DC	52 mm	Tabana Montaj Floor-mounted
	129 087 000293	IL-XÇB-T5-241	24 V	0.9A	24 VAC/DC	52 mm	Tabana Montaj Floor-mounted
	129 087 000294	IL-XÇB-T5-2201	48 V	0.9A	48 VAC/DC	52 mm	Tabana Montaj Floor-mounted

Renk Seçenekleri / Color Options: K ● S ● Y ● M ● B ○

2 ve 3 KATLI IŞIKLI KOLONLAR

2 and 3 STOREY ILLUMINATED COLUMNS

	Kod Code	Model Models	Voltaj Voltage	Tüketim Consumptive	Ampul Lamp	Çap Diameter	Montaj Assembly
	129 087 000296 IL-XLS-T5-242	Sabit Işıklı With Stationary Light	24 V	0.9A	24 VAC/DC	0 mm	Tabana Montaj Floor-mounted
	129 087 000297 IL-XLS-T5-2202	Sabit Işıklı With Stationary Light	48 V	0.9A	48 VAC/DC	0 mm	Tabana Montaj Floor-mounted
IL-X...-T5 Serisi	129 087 000299 IL-XLF-T5-242	Flaşörlü With Blinker	24 V	0.9A	24 VAC/DC	52 mm	Tabana Montaj Floor-mounted
	129 087 000300 IL-XLF-T5-2202	Flaşörlü With Blinker	48 V	0.9A	48 VAC/DC	52 mm	Tabana Montaj Floor-mounted
	129 087 000302 IL-XLSB-T5-242	Sabit Işıklı + Buzzer With Stationary Light + Buzzer	24 V	0.9A	24 VAC/DC	52 mm	Tabana Montaj Floor-mounted
	129 087 000303 IL-XLSB-T5-2202	Sabit Işıklı + Buzzer With Stationary Light + Buzzer	48 V	0.9A	48 VAC/DC	52 mm	Tabana Montaj Floor-mounted
IL-X...-T5 Buzzer Serisi	129 087 000305 IL-XLFB-T5-242	Flaşörlü + Buzzer With Blinker + Buzzer	24 V	0.9A	24 VAC/DC	52 mm	Tabana Montaj Floor-mounted
	129 087 000306 IL-XLFB-T5-2202	Flaşörlü + Buzzer With Blinker + Buzzer	48 V	0.9A	48 VAC/DC	52 mm	Tabana Montaj Floor-mounted
Renk Seçenekleri / Color Options: IL-XLS-T5-122 ● ●							

	129 087 000308 IL-XLS-T5-243	Sabit Işıklı With Stationary Light	24 V	0.9A	24 VAC/DC	52 mm	Tabana Montaj Floor-mounted
	129 087 000309 IL-XLS-T5-2203	Sabit Işıklı With Stationary Light	48 V	0.9A	48 VAC/DC	52 mm	Tabana Montaj Floor-mounted
IL-X...-T5 Buzzer Serisi	129 087 000311 IL-XLF-T5-243	Flaşörlü With Blinker	24 V	0.9A	24 VAC/DC	52 mm	Tabana Montaj Floor-mounted
	129 087 000312 IL-XLF-T5-2203	Flaşörlü With Blinker	48 V	0.9A	48 VAC/DC	52 mm	Tabana Montaj Floor-mounted
	129 087 000314 IL-XLSB-T5-243	Sabit Işıklı + Buzzer With Stationary Light + Buzzer	24 V	0.9A	24 VAC/DC	52 mm	Tabana Montaj Floor-mounted
	129 087 000315 IL-XLSB-T5-2203	Sabit Işıklı + Buzzer With Stationary Light + Buzzer	48 V	0.9A	48 VAC/DC	52 mm	Tabana Montaj Floor-mounted
IL-X...-T5 Serisi	129 087 000317 IL-XLFB-T5-243	Flaşörlü + Buzzer With Blinker + Buzzer	24 V	0.9A	24 VAC/DC	52 mm	Tabana Montaj Floor-mounted
	129 087 000318 IL-XLFB-T5-2203	Flaşörlü + Buzzer With Blinker + Buzzer	48 V	0.9A	48 VAC/DC	52 mm	Tabana Montaj Floor-mounted
Renk Seçenekleri / Color Options: IL-XLS-T5-123 ● ● ●							

4 ve 5 KATLI IŞIKLI KOLONLAR

4 and 5 STOREY ILLUMINATED COLUMNS

	Kod Code	Model Models	Voltaj Voltage	Tüketim Consumptive	Ampul Lamp	Çap Diameter	Montaj Assembly	
	129 087 000254 IL-XLS-T5-244	Sabit Işıklı With Stationary Light	24 V	0.9A	24 VAC/DC	52 mm	Tabana Montaj Floor-mounted	
	129 087 000255 IL-XLS-T5-2204	Sabit Işıklı With Stationary Light	48 V	0.9A	48 VAC/DC	52 mm	Tabana Montaj Floor-mounted	
	129 087 000257 IL-XLF-T5-244	Flaşörlü With Blinker	24 V	0.9A	24 VAC/DC	52 mm	Tabana Montaj Floor-mounted	
	129 087 000258 IL-XLF-T5-2204	Flaşörlü With Blinker	48 V	0.9A	48 VAC/DC	52 mm	Tabana Montaj Floor-mounted	
	129 087 000260 IL-XLSB-T5-244	Sabit Işıklı + Buzzer With Stationary Light + Buzzer	24 V	0.9A	24 VAC/DC	52 mm	Tabana Montaj Floor-mounted	
	129 087 000261 IL-XLSB-T5-2204	Sabit Işıklı + Buzzer With Stationary Light + Buzzer	48 V	0.9A	48 VAC/DC	52 mm	Tabana Montaj Floor-mounted	
	129 087 000263 IL-XLFB-T5-244	Flaşörlü + Buzzer With Blinker + Buzzer	24 V	0.9A	24 VAC/DC	52 mm	Tabana Montaj Floor-mounted	
	129 087 000264 IL-XLFB-T5-2204	Flaşörlü + Buzzer With Blinker + Buzzer	48 V	0.9A	48 VAC/DC	52 mm	Tabana Montaj Floor-mounted	
	Renk Seçenekleri / Color Options: IL-XLS-T5-124 ● ● ● ●							

	129 087 000266 IL-XLS-T5-245	Sabit Işıklı With Stationary Light	24 V	0.9A	24 VAC/DC	52 mm	Tabana Montaj Floor-mounted	
	129 087 000267 IL-XLS-T5-2205	Sabit Işıklı With Stationary Light	48 V	0.9A	48 VAC/DC	52 mm	Tabana Montaj Floor-mounted	
	129 087 000269 IL-XLF-T5-245	Sabit Işıklı With Stationary Light	24 V	0.9A	24 VAC/DC	52 mm	Tabana Montaj Floor-mounted	
	129 087 000270 IL-XLF-T5-2205	Sabit Işıklı With Stationary Light	48 V	0.9A	48 VAC/DC	52 mm	Tabana Montaj Floor-mounted	
	129 087 000272 IL-XLSB-T5-245	Sabit Işıklı + Buzzer With Stationary Light + Buzzer	24 V	0.9A	24 VAC/DC	52 mm	Tabana Montaj Floor-mounted	
	129 087 000273 IL-XLSB-T5-2205	Sabit Işıklı + Buzzer With Stationary Light + Buzzer	48 V	0.9A	48 VAC/DC	52 mm	Tabana Montaj Floor-mounted	
	129 087 000275 IL-XLFB-T5-245	Flaşörlü + Buzzer With Blinker + Buzzer	24 V	0.9A	24 VAC/DC	52 mm	Tabana Montaj Floor-mounted	
	129 087 000276 IL-XLFB-T5-2205	Flaşörlü + Buzzer With Blinker + Buzzer	48 V	0.9A	48 VAC/DC	52 mm	Tabana Montaj Floor-mounted	
	Renk Seçenekleri / Color Options: IL-XLS-T5-125 ● ● ● ●							

KORNALAR

HORNS

	Kod Code	Model Models	Voltaj Voltage	Ses Seviyesi Decibel	Çap Diameter	Çalışma Şekli Mode Operation	Montaj Assembly	
	129 087 000230	IL-XB-B-24	24V	95dB/30 cm	67 mm	Kesik Kesik Intermittent		
	129 087 000233	IL-XB-B-220	220V	95dB/30 cm	67 mm	Kesik Kesik Intermittent		
	129 087 000235	IL-XB-Q-24	24V	95dB/30 cm	67 mm	Kesik Kesik Intermittent		
	129 087 000238	IL-XB-Q-220	220V	95dB/30 cm	67 mm	Kesik Kesik Intermittent		
	129 087 000245	IL-XFM-12A-905AL70	12V	90dB/30 cm	52 mm	Çift Ses Dual Sound	Kablolu Wired	
	129 087 000246	IL-XFM-12Q-905L70	12V	95dB/60 cm	52 mm	Çift Ses Dual Sound	Kablolu Wired	
	129 087 000247	IL-XFM-24C-905L70	24V	92dB/100 cm	52 mm	Çift Ses Dual Sound	Kablolu Wired	
	129 087 000248	IL-XFM-220A-905AL70	220V	95dB/30 cm	52 mm	Çift Ses Dual Sound	Kablolu Wired	
	129 087 000249	IL-XFM-24C-900L700	24V	92dB/100 cm	52 mm	Sürekli Sesli Continuous Voice	Kablolu Wired	
		129 087 000250	IL-XFM-220A-905A	12V	90dB/300 cm	52 mm	Çift Ses Dual Sound	Kablolu Wired
		129 087 000251	IL-XFM-12A-905A	220V	90dB/30 cm	52 mm	Çift Ses Dual Sound	Kablolu Wired
129 087 000252		IL-XFM-12Q-905	12V	90dB/30 cm	52 mm	Çift Ses Dual Sound	Kablolu Wired	

TERMOPLASTİK BUATLAR

THERMOPLASTIC JUNCTION BOXES

	Kod Code	Açıklama Description	Ambalaj Packing	Adet Quantity	Ağırlık Weight	Hacim Volume
	Alev Yaymayan Non Flammable   CE 001 046 090090 00 17	Ø 90 Termoplastik Buat Ø 90 Thermoplastic Junction Box IP40	Kutu Pack	216	12.28 Kg	0.091
	Alev Yayan Flammable 001 046 070090 00 17					
	Alev Yaymayan Non Flammable   CE 001 046 098585 00 17	85x85x48 Termoplastik Buat 85x85x48 Thermoplastic Junction Box IP40	Kutu Pack	216	21.15 Kg	0.098
	Alev Yayan Flammable 001 046 078585 00 17					
	Alev Yaymayan Non Flammable   CE 001 046 098080 00 17	80x80x48 Termoplastik 7 Çıkışlı Buat 80x80x48 Thermoplastic Junction Box with 7 outlets IP40	Kutu Pack	216	15.62 Kg	0.091
	Alev Yayan Flammable 001 046 078080 00 17					
	Alev Yaymayan Non Flammable   CE 001 046 091010 00 17	110x110x74 Termoplastik 8 Çıkışlı Buat 110x110x74 Thermoplastic Junction Box with 8 outlets IP65	Kutu Pack	90	18.22 Kg	0.140
	Alev Yayan Flammable 001 046 071010 00 17					
	Alev Yaymayan Non Flammable   CE 001 046 091118 00 17	110x180x77 Termoplastik 10 Çıkışlı Buat 110x180x77 Thermoplastic Junction Box with 10 outlets IP65	Kutu Pack	60	18.02 Kg	0.112
	Alev Yayan Flammable 001 046 071118 00 17					
	Alev Yaymayan Non Flammable   CE 001 046 091827 00 17	180x270x100 Termoplastik 14 Çıkışlı Buat 180x270x100 Thermoplastic Junction Box with 14 outlets IP65	Kutu Pack	20	15.82 Kg	0.137
	Alev Yayan Flammable 001 046 071827 00 17					

TERMOPLASTİK BUATLAR

THERMOPLASTIC JUNCTION BOXES

	Kod Code	Açıklama Description	Ambalaj Packing	Adet Quantity	Ağırlık Weight	Hacim Volume
	Alev Yayımayan Non Flammable   CE 001 046 092698 00 44	138x226x98 Şeffaf Termoplastik Buat 138x226x98 Transparent Thermoplastic Boxes	Kutu Pack	8	3.68 Kg	0.056
	Alev Yayan Flammable 001 046 072698 00 44	IP65				
	Alev Yayımayan Non Flammable   CE 001 046 096131 00 44	138x226x131 Şeffaf Termoplastik Buat 138x226x131 Transparent Thermoplastic Boxes	Kutu Pack	8	3.94 Kg	0.023
	Alev Yayan Flammable 001 046 076131 00 44	IP65				
	Alev Yayımayan Non Flammable   CE 001 046 091199 00 44	225x311x99 Şeffaf Termoplastik Buat 225x311x99 Transparent Thermoplastic Boxes	Kutu Pack	4	3.17 Kg	0.028
	Alev Yayan Flammable 001 046 071199 00 44	IP65				
	Alev Yayımayan Non Flammable   CE 001 046 091130 00 44	225x311x130 Şeffaf Termoplastik Buat 225x311x130 Transparent Thermoplastic Boxes	Kutu Pack	4	3.55 Kg	0.028
	Alev Yayan Flammable 001 046 071130 00 44	IP65				
	Alev Yayımayan Non Flammable   CE 001 046 092698 00 17	138x226x98 Termoplastik Buat 138x226x98 Thermoplastic Boxes	Kutu Pack	8	3.67 Kg	0.024
	Alev Yayan Flammable 001 046 072698 00 17	IP65				
	Alev Yayımayan Non Flammable   CE 001 046 096131 00 17	138x226x131 Termoplastik Buat 138x226x131 Thermoplastic Boxes	Kutu Pack	8	3.94 Kg	0.023
	Alev Yayan Flammable 001 046 076131 00 17	IP65				
	Alev Yayımayan Non Flammable   CE 001 046 091199 00 17	225x311x99 Termoplastik Buat 225x311x99 Thermoplastic Boxes	Kutu Pack	4	2.78 Kg	0.028
	Alev Yayan Flammable 001 046 071199 00 17	IP65				
	Alev Yayımayan Non Flammable   CE 001 046 091130 00 17	225x311x130 Termoplastik Buat 225x311x130 Thermoplastic Boxes	Kutu Pack	4	3.01 Kg	0.036
	Alev Yayan Flammable 001 046 071130 00 17	IP65				
	Alev Yayımayan Non Flammable   CE 001 046 098226 00 17	138x226x127 Kombinasyon Kutusu 138x226x127 Combination Box	Kutu Pack	8	4.51 Kg	0.032
	Alev Yayan Flammable 001 046 078226 00 17	IP65				
	Alev Yayımayan Non Flammable   CE 001 046 095311 00 17	225x311x132 Kombinasyon Kutusu 225x311x132 Combination Box	Kutu Pack	4	3.13 Kg	0.037
	Alev Yayan Flammable 001 046 075311 00 17	IP65				

PLASTİK OPAK KAPAKLI PANOLAR

PLASTIC PANELS WITH OPAQUE LID

	Kod Code	Açıklama Description	Ambalaj Packing	Adet Quantity	Ağırlık Weight	Hacim Volume
	048 090 203013	20X30X13	Kutu / Pack	1	1.40 Kg.	0.084
	048 090 253515	25X35X15	Kutu / Pack	1	2.20 Kg.	0.014
	048 090 304017	30X40X17	Kutu / Pack	1	3.00 Kg.	0.021
	048 090 304022	30X40X22	Kutu / Pack	1	3.20 Kg.	0.027
	048 090 355019	35X50X19	Kutu / Pack	1	4.00 Kg.	0.034
	048 090 405018	40X50X17,5	Kutu / Pack	1	4.30 Kg.	0.037
	048 090 405024	40X50X24	Kutu / Pack	1	5.00 Kg.	0.049
	048 090 406020	40X60X20	Kutu / Pack	1	5.20 Kg.	0.049
	048 090 507025	50X70X25	Kutu / Pack	1	8.30 Kg.	0.088
	048 090 608026	60x80x26	Kutu / Pack	1	9.00 Kg.	0.125

PLASTİK ŞEFFAF KAPAKLI PANOLAR





















PLASTIC PANELS WITH TRASPARENT LID

	048 088 203013	20X30X13	Kutu / Pack	1	1.50 Kg.	0.084
	048 088 253515	25X35X15	Kutu / Pack	1	2.40 Kg.	0.014
	048 088 304017	30X40X17	Kutu / Pack	1	3.20 Kg.	0.021
	048 088 304022	30X40X22	Kutu / Pack	1	3.40 Kg.	0.027
	048 088 355019	35X50X19	Kutu / Pack	1	4.20 Kg.	0.034
	048 088 405018	40X50X17,5	Kutu / Pack	1	4.60 Kg.	0.037
	048 088 405024	40X50X24	Kutu / Pack	1	5.20 Kg.	0.049
	048 088 406020	40X60X20	Kutu / Pack	1	5.40 Kg.	0.049
	048 088 507025	50X70X25	Kutu / Pack	1	8.80 Kg.	0.088
	048 088 608026	60x80x26	Kutu / Pack	1	9.50 Kg.	0.125

KARE BUATLAR

SQUARE JUNCTION BOXES

IP 40

	001 046 051010 00 12	  Alev Yaymayan 10x10 Kare Buat Turuncu Non Flammable 10x10 Square Junc Orange	Kutu Pack	10	0.833 Kg	0.0061
	001 046 021010 00 12	  Alev Yayan 10x10 Kare Buat Turuncu Flammable 10x10 Square Junc Orange	Kutu Pack	10	0.833 Kg	0.0061
	001 046 051212 00 12	  Alev Yaymayan 12x12 Kare Buat Turuncu Non Flammable 12x12 Square Junc Orange	Kutu Pack	10	1.02 Kg	0.0093
	001 046 021212 00 12	  Alev Yayan 12x12 Kare Buat Turuncu Flammable 12x12 Square Junc Orange	Kutu Pack	10	1.02 Kg	0.0093
	001 046 051515 00 12	  Alev Yaymayan 15x15 Kare Buat Turuncu Non Flammable 15x15 Square Junc Orange	Kutu Pack	10	1.85 Kg	0.0151
	001 046 021515 00 12	  Alev Yayan 15x15 Kare Buat Turuncu Flammable 15x15 Square Junc Orange	Kutu Pack	10	1.85 Kg	0.0151
	001 046 052020 00 12	  Alev Yaymayan 20x20 Kare Buat Turuncu Non Flammable 20x20 Square Junc Orange	Kutu Pack	10	2.857 Kg	0.028
	001 046 022020 00 12	  Alev Yayan 20x20 Kare Buat Turuncu Flammable 20x20 Square Junc Orange	Kutu Pack	10	2.857 Kg	0.028



TESİSAT MALZEMELERİ
INSTALLATION
MATERIALS

COMFORT W Otomat kutusu Fuse Box



- Estetik, sade, gözleri yormayan düz ve keskin hatlara sahip olan modern görsel tasarım
- 4 Vida ile sağlam kapak tesbiti
- Kolay ve pratik, arıza ihtimali olmayan açma-kapama özelliğine sahip cam
- Ip 40 koruma özelliği
- Sıva altı serisinde kolay ve tabana sıfır kırılan,
- Üstte-altta-yanda ve arkada yer alan çok sayıda kablo giriş pencereleri
- Çift taraflı (sağa ve sola) açılabilen cam
- Her iki yönde de kullanılabilen sıva altı ve sıva üstü gövdeler
- Sıva üstü gövdede arkada, altta ve üstte gizli-kolay kırılabilir kablo giriş pencereleri
- Sıva üstü serisinde pg 13-pg 16 rakor ve 21-25 mm çapta boru girişine müsait kablo giriş pencereleri
- Sıva altı serisinde max 32 mm çapta boru girişine sahip kablo giriş pencereleri
- Kablo bağlantıları için geniş iç hacim
- Mukavemetli alt ve yan duvarlar
- Sıva altı ve sıva üstü serisinde ortak kullanılabilen kapak ve cam

- Modern visual design with aesthetic, simple, flat and sharp lines
- Cover fixing with 4 screws
- Easy and practical, open-close glass with no possibility of malfunction
- Ip 40 protection feature
- Easy and zero based in flush mounted series
- Many cable entry windows on the top-bottom-side and rear
- Double-sided (right and left) opened glass
- Flush and surface-mounted bodies that can be used in both side
- Easy-to-break cable entry windows at the rear, top and bottom on surface mounted body
- Cable entry windows suitable for pipe entry of 16 gauge pg 13-pg diameter and 21-25 mm diameter in the surface mounted series
- Cable entry windows with pipe entrance of maximum 32 mm diameter in flush mounted series
- Wider internal volume for cable connections
- Strengthened bottom and side walls
- Cover and glass that can be used in flush and surface mounted series



BOYUTLAR • DIMENSIONS

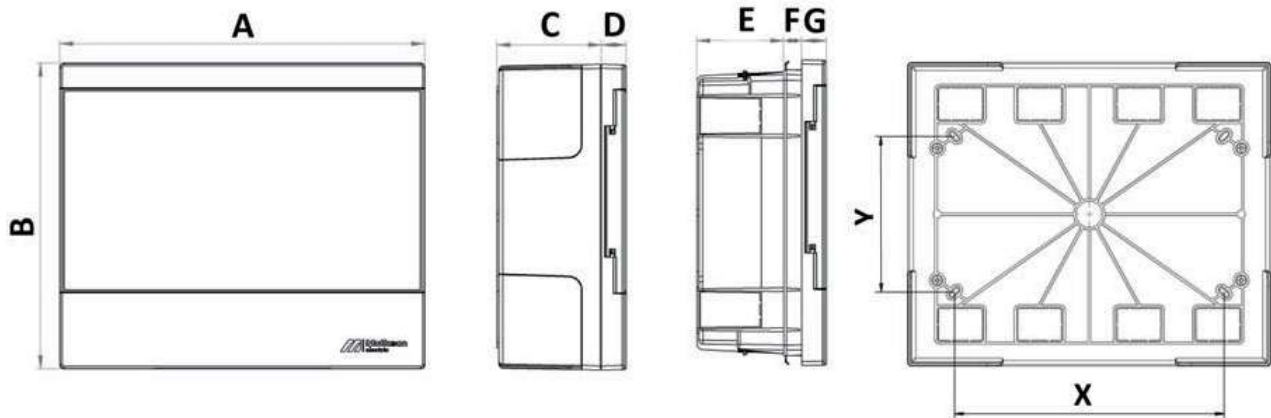

ÖLÇÜLER / SIZES	SIVA ALTI FLUSH	A	B	C	D	E	F	G	X	Y
		6	167	180			65,5	13,5	18,5	
9	221	180			65,5	13,5	18,5			
12	275	230			65,5	13,5	18,5			
18	383	230			65,5	13,5	18,5			
24	275	345			65,5	13,5	18,5			
36	275	460			65,5	13,5	18,5			
SIVA ÜSTÜ SURFACE	6	167	180	78,8	18,5				70	80
	9	221	180	78,8	18,5				133	80
12	275	230	78,8	18,5				204	118	
18	383	230	78,8	18,5				312	118	
24	275	345	78,8	18,5				204	233	
36	275	460	78,8	18,5				204	348	

Terminal koruma seviyesi(Koruma Sınıfı) : IP 40
 Kutuların tipi : Dikdörtgen kutulardır
 Tesis sırasındaki sıcaklık aralığı : -25°C / +60°C
 Yalıtım direnci : 5 MΩ' un üzerindedir
 Yüksek gerilime dayanım : 3750 V AC(alternatif akım,
 220 V /400 V ~50 Hz)

Terminal protection level (Protection class) : IP 40
 Types of boxes : Rectangular boxes
 The temperature range during installation : -25°C / +60°C
 Insulation resistance : over 5 MΩ
 High tensile resistance : 3750 V AC
 (alternative current, 220 V /400 V ~50 Hz)

COMFORT W OTOMAT KUTULARI H.FREE (ALEV YAYAN)
COMFORT FUSE BOXES H.FREE (NON FLAMMABLE)

IP40

 <p>001 057 120006 00 00 Alev Yayan Flammable </p> <p>6 'lı Sıva Üstü W Otomat Kutusu (Kapaklı) Surface-Mounted Fuse Box (With Cover), 6 Fuses</p> <table border="1"> <tr> <td>Ambalaj Şekli / Package Type</td> <td>Kutu / Pack</td> </tr> <tr> <td>Adet / m / Quantity / m</td> <td>20</td> </tr> <tr> <td>Ağırlık / Weight</td> <td>7.76 kg</td> </tr> <tr> <td>m³ / Volume</td> <td>0.058</td> </tr> </table>	Ambalaj Şekli / Package Type	Kutu / Pack	Adet / m / Quantity / m	20	Ağırlık / Weight	7.76 kg	m ³ / Volume	0.058	 <p>001 057 020006 00 00 Alev Yayan Flammable </p> <p>6 'lı Sıva Altı W Otomat Kutusu Flush-Mounted Fuse Box, 6 Fuses</p> <table border="1"> <tr> <td>Ambalaj Şekli / Package Type</td> <td>Kutu / Pack</td> </tr> <tr> <td>Adet / m / Quantity / m</td> <td>20</td> </tr> <tr> <td>Ağırlık / Weight</td> <td>7.50 kg</td> </tr> <tr> <td>m³ / Volume</td> <td>0.058</td> </tr> </table>	Ambalaj Şekli / Package Type	Kutu / Pack	Adet / m / Quantity / m	20	Ağırlık / Weight	7.50 kg	m ³ / Volume	0.058
Ambalaj Şekli / Package Type	Kutu / Pack																
Adet / m / Quantity / m	20																
Ağırlık / Weight	7.76 kg																
m ³ / Volume	0.058																
Ambalaj Şekli / Package Type	Kutu / Pack																
Adet / m / Quantity / m	20																
Ağırlık / Weight	7.50 kg																
m ³ / Volume	0.058																
 <p>001 057 120009 00 00 Alev Yayan Flammable </p> <p>9 'lu Sıva Üstü W Otomat Kutusu (Kapaklı) Surface-Mounted Fuse Box (With Cover), 9 Fuses</p> <table border="1"> <tr> <td>Ambalaj Şekli / Package Type</td> <td>Kutu / Pack</td> </tr> <tr> <td>Adet / m / Quantity / m</td> <td>20</td> </tr> <tr> <td>Ağırlık / Weight</td> <td>9.64 kg</td> </tr> <tr> <td>m³ / Volume</td> <td>0.080</td> </tr> </table>	Ambalaj Şekli / Package Type	Kutu / Pack	Adet / m / Quantity / m	20	Ağırlık / Weight	9.64 kg	m ³ / Volume	0.080	 <p>001 057 020009 00 00 Alev Yayan Flammable </p> <p>9 'lu Sıva Altı W Otomat Kutusu Flush-Mounted Fuse Box, 9 Fuses</p> <table border="1"> <tr> <td>Ambalaj Şekli / Package Type</td> <td>Kutu / Pack</td> </tr> <tr> <td>Adet / m / Quantity / m</td> <td>20</td> </tr> <tr> <td>Ağırlık / Weight</td> <td>8.60 kg</td> </tr> <tr> <td>m³ / Volume</td> <td>0.080</td> </tr> </table>	Ambalaj Şekli / Package Type	Kutu / Pack	Adet / m / Quantity / m	20	Ağırlık / Weight	8.60 kg	m ³ / Volume	0.080
Ambalaj Şekli / Package Type	Kutu / Pack																
Adet / m / Quantity / m	20																
Ağırlık / Weight	9.64 kg																
m ³ / Volume	0.080																
Ambalaj Şekli / Package Type	Kutu / Pack																
Adet / m / Quantity / m	20																
Ağırlık / Weight	8.60 kg																
m ³ / Volume	0.080																
 <p>001 057 120012 00 00 Alev Yayan Flammable </p> <p>12 'li Sıva Üstü W Otomat Kutusu (Kapaklı) Surface-Mounted Fuse Box (With Cover), 12 Fuses</p> <table border="1"> <tr> <td>Ambalaj Şekli / Package Type</td> <td>Kutu / Pack</td> </tr> <tr> <td>Adet / m / Quantity / m</td> <td>10</td> </tr> <tr> <td>Ağırlık / Weight</td> <td>6.70 kg</td> </tr> <tr> <td>m³ / Volume</td> <td>0.063</td> </tr> </table>	Ambalaj Şekli / Package Type	Kutu / Pack	Adet / m / Quantity / m	10	Ağırlık / Weight	6.70 kg	m ³ / Volume	0.063	 <p>001 057 020012 00 00 Alev Yayan Flammable </p> <p>12 'li Sıva Altı W Otomat Kutusu Flush-Mounted Fuse Box, 12 Fuses</p> <table border="1"> <tr> <td>Ambalaj Şekli / Package Type</td> <td>Kutu / Pack</td> </tr> <tr> <td>Adet / m / Quantity / m</td> <td>10</td> </tr> <tr> <td>Ağırlık / Weight</td> <td>6.80 kg</td> </tr> <tr> <td>m³ / Volume</td> <td>0.063</td> </tr> </table>	Ambalaj Şekli / Package Type	Kutu / Pack	Adet / m / Quantity / m	10	Ağırlık / Weight	6.80 kg	m ³ / Volume	0.063
Ambalaj Şekli / Package Type	Kutu / Pack																
Adet / m / Quantity / m	10																
Ağırlık / Weight	6.70 kg																
m ³ / Volume	0.063																
Ambalaj Şekli / Package Type	Kutu / Pack																
Adet / m / Quantity / m	10																
Ağırlık / Weight	6.80 kg																
m ³ / Volume	0.063																
 <p>001 057 120018 00 00 Alev Yayan Flammable </p> <p>18 'li Sıva Üstü W Otomat Kutusu (Kapaklı) Surface-Mounted Fuse Box (With Cover), 18 Fuses</p> <table border="1"> <tr> <td>Ambalaj Şekli / Package Type</td> <td>Kutu / Pack</td> </tr> <tr> <td>Adet / m / Quantity / m</td> <td>10</td> </tr> <tr> <td>Ağırlık / Weight</td> <td>9.98 kg</td> </tr> <tr> <td>m³ / Volume</td> <td>0.088</td> </tr> </table>	Ambalaj Şekli / Package Type	Kutu / Pack	Adet / m / Quantity / m	10	Ağırlık / Weight	9.98 kg	m ³ / Volume	0.088	 <p>001 057 020018 00 00 Alev Yayan Flammable </p> <p>18 'li Sıva Altı W Otomat Kutusu Flush-Mounted Fuse Box, 18 Fuses</p> <table border="1"> <tr> <td>Ambalaj Şekli / Package Type</td> <td>Kutu / Pack</td> </tr> <tr> <td>Adet / m / Quantity / m</td> <td>10</td> </tr> <tr> <td>Ağırlık / Weight</td> <td>9.10 kg</td> </tr> <tr> <td>m³ / Volume</td> <td>0.088</td> </tr> </table>	Ambalaj Şekli / Package Type	Kutu / Pack	Adet / m / Quantity / m	10	Ağırlık / Weight	9.10 kg	m ³ / Volume	0.088
Ambalaj Şekli / Package Type	Kutu / Pack																
Adet / m / Quantity / m	10																
Ağırlık / Weight	9.98 kg																
m ³ / Volume	0.088																
Ambalaj Şekli / Package Type	Kutu / Pack																
Adet / m / Quantity / m	10																
Ağırlık / Weight	9.10 kg																
m ³ / Volume	0.088																
 <p>001 057 120024 00 00 Alev Yayan Flammable </p> <p>24 'lü Sıva Üstü W Otomat Kutusu (Kapaklı) Surface-Mounted Fuse Box (With Cover), 24 Fuses</p> <table border="1"> <tr> <td>Ambalaj Şekli / Package Type</td> <td>Kutu / Pack</td> </tr> <tr> <td>Adet / m / Quantity / m</td> <td>5</td> </tr> <tr> <td>Ağırlık / Weight</td> <td>6.17 kg</td> </tr> <tr> <td>m³ / Volume</td> <td>0.047</td> </tr> </table>	Ambalaj Şekli / Package Type	Kutu / Pack	Adet / m / Quantity / m	5	Ağırlık / Weight	6.17 kg	m ³ / Volume	0.047	 <p>001 057 020024 00 00 Alev Yayan Flammable </p> <p>24 'lü Sıva Altı W Otomat Kutusu Flush-Mounted Fuse Box, 24 Fuses</p> <table border="1"> <tr> <td>Ambalaj Şekli / Package Type</td> <td>Kutu / Pack</td> </tr> <tr> <td>Adet / m / Quantity / m</td> <td>5</td> </tr> <tr> <td>Ağırlık / Weight</td> <td>6.00 kg</td> </tr> <tr> <td>m³ / Volume</td> <td>0.047</td> </tr> </table>	Ambalaj Şekli / Package Type	Kutu / Pack	Adet / m / Quantity / m	5	Ağırlık / Weight	6.00 kg	m ³ / Volume	0.047
Ambalaj Şekli / Package Type	Kutu / Pack																
Adet / m / Quantity / m	5																
Ağırlık / Weight	6.17 kg																
m ³ / Volume	0.047																
Ambalaj Şekli / Package Type	Kutu / Pack																
Adet / m / Quantity / m	5																
Ağırlık / Weight	6.00 kg																
m ³ / Volume	0.047																
 <p>001 057 120036 00 00 Alev Yayan Flammable </p> <p>36 'lı Sıva Üstü W Otomat Kutusu (Kapaklı) Surface-Mounted Fuse Box (With Cover), 36 Fuses</p> <table border="1"> <tr> <td>Ambalaj Şekli / Package Type</td> <td>Kutu / Pack</td> </tr> <tr> <td>Adet / m / Quantity / m</td> <td>5</td> </tr> <tr> <td>Ağırlık / Weight</td> <td>7.77 kg</td> </tr> <tr> <td>m³ / Volume</td> <td>0.063</td> </tr> </table>	Ambalaj Şekli / Package Type	Kutu / Pack	Adet / m / Quantity / m	5	Ağırlık / Weight	7.77 kg	m ³ / Volume	0.063	 <p>001 057 020036 00 00 Alev Yayan Flammable </p> <p>36 'lı Sıva Altı W Otomat Kutusu Flush-Mounted Fuse Box, 36 Fuses</p> <table border="1"> <tr> <td>Ambalaj Şekli / Package Type</td> <td>Kutu / Pack</td> </tr> <tr> <td>Adet / m / Quantity / m</td> <td>5</td> </tr> <tr> <td>Ağırlık / Weight</td> <td>7.33 kg</td> </tr> <tr> <td>m³ / Volume</td> <td>0.063</td> </tr> </table>	Ambalaj Şekli / Package Type	Kutu / Pack	Adet / m / Quantity / m	5	Ağırlık / Weight	7.33 kg	m ³ / Volume	0.063
Ambalaj Şekli / Package Type	Kutu / Pack																
Adet / m / Quantity / m	5																
Ağırlık / Weight	7.77 kg																
m ³ / Volume	0.063																
Ambalaj Şekli / Package Type	Kutu / Pack																
Adet / m / Quantity / m	5																
Ağırlık / Weight	7.33 kg																
m ³ / Volume	0.063																

COMFORT W OTOMAT KUTULARI (ALEV YAYMAYAN) COMFORT FUSE BOXES (NON FLAMMABLE)

IP40

001 057 110006 00 00 Alev Yaymayan
Non Flammable



6 'lı Sıva Üstü W Otomat Kutusu (Kapaklı)
Surface-Mounted Fuse Box (With Cover), 6 Fuses

Ambalaj Şekli / Package Type	Kutu / Pack
Adet / m / Quantity / m	20
Ağırlık / Weight	7.76 kg
m ³ / Volume	0.058

001 057 010006 00 00 Alev Yaymayan
Non Flammable

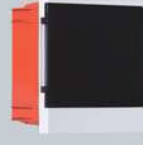

6 'lı Sıva Altı W Otomat Kutusu
Flush-Mounted Fuse Box, 6 Fuses

Ambalaj Şekli / Package Type	Kutu / Pack
Adet / m / Quantity / m	20
Ağırlık / Weight	9.10 kg
m ³ / Volume	0.058

001 057 110009 00 00 Alev Yaymayan
Non Flammable



9 'lu Sıva Üstü W Otomat Kutusu (Kapaklı)
Surface-Mounted Fuse Box (With Cover), 9 Fuses

Ambalaj Şekli / Package Type	Kutu / Pack
Adet / m / Quantity / m	20
Ağırlık / Weight	9.64 kg
m ³ / Volume	0.080

001 057 010009 00 00 Alev Yaymayan
Non Flammable



9 'lu Sıva Altı W Otomat Kutusu
Flush-Mounted Fuse Box, 9 Fuses

Ambalaj Şekli / Package Type	Kutu / Pack
Adet / m / Quantity / m	20
Ağırlık / Weight	8.60 kg
m ³ / Volume	0.080

001 057 110012 00 00 Alev Yaymayan
Non Flammable



12 'li Sıva Üstü W Otomat Kutusu (Kapaklı)
Surface-Mounted Fuse Box (With Cover), 12 Fuses

Ambalaj Şekli / Package Type	Kutu / Pack
Adet / m / Quantity / m	10
Ağırlık / Weight	6.70 kg
m ³ / Volume	0.063

001 057 010012 00 00 Alev Yaymayan
Non Flammable



12 'li Sıva Altı W Otomat Kutusu
Flush-Mounted Fuse Box, 12 Fuses

Ambalaj Şekli / Package Type	Kutu / Pack
Adet / m / Quantity / m	10
Ağırlık / Weight	6.80 kg
m ³ / Volume	0.063

001 057 110018 00 00 Alev Yaymayan
Non Flammable



18 'li Sıva Üstü W Otomat Kutusu (Kapaklı)
Surface-Mounted Fuse Box (With Cover), 18 Fuses

Ambalaj Şekli / Package Type	Kutu / Pack
Adet / m / Quantity / m	10
Ağırlık / Weight	9.98 kg
m ³ / Volume	0.088

001 057 010018 00 00 Alev Yaymayan
Non Flammable



18 'li Sıva Altı W Otomat Kutusu
Flush-Mounted Fuse Box, 18 Fuses

Ambalaj Şekli / Package Type	Kutu / Pack
Adet / m / Quantity / m	10
Ağırlık / Weight	9.10 kg
m ³ / Volume	0.088

001 057 110024 00 00 Alev Yaymayan
Non Flammable



24 'lü Sıva Üstü W Otomat Kutusu (Kapaklı)
Surface-Mounted Fuse Box (With Cover), 24 Fuses

Ambalaj Şekli / Package Type	Kutu / Pack
Adet / m / Quantity / m	5
Ağırlık / Weight	6.17 kg
m ³ / Volume	0.047

001 057 010024 00 00 Alev Yaymayan
Non Flammable



24 'lü Sıva Altı W Otomat Kutusu
Flush-Mounted Fuse Box, 24 Fuses

Ambalaj Şekli / Package Type	Kutu / Pack
Adet / m / Quantity / m	5
Ağırlık / Weight	6.00 kg
m ³ / Volume	0.047

001 057 110036 00 00 Alev Yaymayan
Non Flammable



36 'lı Sıva Üstü W Otomat Kutusu (Kapaklı)
Surface-Mounted Fuse Box (With Cover), 36 Fuses

Ambalaj Şekli / Package Type	Kutu / Pack
Adet / m / Quantity / m	5
Ağırlık / Weight	7.77 kg
m ³ / Volume	0.063

001 057 010036 00 00 Alev Yaymayan
Non Flammable



36 'lı Sıva Altı W Otomat Kutusu
Flush-Mounted Fuse Box, 36 Fuses

Ambalaj Şekli / Package Type	Kutu / Pack
Adet / m / Quantity / m	5
Ağırlık / Weight	7.33 kg
m ³ / Volume	0.063

COMFORT W OTOMAT KUTULARI COMFORT FUSE BOXES

IP40

001 057 100006 00 00



6 'li Siva Üstü W Otomat Kutusu (Kapaklı)
Surface-Mounted Fuse Box (With Cover), 6 Fuses

Ambalaj Şekli / Package Type	Kutu / Pack
Adet / m / Quantity / m	20
Ağırlık / Weight	10.46 kg
m ³ / Volume	0.058

001 057 000006 00 00



6 'li Siva Altı W Otomat Kutusu
Flush-Mounted Fuse Box, 6 Fuses

Ambalaj Şekli / Package Type	Kutu / Pack
Adet / m / Quantity / m	20
Ağırlık / Weight	9.88 kg
m ³ / Volume	0.058

001 057 100009 00 00



9 'lu Siva Üstü W Otomat Kutusu (Kapaklı)
Surface-Mounted Fuse Box (With Cover), 9 Fuses

Ambalaj Şekli / Package Type	Kutu / Pack
Adet / m / Quantity / m	20
Ağırlık / Weight	12.93 kg
m ³ / Volume	0.080

001 057 000009 00 00



9 'lu Siva Altı W Otomat Kutusu
Flush-Mounted Fuse Box, 9 Fuses

Ambalaj Şekli / Package Type	Kutu / Pack
Adet / m / Quantity / m	20
Ağırlık / Weight	12.35 kg
m ³ / Volume	0.080

001 057 100012 00 00



12 'li Siva Üstü W Otomat Kutusu (Kapaklı)
Surface-Mounted Fuse Box (With Cover), 12 Fuses

Ambalaj Şekli / Package Type	Kutu / Pack
Adet / m / Quantity / m	10
Ağırlık / Weight	8.72 kg
m ³ / Volume	0.063

001 057 000012 00 00



12 'li Siva Altı W Otomat Kutusu
Flush-Mounted Fuse Box, 12 Fuses

Ambalaj Şekli / Package Type	Kutu / Pack
Adet / m / Quantity / m	10
Ağırlık / Weight	8.60 kg
m ³ / Volume	0.063

001 057 100018 00 00



18 'li Siva Üstü W Otomat Kutusu (Kapaklı)
Surface-Mounted Fuse Box (With Cover), 18 Fuses

Ambalaj Şekli / Package Type	Kutu / Pack
Adet / m / Quantity / m	10
Ağırlık / Weight	12.60 kg
m ³ / Volume	0.088

001 057 000018 00 00



18 'li Siva Altı W Otomat Kutusu
Flush-Mounted Fuse Box, 18 Fuses

Ambalaj Şekli / Package Type	Kutu / Pack
Adet / m / Quantity / m	10
Ağırlık / Weight	11.73 kg
m ³ / Volume	0.088

001 057 100024 00 00



24 'lü Siva Üstü W Otomat Kutusu (Kapaklı)
Surface-Mounted Fuse Box (With Cover), 24 Fuses

Ambalaj Şekli / Package Type	Kutu / Pack
Adet / m / Quantity / m	5
Ağırlık / Weight	7.44 kg
m ³ / Volume	0.047

001 057 000024 00 00



24 'lü Siva Altı W Otomat Kutusu
Flush-Mounted Fuse Box, 24 Fuses

Ambalaj Şekli / Package Type	Kutu / Pack
Adet / m / Quantity / m	5
Ağırlık / Weight	6.94 kg
m ³ / Volume	0.047

001 057 100036 00 00



36 'li Siva Üstü W Otomat Kutusu (Kapaklı)
Surface-Mounted Fuse Box (With Cover), 36 Fuses

Ambalaj Şekli / Package Type	Kutu / Pack
Adet / m / Quantity / m	5
Ağırlık / Weight	9.44 kg
m ³ / Volume	0.063

001 057 000036 00 00



36 'li Siva Altı W Otomat Kutusu
Flush-Mounted Fuse Box, 36 Fuses

Ambalaj Şekli / Package Type	Kutu / Pack
Adet / m / Quantity / m	5
Ağırlık / Weight	9.38 kg
m ³ / Volume	0.063

COMFORT W OTOMAT KUTULARI
COMFORT FUSE BOXES

IP40

COMFORT MÜHÜRLÜ SİGORTA KUTULARI SEALED FUSE BOXES**1 'li Sıva Üstü
Mühürlü Sigorta Kutusu**Surface Mounted Sealed
Fuse Box, 1 Fuse

001 057 200001 00 00

Ambalaj Şekli / Package Type	Kutu / Pack
Adet / m / Quantity / m	20
Ağırlık / Weight	1.42 kg
m ³ / Volume	0.254

**1-2 'li Sıva Üstü
Mühürlü Sigorta Kutusu**Surface Mounted Sealed
Fuse Box, 1-2 Fuses

001 057 200002 00 00

Ambalaj Şekli / Package Type	Kutu / Pack
Adet / m / Quantity / m	20
Ağırlık / Weight	1.64 kg
m ³ / Volume	0.046

**3-4 'li Sıva Üstü
Mühürlü Sigorta Kutusu**Surface Mounted Sealed
Fuse Box, 3-4 Fuses

001 057 200004 00 00

Ambalaj Şekli / Package Type	Kutu / Pack
Adet / m / Quantity / m	10
Ağırlık / Weight	0.94 kg
m ³ / Volume	0.023

COMFORT MÜHÜRLÜ SİGORTA KUTULARI (ALEV YAYMAYAN) MEKS SERIES SEALED FUSE BOXES (NON FLAMMABLE)**1 'li Sıva Üstü
Mühürlü Sigorta Kutusu**Surface Mounted Sealed
Fuse Box, 1 Fuse

001 057 210001 00 00

Ambalaj Şekli / Package Type	Kutu / Pack
Adet / m / Quantity / m	20
Ağırlık / Weight	2.46 kg
m ³ / Volume	0.093

**1-2 'li Sıva Üstü
Mühürlü Sigorta Kutusu**Surface Mounted Sealed
Fuse Box, 1-2 Fuses

001 057 210002 00 00

Ambalaj Şekli / Package Type	Kutu / Pack
Adet / m / Quantity / m	20
Ağırlık / Weight	1.64 kg
m ³ / Volume	0.046

**3-4 'li Sıva Üstü
Mühürlü Sigorta Kutusu**Surface Mounted Sealed
Fuse Box, 3-4 Fuses

001 057 210004 00 00

Ambalaj Şekli / Package Type	Kutu / Pack
Adet / m / Quantity / m	10
Ağırlık / Weight	0.94 kg
m ³ / Volume	0.023

COMFORT MÜHÜRLÜ SİGORTA KUTULARI H.FREE (ALEV YAYAN) MEKS SERIES SEALED FUSE BOXES H.FREE (FLAMMABLE)**1 'li Sıva Üstü
Mühürlü Sigorta Kutusu**Surface Mounted Sealed
Fuse Box, 1 Fuse

001 057 220001 00 00

Ambalaj Şekli / Package Type	Kutu / Pack
Adet / m / Quantity / m	20
Ağırlık / Weight	1.42 kg
m ³ / Volume	0.254

**1-2 'li Sıva Üstü
Mühürlü Sigorta Kutusu**Surface Mounted Sealed
Fuse Box, 1-2 Fuses

001 057 220002 00 00

Ambalaj Şekli / Package Type	Kutu / Pack
Adet / m / Quantity / m	20
Ağırlık / Weight	1.64 kg
m ³ / Volume	0.046

**3-4 'li Sıva Üstü
Mühürlü Sigorta Kutusu**Surface Mounted Sealed
Fuse Box, 3-4 Fuses

001 057 220004 00 00

Ambalaj Şekli / Package Type	Kutu / Pack
Adet / m / Quantity / m	10
Ağırlık / Weight	0.94 kg
m ³ / Volume	0.023

COMFORT W Otomat Zayıf akım kutusu

Comfort fuse and
low-current
boxes



İkisi bir arada

Hem sigorta kutusu hem zayıf akım kutusu

- İçerisine Modem, Acces Point, Switch, Tv Dağıtıcı ve cihazların enerji beslemesi için grup priz montajı yapılabilen zayıf akım kutuları ile elektrik ve data tesisatlarındaki karmaşıklığı minimize etmek, arıza tespitini hızlı bir şekilde çözüme kavuşturmak mümkündür.
- Kullanacağınız cihaz sayısına göre farklı ebatlardaki zayıf akım kutularımız, tabanı sac - kapağı plastik ya da tamamı sac olan seçenekleriyle ürün gamımıza eklenmiştir

Two in One

Both the fuse box and the weak current box

- It is possible to minimize the complexity of electrical and data installations and solve the problem quickly with Modem, Access Point, Switch, TV Distributor and weak current boxes which can be grouped for power supply of devices.
- Depending on the number of devices you will use, our product range has been added with the choices of low current boxes in different sizes, sheet metal - cover plastic or all sheet metal.





BOYUTLAR • DIMENSIONS

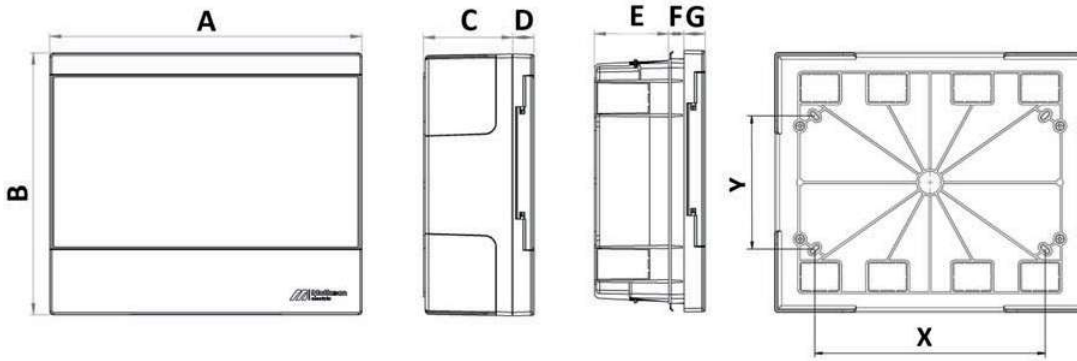

ÖLÇÜLER / SIZES	SIVA ALTI FLUSH		A	B	C	D	E	F	G	X	Y
		ZAYIF AKIM 205 X 250 (İÇ ÖLÇÜ)	275	230			65,5	13,5	18,5		
ZAYIF AKIM 248 X 318 (İÇ ÖLÇÜ)	275	345			65,5	13,5	18,5				
12 SİGORTA + ZAYIF AKIM	275	345			65,5	13,5	18,5				
24 SİGORTA + ZAYIF AKIM	275	460			65,5	13,5	18,5				
SIVA ÜSTÜ SURFACE		A	B	C	D	E	F	G	X	Y	
	ZAYIF AKIM 205 X 250 (İÇ ÖLÇÜ)	275	230	78,8	18,5				204	118	
ZAYIF AKIM 248 X 318 (İÇ ÖLÇÜ)	275	345	78,8	18,5				204	233		
12 SİGORTA + ZAYIF AKIM	275	345	78,8	18,5				204	233		
24 SİGORTA + ZAYIF AKIM	275	460	78,8	18,5				204	348		

AKSESUAR • ACCESSORY



001 057 990001 00 00

S/A COMFORT ALÇIPAN MONTAJ SETİ
FLUSH MOUNTED COMFORT PLASTER

Ambalaj Şekli / Package Type	Kutu / Pack
Adet / m / Quantity / m	50
Ağırlık / Weight	0.46 kg
m ³ / Volume	0.001

COMFORT W OTOMAT ZAYIF AKIM KUTULARI
COMFORT FUSE AND LOW-CURRENT BOXES

IP40

001 057 101012 00 00

Sıva Üstü Zayıf Akım Kutusu (225x270)
 Surface Mounted Low Current Box (225x270)

Ambalaj Şekli / Package Type	Kutu / Pack
Adet / m / Quantity / m	10
Ağırlık / Weight	8.21 kg
m ³ / Volume	0.064

001 057 001012 00 00

Sıva Altı Zayıf Akım Kutusu (225x270)
 Flush Mounted Low Current Box (225x270)

Ambalaj Şekli / Package Type	Kutu / Pack
Adet / m / Quantity / m	10
Ağırlık / Weight	8.44 kg
m ³ / Volume	0.064

001 057 101020 00 00

Sıva Üstü Zayıf Akım Kutusu (270x340)
 Surface Mounted Low Current Box (270x340)

Ambalaj Şekli / Package Type	Kutu / Pack
Adet / m / Quantity / m	10
Ağırlık / Weight	14.89 kg
m ³ / Volume	0.095

001 057 001020 00 00

Sıva Altı Zayıf Akım Kutusu (270x340)
 Flush Mounted Low Current Box (270x340)

Ambalaj Şekli / Package Type	Kutu / Pack
Adet / m / Quantity / m	10
Ağırlık / Weight	8.44 kg
m ³ / Volume	0.064

001 057 101024 00 00

Sıva Üstü 12'li Sigorta +Zayıf Akım Kutusu
 Surface Mounted Fuse Box (12)+
 Low Current Box

Ambalaj Şekli / Package Type	Kutu / Pack
Adet / m / Quantity / m	5
Ağırlık / Weight	4.91 kg
m ³ / Volume	0.017

001 057 001024 00 00

Sıva Altı 12'li Sigorta +Zayıf Akım Kutusu
 Flush Mounted Fuse Box (12)+
 Low Current Box

Ambalaj Şekli / Package Type	Kutu / Pack
Adet / m / Quantity / m	5
Ağırlık / Weight	4.30 kg
m ³ / Volume	0.031

001 057 101036 00 00

Sıva Üstü 24'lü Sigorta +Zayıf Akım Kutusu
 Surface Mounted Fuse Box (24)+
 Low Current Box

Ambalaj Şekli / Package Type	Kutu / Pack
Adet / m / Quantity / m	5
Ağırlık / Weight	5.65 kg
m ³ / Volume	0.047

001 057 001036 00 00

Sıva Altı 24'lü Sigorta +Zayıf Akım Kutusu
 Flush Mounted Fuse Box (24)+
 Low Current Box

Ambalaj Şekli / Package Type	Kutu / Pack
Adet / m / Quantity / m	5
Ağırlık / Weight	5.65 kg
m ³ / Volume	0.047

COMFORT W OTOMAT ZAYIF AKIM KUTULARI (ALEV YAYMAYAN) COMFORT FUSE AND LOW-CURRENT BOXES (NON FLAMMABLE)

IP40

001 057 111012 00 00 Alev Yaymayan
Non Flammable

Sıva Üstü Zayıf Akım Kutusu (225x270)
Surface Mounted Low Current Box (225x270)



Ambalaj Şekli / Package Type	Kutu / Pack
Adet / m / Quantity / m	10
Ağırlık / Weight	8.21 kg
m ³ / Volume	0.064

001 057 011012 00 00 Alev Yaymayan
Non Flammable

Sıva Altı Zayıf Akım Kutusu (225x270)
Flush Mounted Low Current Box (225x270)



Ambalaj Şekli / Package Type	Kutu / Pack
Adet / m / Quantity / m	10
Ağırlık / Weight	8.60 kg
m ³ / Volume	0.063

001 057 111020 00 00 Alev Yaymayan
Non Flammable

Sıva Üstü Zayıf Akım Kutusu (270x340)
Surface Mounted Low Current Box (270x340)



Ambalaj Şekli / Package Type	Kutu / Pack
Adet / m / Quantity / m	10
Ağırlık / Weight	14.89 kg
m ³ / Volume	0.095

001 057 011020 00 00 Alev Yaymayan
Non Flammable

Sıva Altı Zayıf Akım Kutusu (270x340)
Flush Mounted Low Current Box (270x340)



Ambalaj Şekli / Package Type	Kutu / Pack
Adet / m / Quantity / m	10
Ağırlık / Weight	11.31 kg
m ³ / Volume	0.095

001 057 111024 00 00 Alev Yaymayan
Non Flammable

Sıva Üstü 12'li Sigorta +Zayıf Akım Kutusu
Surface Mounted Fuse Box (12)+
Low Current Box



Ambalaj Şekli / Package Type	Kutu / Pack
Adet / m / Quantity / m	5
Ağırlık / Weight	4.91 kg
m ³ / Volume	0.063

001 057 011024 00 00 Alev Yaymayan
Non Flammable

Sıva Altı 12'li Sigorta +Zayıf Akım Kutusu
Flush Mounted Fuse Box (12)+
Low Current Box



Ambalaj Şekli / Package Type	Kutu / Pack
Adet / m / Quantity / m	5
Ağırlık / Weight	6.83 kg
m ³ / Volume	0.063

001 057 111036 00 00 Alev Yaymayan
Non Flammable

Sıva Üstü 24'lü Sigorta +Zayıf Akım Kutusu
Surface Mounted Fuse Box (24)+
Low Current Box



Ambalaj Şekli / Package Type	Kutu / Pack
Adet / m / Quantity / m	5
Ağırlık / Weight	5.65 kg
m ³ / Volume	0.047

001 057 011036 00 00 Alev Yaymayan
Non Flammable

Sıva Altı 24'lü Sigorta +Zayıf Akım Kutusu
Flush Mounted Fuse Box (24)+
Low Current Box



Ambalaj Şekli / Package Type	Kutu / Pack
Adet / m / Quantity / m	5
Ağırlık / Weight	5.65 kg
m ³ / Volume	0.047

COMFORT W OTOMAT ZAYIF AKIM KUTULARI H. FREE (ALEV YAYAN)
COMFORT FUSE AND LOW-CURRENT BOXES H.FREE (FLAMMABLE)

IP40

001 057 121012 00 00 Alev Yayan
Flammable 
Sıva Üstü Zayıf Akım Kutusu (225x270)
 Surface Mounted Low Current Box (225x270)



Ambalaj Şekli / Package Type	Kutu / Pack
Adet / m / Quantity / m	10
Ağırlık / Weight	8.21 kg
m ³ / Volume	0.064

001 057 021012 00 00 Alev Yayan
Flammable 
Sıva Altı Zayıf Akım Kutusu (225x270)
 Flush Mounted Low Current Box (225x270)



Ambalaj Şekli / Package Type	Kutu / Pack
Adet / m / Quantity / m	10
Ağırlık / Weight	8.60 kg
m ³ / Volume	0.063

001 057 121020 00 00 Alev Yayan
Flammable 
Sıva Üstü Zayıf Akım Kutusu (270x340)
 Surface Mounted Low Current Box (270x340)

Ambalaj Şekli / Package Type	Kutu / Pack
Adet / m / Quantity / m	10
Ağırlık / Weight	14.89 kg
m ³ / Volume	0.095

001 057 002120 00 00 Alev Yayan
Flammable 
Sıva Altı Zayıf Akım Kutusu (270x340)
 Flush Mounted Low Current Box (270x340)



Ambalaj Şekli / Package Type	Kutu / Pack
Adet / m / Quantity / m	10
Ağırlık / Weight	11.31 kg
m ³ / Volume	0.095

001 057 121024 00 00 Alev Yayan
Flammable 
Sıva Üstü 12'li Sigorta +Zayıf Akım Kutusu
 Surface Mounted Fuse Box (12)+
 Low Current Box



Ambalaj Şekli / Package Type	Kutu / Pack
Adet / m / Quantity / m	5
Ağırlık / Weight	4.91 kg
m ³ / Volume	0.063

001 057 0021024 00 00 Alev Yayan
Flammable 
Sıva Altı 12'li Sigorta +Zayıf Akım Kutusu
 Flush Mounted Fuse Box (12)+
 Low Current Box

Ambalaj Şekli / Package Type	Kutu / Pack
Adet / m / Quantity / m	5
Ağırlık / Weight	4.30 kg
m ³ / Volume	0.031

001 057 121036 00 00 Alev Yayan
Flammable 
Sıva Üstü 24'lü Sigorta +Zayıf Akım Kutusu
 Surface Mounted Fuse Box (24)+
 Low Current Box

Ambalaj Şekli / Package Type	Kutu / Pack
Adet / m / Quantity / m	5
Ağırlık / Weight	5.65 kg
m ³ / Volume	0.047

001 057 021036 00 00 Alev Yayan
Flammable 
Sıva Altı 24'lü Sigorta +Zayıf Akım Kutusu
 Flush Mounted Fuse Box (24)+
 Low Current Box

Ambalaj Şekli / Package Type	Kutu / Pack
Adet / m / Quantity / m	5
Ağırlık / Weight	5.65 kg
m ³ / Volume	0.047

COMFORT W OTOMAT ZAYIF AKIM KUTULARI (METAL)

METAL COMFORT MCB LOW CURRENT BOX



001 058 000012 00 00 **12'li Sıva Altı Metal Tabanlı + Plastik Kapaklı Otomatik Sigorta Kutusu**
Distribution Box - 12 Modules Metal Base + Plastic Cover Flush Type

001 058 001012 00 00 **Sıva Altı Metal Tabanlı + Plastik Kapaklı Zayıf Akım Kutusu**
Low Current Box Metal Base + Plastic Cover Flush Type

Ankastre Ölçüsü / Mounting Dimension 210 x 252 x 80 mm

Ürün Ölçüsü / Product Dimension 230 x 275 x 102 mm

Tekli Kutu Ölçüsü / Single Box Dimension 281 x 238 x 104 mm

Ağırlık / Weight 2,02 Kg.



001 058 000024 00 00 **24'lü Sıva Altı Metal Tabanlı + Plastik Kapaklı Otomatik Sigorta Kutusu**
Distribution Box - 24 Modules Metal Base + Plastic Cover Flush Type

001 058 001024 00 00 **12 Sigortalı + Zayıf Akım Bölmeli Sıva Altı Metal Tabanlı + Plastik Kapaklı Kutu**
Distribution Box 12 Modules + Low Current Box Metal Base + Plastic Cover Flush Type

001 058 502532 00 00 **250 x 320 mm Sıva Altı Metal Tabanlı + Plastik Kapaklı Zayıf Akım Kutusu**
Low Current Box 250 x320mm Metal Base + Plastic Cover Flush Type

Ankastre Ölçüsü / Mounting Dimension 255 x 324 x 80 mm

Ürün Ölçüsü / Product Dimension 275 x 345 x 102 mm

Tekli Kutu Ölçüsü / Single Box Dimension 350 x 283 x 104 mm

Ağırlık / Weight 2,95 Kg.



001 058 000036 00 00 **36'lı Sıva Altı Metal Tabanlı + Plastik Kapaklı Otomatik Sigorta Kutusu**
Distribution Box - 36 Modules Metal Base + Plastic Cover Flush Type

001 058 001036 00 00 **24 Sigortalı + Zayıf Akım Bölmeli Sıva Altı Metal Tabanlı + Plastik Kapaklı Kutu**
Distribution Box 24 Modules + Low Current Box Metal Base + Plastic Cover Flush Type

Ankastre Ölçüsü / Mounting Dimension 255 x 440 x 80 mm

Ürün Ölçüsü / Product Dimension 275 x 46 x 102 mm

Tekli Kutu Ölçüsü / Single Box Dimension 465 x 282 x 105 mm

Ağırlık / Weight 3,85 Kg.



001 058 602532 00 00 **250 mm x 320 mm Sıva Altı Zayıf Akım Kutusu**
Metal Low Current Box 250 mm x 320 mm Flush Type

Ankastre Ölçüsü / Mounting Dimension 250 x 320 x 73 mm

Ambalaj Ölçüsü / Box Dimension 460 x 300 x 110 mm

Ağırlık / Weight 3.70 Kg.

COMFORT W OTOMAT ZAYIF AKIM KUTULARI (METAL)

METAL COMFORT MCB LOW CURRENT BOX



001 058 602544 00 00 **250 mm x 440 mm Metal Sıva Altı Zayıf Akım Kutusu**
Metal Low Current Box 250 mm x 440 mm Flush Type

Ankastre Ölçüsü / Mounting Dimension	250 x 440 x 73 mm
--------------------------------------	-------------------

Ambalaj Ölçüsü / Box Dimension	570 x 300 x 110 mm
--------------------------------	--------------------

Ağırlık / Weight	4,70 Kg.
------------------	----------



001 058 604040 00 00 **400 x 400 mm Sıva Altı Metal Zayıf Akım Kutusu**
Metal Low Current Box 400 x 400 mm Lush Type

Ankastre Ölçüsü / Mounting Dimension	400 x 400 x 73 mm
--------------------------------------	-------------------

Ambalaj Ölçüsü / Box Dimension	520 x 520 x 110 mm
--------------------------------	--------------------

Ağırlık / Weight	6.50 Kg.
------------------	----------



001 058 400036 00 00 **24 Sigortalı + Zayıf Akım Bölmeli Sıva Altı Metal Kutu**
Metal Distribution Box 24 Modules + Low Current Box Flush Type

Ankastre Ölçüsü / Mounting Dimension	700 x 300 x 80 mm
--------------------------------------	-------------------

Ambalaj Ölçüsü / Box Dimension	730 x 330 x 110 mm
--------------------------------	--------------------

Ağırlık / Weight	9,50 Kg.
------------------	----------



001 058 400048 00 00 **36 Sigortalı + Zayıf Akım Bölmeli Sıva Altı Metal Kutu**
Metal Distribution Box 36 Modules + Low Current Box Flush Type

Ankastre Ölçüsü / Mounting Dimension	730 x 450 x 80 mm
--------------------------------------	-------------------

Ambalaj Ölçüsü / Box Dimension	780 x 500 x 110 mm
--------------------------------	--------------------

Ağırlık / Weight	11,90 Kg.
------------------	-----------

MEKSBOX

W Otomat kutuları

Fuse boxes



ÖLÇÜLER (mm) DIMENSIONS

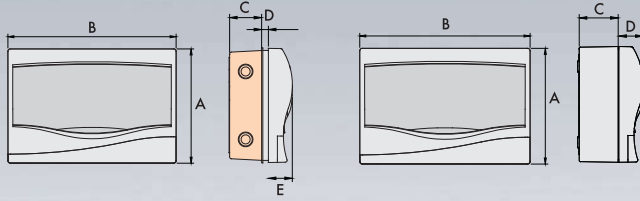

SIVAALTI W OTOMAT KUTULARI FLUSH MOUNTED FUSE BOXES

	A	B	C	D	E
2' li	142	93	53.5	11,5	40
4'lü	142	138	53.5	11,5	40
6'lı	142	163	53.5	11,5	40
9'lu	172	217	53.5	11,5	40
12'li	182	272	53.5	11,5	40
16'lı	272	207	53.5	11,5	40
24'lü	332	272	53.5	11,5	40
36'lı	482	272	53.5	11,5	40

SIVAÜSTÜ W OTOMAT KUTULARI SURFACE MOUNTED FUSE BOXES

	A	B	C	D
2' li	149	100	65	40
4'lü	150	150	65	40
6'lı	150	170	65	40
9'lu	180	225	65	40
12'li	190	280	65	40
16'lı	290	215	65	40
24'lü	340	280	65	40
36'lı	490	280	65	40

Terminal koruma seviyesi (Koruma sınıfı) Terminal protection level (Protection class)	IP 30 IP 30
Kutuların tipi Type of boxes	Dikdörtgen kutulardır. Rectangular box
Tesis sırasındaki sıcaklık aralığı Temperature range during installation	-25°C / +60°C -25°C / +60°C
Yalıtım direnci Insulation resistance	5 MΩ'un üzerindedir. Over 5 m Ohm
Yüksek gerilime dayanımı Resistance to high voltage	3750 V AC (Alternatif akım, 220 / 400 V-50 Hz) 3750 V AC (Alternating Current, 220/400 V-50 Hz)

TESİS VE UYGULAMA

Sağlam, yanmaz duvarda ve tavanda kullanıma uygundur.
İnşaat sırasında ve inşaat işleminden sonra montaja elverişlidir.

Sert, yanabilir duvarlarda ve tavanda kullanıma uygundur.

Beton içerisi hariç tüm montaj tipleri için uygundur.

Kutuların sivaüstü ve sivaaltı tespiti son derece kolay yapılabilecek şekilde tasarlanmıştır.

Kutular elektriksel korumayı sağlayacak şekilde tasarlanmıştır.

Kutuların giriş delikleri boru girişine uygundur.

Kutuların normal kullanım sürecinde oluşabilecek yaşlanma ve nemli şartlara karşı dayanıklılığı, kullanılan metal malzemelerin paslanmaya karşı dayanıklılığı, sızdırmazlık ve aşınma testleri ve elektrik çarpmasına karşı koruma testleri, ısıya dayanıklılık testleri, mekanik dayanıklılık testleri ve olağan dışı ısıya karşı dayanıklılık testleri TS EN 60670-1/ARALIK 2015 standard kapsamında yapılan yeterlilik testleri ile doğrulanmıştır.

INSTALLATION AND APPLICATION

Fuse boxes are suitable for use on sound and fireproof walls and ceilings.
The fuse boxes are suitable for installation during and after construction works.

Suitable for application on solid and combustible walls and ceilings.

Suitable for all installation types except for concrete-embedded applications.

The fuse boxes are designed for easy flush-mounted and surface mounted installation.

Fuse boxes are designed to provide electrical protection.

Inlet ports of the fuse boxes are compatible for pipe installation.

The resistance of the fuse boxes against ageing and humidity conditions that might occur during normal use, resistance of the metals used against oxidation are validated by means of permeability and abrasion tests, tests for resistance to temperature, mechanical endurance tests and extraordinary heat resistance tests conducted under the scope of TS EN 60670-1/DECEMBER 2005 standard

SIVAÜSTÜ W OTOMAT KUTULARI

SURFACE MOUNTED FUSE BOXES IP 30

SIVAALTI W OTOMAT KUTULARI

FLUSH MOUNTED FUSE BOXES IP 30

   001 027 110002 00 00 Alev Yaymayan
Non Flammable

001 027 100002 00 00 Alev Yayan
Flammable



1-2 'li Sıva Üstü W Otomat Kutusu (Kapaklı)
Surface-Mounted Fuse Box (With Cover), 1-2 Fuses

Ambalaj Şekli / Package Type	Kutu / Pack
Adet / m / Quantity / m	30
Ağırlık / Weight	9.15 kg
m ³ / Volume	0.053

   001 027 010002 00 00 Alev Yaymayan
Non Flammable

001 027 000002 00 00 Alev Yayan
Flammable



1-2 'li Sıva Altı W Otomat Kutusu (Kapaklı)
Flush-Mounted Fuse Box (With Cover), 1-2 Fuses

Ambalaj Şekli / Package Type	Kutu / Pack
Adet / m / Quantity / m	30
Ağırlık / Weight	8.85 kg
m ³ / Volume	0.053

   001 027 110004 00 00 Alev Yaymayan
Non Flammable

001 027 100004 00 00 Alev Yayan
Flammable



3-4 'lü Sıva Üstü W Otomat Kutusu (Kapaklı)
Surface-Mounted Fuse Box (With Cover), 3-4 Fuses

Ambalaj Şekli / Package Type	Kutu / Pack
Adet / m / Quantity / m	20
Ağırlık / Weight	8.48 kg
m ³ / Volume	0.053

   001 027 010004 00 00 Alev Yaymayan
Non Flammable

001 027 000004 00 00 Alev Yayan
Flammable



3-4 'lü Sıva Altı W Otomat Kutusu
Flush-Mounted Fuse Box (With Cover), 3-4 Fuses

Ambalaj Şekli / Package Type	Kutu / Pack
Adet / m / Quantity / m	20
Ağırlık / Weight	7.70 kg
m ³ / Volume	0.053

   001 027 110006 00 00 Alev Yaymayan
Non Flammable

001 027 100006 00 00 Alev Yayan
Flammable



2-6 'lı Sıva Üstü W Otomat Kutusu
Surface-Mounted Fuse Box, 2-6 Fuses

Ambalaj Şekli / Package Type	Kutu / Pack
Adet / m / Quantity / m	20
Ağırlık / Weight	9.84 kg
m ³ / Volume	0.060

   001 027 010006 00 00 Alev Yaymayan
Non Flammable

001 027 000006 00 00 Alev Yayan
Flammable



2-6 'lı Sıva Altı W Otomat Kutusu
Flush-Mounted Fuse Box, 2-6 Fuses

Ambalaj Şekli / Package Type	Kutu / Pack
Adet / m / Quantity / m	20
Ağırlık / Weight	9.64 kg
m ³ / Volume	0.060

   001 027 110009 00 00 Alev Yaymayan
Non Flammable

001 027 100009 00 00 Alev Yayan
Flammable



9 'lu Sıva Üstü W Otomat Kutusu
Surface-Mounted Fuse Box, 9 Fuses

Ambalaj Şekli / Package Type	Kutu / Pack
Adet / m / Quantity / m	20
Ağırlık / Weight	13.56 kg
m ³ / Volume	0.093

   001 027 010009 00 00 Alev Yaymayan
Non Flammable

001 027 000009 00 00 Alev Yayan
Flammable



9 'lu Sıva Altı W Otomat Kutusu
Flush-Mounted Fuse Box, 9 Fuses



Ambalaj Şekli / Package Type	Kutu / Pack
Adet / m / Quantity / m	20
Ağırlık / Weight	13.40 kg
m ³ / Volume	0.093

SIVAÜSTÜ W OTOMAT KUTULARI

SURFACE MOUNTED FUSE BOXES IP 30

SIVAALTI W OTOMAT KUTULARI

FLUSH MOUNTED FUSE BOXES IP 30



   001 027 11 0012 00 00 Alev Yaymayan
Non Flammable

001 027 100012 00 00 Alev Yayan
Flammable



12'li Sıva Üstü W Otomat Kutusu
Surface-Mounted Fuse Box, 12 Fuses

Ambalaj Şekli / Package Type	Kutu / Pack
Adet / m / Quantity / m	10
Ağırlık / Weight	8.56 kg
m ³ / Volume	0.063

   001 027 010012 00 00 Alev Yaymayan
Non Flammable

001 027 000012 00 00 Alev Yayan
Flammable



12'li Sıva Altı W Otomat Kutusu
Flush-Mounted Fuse Box, 12 Fuses

Ambalaj Şekli / Package Type	Kutu / Pack
Adet / m / Quantity / m	10
Ağırlık / Weight	8.28 kg
m ³ / Volume	0.063

   001 027 110016 00 00 Alev Yaymayan
Non Flammable

001 027 100016 00 00 Alev Yayan
Flammable



16'li Sıva Üstü W Otomat Kutusu
Surface-Mounted Fuse Box, 16 Fuses

Ambalaj Şekli / Package Type	Kutu / Pack
Adet / m / Quantity / m	10
Ağırlık / Weight	10.16 kg
m ³ / Volume	0.073

   001 027 010016 00 00 Alev Yaymayan
Non Flammable

001 027 000016 00 00 Alev Yayan
Flammable



16'li Sıva Altı W Otomat Kutusu
Flush-Mounted Fuse Box, 16 Fuses

Ambalaj Şekli / Package Type	Kutu / Pack
Adet / m / Quantity / m	10
Ağırlık / Weight	9.60 kg
m ³ / Volume	0.073



   001 027 110024 00 00 Alev Yaymayan
Non Flammable

001 027 100024 00 00 Alev Yayan
Flammable



24'lü Sıva Üstü W Otomat Kutusu
Surface-Mounted Fuse Box, 24 Fuses

Ambalaj Şekli / Package Type	Kutu / Pack
Adet / m / Quantity / m	5
Ağırlık / Weight	7.35 kg
m ³ / Volume	0.056

   001 027 010024 00 00 Alev Yaymayan
Non Flammable

001 027 000024 00 00 Alev Yayan
Flammable



24'lü Sıva Altı W Otomat Kutusu
Flush-Mounted Fuse Box, 24 Fuses



Ambalaj Şekli / Package Type	Kutu / Pack
Adet / m / Quantity / m	5
Ağırlık / Weight	7.18 kg
m ³ / Volume	0.056

SIVAÜSTÜ W OTOMAT KUTULARI

SURFACE MOUNTED FUSE BOXES IP 30

SIVAALTI W OTOMAT KUTULARI

FLUSH MOUNTED FUSE BOXES IP 30

   001 027 110036 00 00 Alev Yaymayan
Non Flammable

001 027 100036 00 00 Alev Yayan
Flammable



36'li Sıva Üstü W Otomat Kutusu
36 Surface Mounted Fuse Boxes
Surface-Mounted Fuse Box, 36 Fuses

Ambalaj Şekli / Package Type	Kutu / Pack
Adet / m / Quantity / m	5
Ağırlık / Weight	10.45 kg
m ³ / Volume	0.077

   001 027 010036 00 00 Alev Yaymayan
Non Flammable

001 027 000036 00 00 Alev Yayan
Flammable



36'li Sıva Altı W Otomat Kutusu
36 Flush Mounted Fuse Boxes
Flush-Mounted Fuse Box, 36 Fuses



Ambalaj Şekli / Package Type	Kutu / Pack
Adet / m / Quantity / m	5
Ağırlık / Weight	10.30 kg
m ³ / Volume	0.077

MEKS SERİSİ MÜHÜRLÜ SİGORTA KUTULARI MEKS SERIES SEALED FUSE BOXES

IP 30



1 'li Sıva Üstü Mühürlü Sigorta Kutusu
Surface Mounted Sealed
Fuse Box, 1 Fuse



001 027 210001 00 00 Alev Yaymayan
Non Flammable   

001 027 200001 00 00 Alev Yayan
Flammable

Ambalaj Şekli / Package Type	Kutu / Pack
Adet / m / Quantity / m	160
Ağırlık / Weight	9.44 Kg
m ³ / Volume	0.076



1-2 'li Sıva Üstü Mühürlü Sigorta Kutusu
Surface Mounted Sealed
Fuse Box, 1-2 Fuses



001 027 210002 00 00 Alev Yaymayan
Non Flammable   

001 027 200002 00 00 Alev Yayan
Flammable

Ambalaj Şekli / Package Type	Kutu / Pack
Adet / m / Quantity / m	80
Ağırlık / Weight	6.16 Kg
m ³ / Volume	0.048



3-4 'li Sıva Üstü Mühürlü Sigorta Kutusu
Surface Mounted Sealed
Fuse Box, 3-4 Fuses

001 027 210004 00 00 Alev Yaymayan
Non Flammable   

001 027 200004 00 00 Alev Yayan
Flammable

Ambalaj Şekli / Package Type	Kutu / Pack
Adet / m / Quantity / m	80
Ağırlık / Weight	8.40 Kg
m ³ / Volume	0.077



TELEFON DAĞITIM KUTULARI VE AKSESUARLARI

TELEPHONE DISTRIBUTION BOXES (HUBS) and ACCESSORIES

	Kod Code	Açıklama Description	Ambalaj Packing	Adet Quantity	Ağırlık Weight	Hacim Volume
 IP 40	Alev Yaymayan Non Flammable    001 049 201020 00 00	Telefon Dağıtım Kutusu 10-20 (Plastik Kilitli) Telephone Distribution Box, 10-20 Hubs (With Plastic Lock)	Kutu Pack	60	15 Kg	0.085
	Alev Yayan Flammable 001 049 001020 00 00					
 IP 40	Alev Yaymayan Non Flammable    001 049 211020 00 00	Telefon Dağıtım Kutusu 10-20 (Kilitli) Telephone Distribution Box, 10-20 Hubs (With Lock)	Kutu Pack	60	15.54 Kg	0.085
	Alev Yayan Flammable 001 049 011020 00 00					
 IP 40	Alev Yaymayan Non Flammable    001 049 201050 00 00	Telefon Dağıtım Kutusu 10-50 (Plastik Kilitli) Telephone Distribution Box, 10-50 Hubs (With Plastic Lock)	Kutu Pack	28	15.45 Kg	0.126
	Alev Yayan Flammable 001 049 001050 00 00					
 IP 40	Alev Yaymayan Non Flammable    001 049 211050 00 00	Telefon Dağıtım Kutusu 10-50 (Kilitli) Telephone Distribution Box, 10-50 Hubs (With Lock)	Kutu Pack	28	17.5 Kg	0.126
	Alev Yayan Flammable 001 049 011050 00 00					
	888 049 050002	Telefon Dağıtım Modülü (Kesmeli) Telephone Distribution Module (With interrupt feature)	Kutu Pack	400	23.2 Kg	0.062
	888 049 050001	Telefon Dağıtım Modülü (Kesmesiz) 10 Pairs Connection Module	Kutu Pack	400	23.2 Kg	0.062
	888 049 050003	İrtibatlama Aleti Connection Tool	Kutu Pack	100	10.5 Kg	0.0348
	031 049 040001	Dağıtım Kutusu Tek Jaklı Distribution Box (Single Jack)	Kutu Pack	1	0.023 Kg	0.000055
	031 049 040002	Dağıtım Kutusu Çift Jaklı Distribution Box (Double Jack)	Kutu Pack	1	0.025	0.000055

TELEFON DAĞITIM KUTULARI VE AKSESUARLARI

TELEPHONE DISTRIBUTION BOXES (HUBS) and ACCESSORIES

	Kod Code	Açıklama Description	Ambalaj Packing	Adet Quantity	Ağırlık Weight	Hacim Volume
	888 049 050008	Data Konnektörü Cat 6e (RJ 45) (8 Kontak Tolles) Data Connector Cat 6e (RJ 45) (8 Contacts)	Kutu Pack	600	8.93 Kg.	0.0615
	888 049 050009	Telefon Konnektörü (RJ 11/12) (6 Kontak) Telephone Connector (RJ 11/12) (8 Contacts)	Kutu Pack	200	1.34 Kg	0.0056
	888 049 050018	6P6C İkili Dağıtıcı Telefon Fişi 6P6C Dual Distributor Telephone Plug	Kutu Pack	500	15 Kg	0.03695
	888 049 050019	6P4C Paralel Dağıtıcı 6P4C Parallel Distributor	Kutu Pack	1000	7.5 Kg	0.0739

MODÜL BAĞLANTI ÇATISI MODULE CONNECTION RACK

	Kod Code	Açıklama Description	Ambalaj Packing	Adet Quantity	Ağırlık Weight	Hacim Volume
	001 024 000001 00 00	1 modül için Rack for 1 module	Kutu Pack	1000	25 Kg	0.051
	001 024 000002 00 00	2 modül için Rack for 2 modules	Kutu Pack	500	24 Kg	0.051
	001 024 000003 00 00	3 modül için Rack for 3 modules	Kutu Pack	400	27.60 Kg	0.051
	001 024 000004 00 00	4 modül için Rack for 4 modules	Kutu Pack	300	28.5 Kg	0.051
	001 024 000005 00 00	5 modül için Rack for 5 modules	Kutu Pack	200	22.94 Kg	0.051
	001 024 000006 00 00	6 modül için Rack for 6 modules	Kutu Pack	200	25.38 Kg	0.113
	001 024 000007 00 00	7 modül için Rack for 7 modules	Kutu Pack	150	23.02 Kg	0.98
	001 024 000008 00 00	8 modül için Rack for 8 modules	Kutu Pack	150	26.26 Kg	0.110
	001 024 000009 00 00	9 modül için Rack for 9 modules	Kutu Pack	100	19.79 Kg	0.086
	001 024 000010 00 00	10 modül için Rack for 10 modules	Kutu Pack	100	22.70 Kg	0.086

**Çelik spiral,
spiral ve borular**
Stell spirals
spirals and pipes

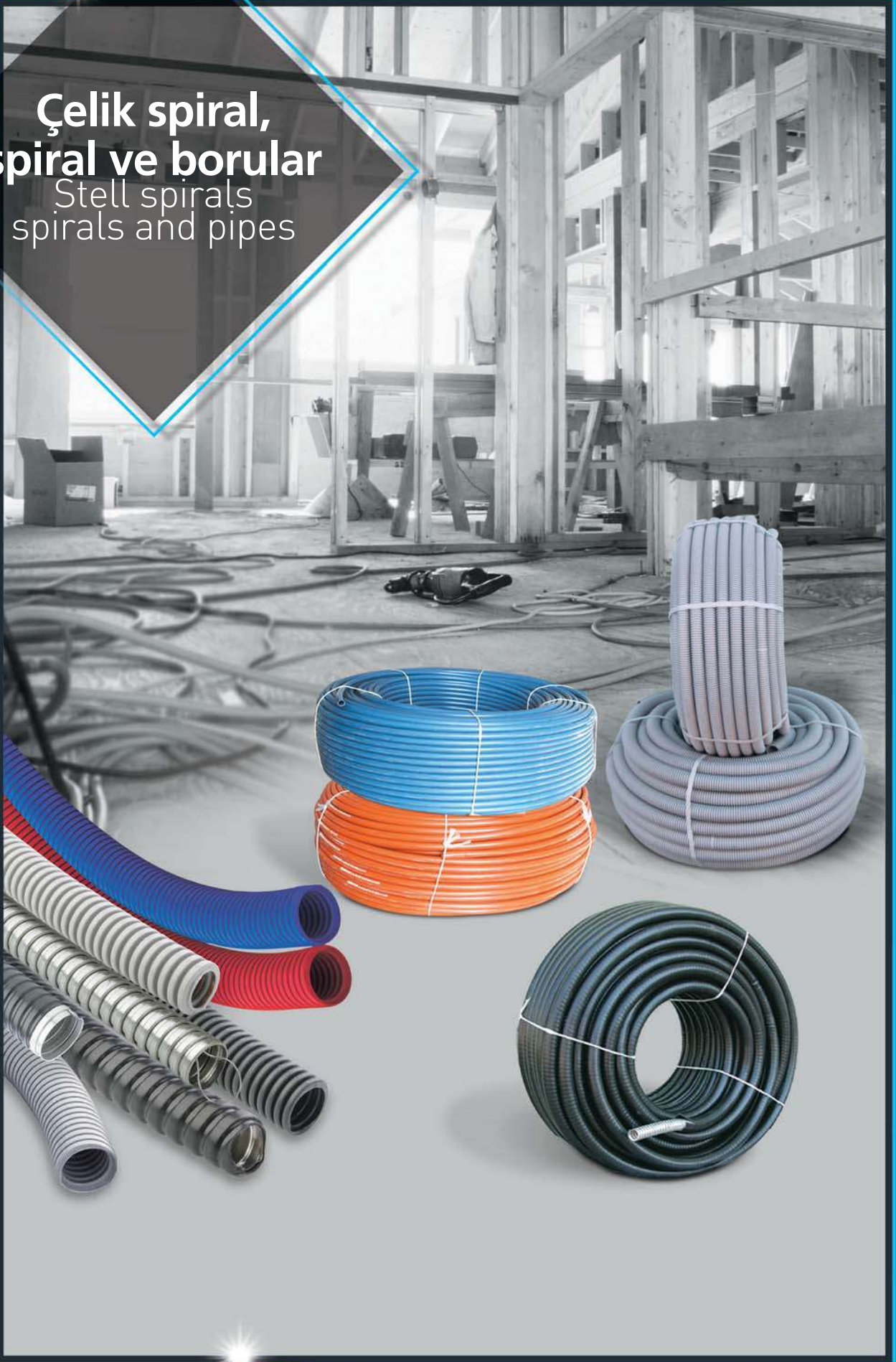

	H.FREE ALEV YAYMAYAN SİRALLER H.FREE NONFLAMMABLE SPIRALS	H.FREE ALEV YAYAN SİRALLER H.FREE FLAMMABLE SPIRALS
Boru tipi Type of the Pipe	Metalik olmayan - oluklu Nonmetallic - Corrugated	Metalik olmayan - oluklu Nonmetallic - Corrugated
Bağlantı metodu Connection method	Diş çekilmemiş Non-threaded	Diş çekilmemiş Non-threaded
Sıkıştırmaya karşı dayanıklılık Compressive Strength	Hafif (320 N) Orta (750 N) Ağır (1250 N) Low (320 N) Medium (750 N) Heavy (1250 N)	Hafif (320 N) Orta (750 N) Ağır (1250 N) Low (320 N) Medium (750 N) Heavy (1250 N)
Darbeye karşı dayanıklılık Impact Resistance	Orta (2 kg, 100 mm) -15°C'de Medium (2 kg, 100 mm) - 15°C	Orta (2 kg, 100 mm) -15°C'de Medium (2 kg, 100 mm) - 15°C
En küçük sürekli uygulama ve tesisat sıcaklığı Minimum continuous application and installation temperature	-15°C -15°C	-15°C -15°C
En büyük sürekli uygulama ve tesisat sıcaklığı Maximum continuous application and installation temperature	+60°C +60°C	+60°C +60°C
Bükülmeye karşı dayanıklılık Flexural Strength	Esnek - kendini toparlayan Flexible-Self recovering	Esnek - kendini toparlayan Flexible-Self recovering
Dış etkenlere karşı dayanıklılık Resistance to external impacts	Katı yabancı cisimlerin girişine karşı korumalı Protected against ingress of solid foreign materials	Katı yabancı cisimlerin girişine karşı korumalı Protected against ingress of solid foreign materials
Alev yayılmasına karşı dayanıklılık Resistance to flame propagation	Alev yaymayan Non-flame-propagating	Alev yayan Flammable

POLYAMİD (PA) ALEV YAYMAYAN SİRALLER POLYAMIDE (PA) NON-FLAME-PROPAGATING SPIRALS

Boru tipi Type of the Pipe	Metalik olmayan - oluklu Nonmetallic - Corrugated
Bağlantı metodu Connection method	Diş çekilmemiş Non-threaded
Sıkıştırmaya karşı dayanıklılık Compressive Strength	Hafif (320 N) Low (320 N)
Darbeye karşı dayanıklılık Impact Resistance	Hafif (1kg, 100 mm) -15°C'de Low (1 kg, 100 mm) - 15°C
En küçük sürekli uygulama ve tesisat sıcaklığı Minimum continuous application and installation temperature	-15°C -15°C
En büyük sürekli uygulama ve tesisat sıcaklığı Maximum continuous application and installation temperature	+105°C +105°C
Bükülmeye karşı dayanıklılık Flexural Strength	Esnek - kendini toparlayan Flexible-Self recovering
Dış etkenlere karşı dayanıklılık Resistance to external impacts	Katı yabancı cisimlerin girişine karşı korumalı Protected against ingress of solid foreign materials
Alev yayılmasına karşı dayanıklılık Resistance to flame propagation	Alev yaymayan Non-flame-propagating

POLİPROPİLEN (PP) SİRALLER POLYPROPYLENE (PP) FLAMMABLE SPIRALS

Boru tipi Type of the Pipe	Metalik olmayan - oluklu Nonmetallic - Corrugated
Bağlantı metodu Connection method	Diş çekilmemiş Non-threaded
Sıkıştırmaya karşı dayanıklılık Compressive Strength	Hafif (320 N) Low (320 N)
Darbeye karşı dayanıklılık Impact Resistance	Hafif (1kg, 100 mm) -15°C'de Low (1 kg, 100 mm) - 15°C
En küçük sürekli uygulama ve tesisat sıcaklığı Minimum continuous application and installation temperature	-15°C -15°C
En büyük sürekli uygulama ve tesisat sıcaklığı Maximum continuous application and installation temperature	+90°C +90°C
Bükülmeye karşı dayanıklılık Flexural Strength	Esnek - kendini toparlayan Flexible-Self recovering
Dış etkenlere karşı dayanıklılık Resistance to external impacts	Katı yabancı cisimlerin girişine karşı korumalı Protected against ingress of solid foreign materials
Alev yayılmasına karşı dayanıklılık Resistance to flame propagation	Alev Yayan Flammable

RİJİT BORULAR RIGID PIPES

Boru tipi Type of the Pipe	Metalik olmayan Nonmetallic
Bağlantı metodu Connection method	Diş çekilmemiş Non-threaded
Sıkıştırmaya karşı dayanıklılık Compressive Strength	H.FREE RİJİT BORULAR Hafif (320 N) Orta (750 N) Ağır (1250 N) RİJİT BORULAR Orta (750 N) H.FREE RIGID PIPES Low (320 N) Medium (750 N) Heavy (1250 N) RIGID PIPES Medium (750 N)
Darbeye karşı dayanıklılık Impact Resistance	Orta (2 Kg, 100 mm) -15°C'de Medium (2 Kg, 100 mm) - 15°C
En küçük sürekli uygulama ve tesisat sıcaklığı Minimum continuous application and installation temperature	-15°C -15°C
En büyük sürekli uygulama ve tesisat sıcaklığı Maximum continuous application and installation temperature	+60°C +60°C
Bükülmeye karşı dayanıklılık Flexural Strength	Rijit Rigid
Dış etkenlere karşı dayanıklılık Resistance to external impacts	Katı yabancı cisimlerin girişine karşı korumalı Protected against ingress of solid foreign materials
Alev yayılmasına karşı dayanıklılık Resistance to flame propagation	Alev yaymayan borular Nonflammable

H.FREE ALEV YAYAN DÜZ ELEKTRİK TESİSAT BORULARI H.FREE FLAME-PROPAGATING PLAIN ELECTRICAL INSTALLATION PIPE

Boru tipi Type of the Pipe	Metalik olmayan Nonmetallic
Bağlantı metodu Connection method	Diş çekilmemiş Non-threaded
Sıkıştırmaya karşı dayanıklılık Compressive Strength	SİBOR SERİSİ Çok Hafif (125 N) Hafif (320 N) MEKS SERİSİ Hafif (320 N) Orta (750 N) Ağır (1250 N) SİBOR SERIES Very Low (125 N) Low (320 N) MEKS SERIES Low (320 N) Medium (750 N) Heavy (1250 N)
Darbeye karşı dayanıklılık Impact Resistance	Orta (2 Kg, 100 mm) -15°C'de Medium (2 Kg, 100 mm) - 15°C
En küçük sürekli uygulama ve tesisat sıcaklığı Minimum continuous application and installation temperature	-15°C -15°C
En büyük sürekli uygulama ve tesisat sıcaklığı Maximum continuous application and installation temperature	+60°C +60°C
Bükülmeye karşı dayanıklılık Flexural Strength	Esnek - kendini toparlayan Flexible-Self recovering
Dış etkenlere karşı dayanıklılık Resistance to external impacts	Katı yabancı cisimlerin girişine karşı korumalı Protected against ingress of solid foreign materials
Alev yayılmasına karşı dayanıklılık Resistance to flame propagation	Alev yayan Flammable

H.FREE ALEV YAYMAYAN DÜZ ELEKTRİK TESİSAT BORULARI H.FREE NON-FLAME-PROPAGATING PLAIN ELECTRICAL INSTALLATION PIPE

Boru tipi Type	Metalik olmayan Nonmetallic - Corrugated
Bağlantı metodu Connection type	Diş çekilmemiş Non-threaded
Sıkıştırmaya karşı dayanıklılık External load resistance	SİBOR SERİSİ Çok Hafif (125 N) Hafif (320 N) MEKS SERİSİ Hafif (320 N) Orta (750 N) Ağır (1250 N) SİBOR SERIES Very Low (125 N) Low (320 N) MEKS SERIES Low (320 N) Medium (750 N) Heavy (1250 N)
Darbeye karşı dayanıklılık Impact resistance	Orta (2 Kg, 100 mm) -15°C'de Medium (2 Kg, 100 mm) - 15°C
En küçük sürekli uygulama ve tesisat sıcaklığı Starting and installation temperature minimum	-15°C -15°C
En büyük sürekli uygulama ve tesisat sıcaklığı Starting and installation temperature maximum	+60°C +60°C
Bükülmeye karşı dayanıklılık Resistance for stiffnes	Esnek - kendini toparlayan Flexible-Self recovering
Dış etkenlere karşı dayanıklılık Resistance to external materials	Katı yabancı cisimlerin girişine karşı korumalı Protected against ingress of solid foreign materials
Alev yayılmasına karşı dayanıklılık Resistance to fire	Alev yaymayan Nonflammable

ÇELİK SİRİRAL EKO / MEKS STEEL SPIRALS EKO / MEKS

Boru tipi Type of the Pipe	Metalik - Oluklu Metallic - Corrugated
Bağlantı metodu Connection method	Dış çekilmemiş Non-threaded
Sıkıştırmaya karşı dayanıklılık Compressive Strength	Hafif (320 N) Low (320 N)
Darbeye karşı dayanıklılık Impact Resistance	Hafif (1kg, 100 mm) Low (1 kg, 100 mm)
En küçük sürekli uygulama ve tesisat sıcaklığı Minimum continuous application and installation temperature	-15°C -15°C
En büyük sürekli uygulama ve tesisat sıcaklığı Maximum continuous application and installation temperature	+60 +60
Bükülmeye karşı dayanıklılık Flexural Strength	Esnek Flexible
Dış etkenlere karşı dayanıklılık Resistance to external impacts	Katı yabancı cisimlerin girişine karşı korumalı Protected against ingress of solid foreign materials
Alev yayılmasına karşı dayanıklılık Resistance to flame propagation	Alev yaymayan Non-flame-propagating

İZOLELİ ÇELİK SİRİRAL EKO / MEKS INSULATED STEEL SPIRALS EKO / MEKS

Boru tipi Type of the Pipe	Kompozit - Oluklu Composite - Corrugated
Bağlantı metodu Connection method	Dış çekilmemiş Non-threaded
Sıkıştırmaya karşı dayanıklılık Compressive Strength	Hafif (320 N) Low (320 N)
Darbeye karşı dayanıklılık Impact Resistance	Hafif (1kg, 100 mm) Low (1 kg, 100 mm)
En küçük sürekli uygulama ve tesisat sıcaklığı Minimum continuous application and installation temperature	-15°C -15°C
En büyük sürekli uygulama ve tesisat sıcaklığı Maximum continuous application and installation temperature	+60 +60
Bükülmeye karşı dayanıklılık Flexural Strength	Esnek Flexible
Dış etkenlere karşı dayanıklılık Resistance to external impacts	Katı yabancı cisimlerin girişine karşı korumalı Protected against ingress of solid foreign materials
Alev yayılmasına karşı dayanıklılık Resistance to flame propagation	Alev yaymayan Non-flame-propagating

PVC ALEV YAYMAYAN SİRİRAL PVC SPIRALS FLAME - PROPAGATING

Boru tipi Type of the Pipe	Metalik olmayan - Oluklu Non-Metallic - Corrugated
Bağlantı metodu Connection method	Dış çekilmemiş Non-threaded
Sıkıştırmaya karşı dayanıklılık Compressive Strength	Hafif (320 N) Orta (750 N) Low (320 N) Medium (750 N)
Darbeye karşı dayanıklılık Impact Resistance	Orta (2 kg / 100 mm) Medium (2 kg / 100 mm)
En küçük sürekli uygulama ve tesisat sıcaklığı Minimum continuous application and installation temperature	-15°C -15°C
En büyük sürekli uygulama ve tesisat sıcaklığı Maximum continuous application and installation temperature	+60 +60
Bükülmeye karşı dayanıklılık Flexural Strength	Esnek Flexible
Dış etkenlere karşı dayanıklılık Resistance to external impacts	Katı yabancı cisimlerin girişine karşı korumalı Protected against ingress of solid foreign materials
Alev yayılmasına karşı dayanıklılık Resistance to flame propagation	Alev yaymayan Non-flame-propagating

ÇELİK SİRALLER

STEEL SPIRALS

	Kod Code	İç Çap Inner Diameter	Dış Çap Outer Diameter	Kod Code	İç Çap Inner Diameter	Dış Çap Outer Diameter
EKO SERİSİ ÇELİK SİRALLER ECO SERIES STEEL SPIRALS				ÇELİK SİRALLER STEEL SPIRALS		
	001 054 150009 00 66	9 mm	12,10 mm	 001 054 120009 00 66	9 mm	12,10 mm
	001 054 150011 00 66	11 mm	14,10 mm	 001 054 120011 00 66	11 mm	14,10 mm
	001 054 150014 00 66	14 mm	17,10 mm	 001 054 120014 00 66	14 mm	17,10 mm
	001 054 150016 00 66	16 mm	19,10 mm	 001 054 120016 00 66	16 mm	19,10 mm
	001 054 150018 00 66	18 mm	21,10 mm	 001 054 120018 00 66	18 mm	21,10 mm
	001 054 150021 00 66	21 mm	24,10 mm	 001 054 120026 00 66	26 mm	29,10 mm
	001 054 150026 00 66	26 mm	29,10 mm	 001 054 120029 00 66	29 mm	32,10 mm
	001 054 150029 00 66	29 mm	32,10 mm	001 054 120032 00 66	32 mm	35,10 mm
	001 054 150032 00 66	32 mm	35,10 mm	 001 054 120037 00 66	37 mm	41,10 mm
	001 054 150037 00 66	37 mm	41,10 mm	 001 054 120042 00 66	42 mm	45,10 mm
	001 054 150042 00 66	42 mm	45,10 mm	 001 054 120050 00 66	50 mm	53,10 mm
	001 054 150050 00 66	50 mm	53,10 mm	001 054 120063 00 66	63 mm	66,10 mm

EKO SERİSİ ÇELİK SİRALLER İÇTEN TELLİ

ECO SERIES STEEL SPIRALS WITH INTERNAL WIRE

ÇELİK SİRALLER İÇTEN TELLİ

STEEL SPIRALS WITH INTERNAL WIRE

	001 054 221009 00 66	9 mm	12,10 mm	001 054 121009 00 66	9 mm	12,10 mm
	001 054 221011 00 66	11 mm	14,10 mm	001 054 121011 00 66	11 mm	14,10 mm
	001 054 221014 00 66	14 mm	17,10 mm	001 054 121014 00 66	14 mm	17,10 mm
	001 054 221016 00 66	16 mm	19,10 mm	001 054 121016 00 66	16 mm	19,10 mm
	001 054 221018 00 66	18 mm	21,10 mm	001 054 121018 00 66	18 mm	21,10 mm
	001 054 221021 00 66	21 mm	24,10 mm	001 054 121026 00 66	26 mm	29,10 mm
	001 054 221026 00 66	26 mm	29,10 mm	001 054 121029 00 66	29 mm	32,10 mm
	001 054 221029 00 66	29 mm	32,10 mm	001 054 121032 00 66	32 mm	35,10 mm
	001 054 221032 00 66	32 mm	35,10 mm	001 054 121037 00 66	37 mm	41,10 mm
	001 054 221037 00 66	37 mm	41,10 mm	001 054 121042 00 66	42 mm	45,10 mm
	001 054 221042 00 66	42 mm	45,10 mm	001 054 121050 00 66	50 mm	53,10 mm
	001 054 221050 00 66	50 mm	53,10 mm	001 054 121063 00 66	63 mm	66,10 mm

PVC İZOLELİ SPİRALLER

PVC INSULATED SPIRALS

	Kod Code	İç Çap Inner Diameter	Dış Çap Outer Diameter	Kod Code	İç Çap Inner Diameter	Dış Çap Outer Diameter	
	001 054 160009 00 11	9 mm	13,20 mm		001 054 130009 00 11	9 mm	13,20 mm
	001 054 160011 00 11	11 mm	15,20 mm		001 054 130011 00 11	11 mm	15,20 mm
	001 054 160014 00 11	14 mm	18,40 mm		001 054 130014 00 11	14 mm	18,40 mm
	001 054 160016 00 11	16 mm	20,40 mm		001 054 130016 00 11	16 mm	20,40 mm
	001 054 160018 00 11	18 mm	22,40 mm		001 054 130018 00 11	18 mm	22,40 mm
	001 054 160021 00 11	21 mm	25,40 mm		001 054 130026 00 11	26 mm	30,40 mm
	001 054 160026 00 11	26 mm	30,40 mm		001 054 130029 00 11	29 mm	33,40 mm
	001 054 160029 00 11	29 mm	33,40 mm		001 054 130032 00 11	32 mm	36,40 mm
	001 054 160032 00 11	32 mm	36,40 mm		001 054 130037 00 11	37 mm	42,40 mm
	001 054 160037 00 11	37 mm	42,40 mm		001 054 130042 00 11	42 mm	46,40 mm
	001 054 160042 00 11	42 mm	46,40 mm		001 054 130050 00 11	50 mm	54,40 mm
	001 054 160050 00 11	50 mm	54,40 mm		001 054 130063 00 11	63 mm	67,20 mm

EKO SERİSİ İZOLELİ ÇELİK SPİRALLER İÇTEN TELLİ

ECO SERIES INSULATED STEEL SPIRALS WITH INTERNAL WIRE

İZOLELİ ÇELİK SPİRALLER İÇTEN TELLİ

INSULATED STEEL SPIRALS WITH INTERNAL WIRE

	001 054 231009 00 11	9 mm	13,20 mm	001 054 140009 00 11	9 mm	13,20 mm
	001 054 231011 00 11	11 mm	15,20 mm	001 054 140011 00 11	11 mm	15,20 mm
	001 054 231014 00 11	14 mm	18,40 mm	001 054 140014 00 11	14 mm	18,40 mm
	001 054 231016 00 11	16 mm	20,40 mm	001 054 140016 00 11	16 mm	20,40 mm
	001 054 231018 00 11	18 mm	22,40 mm	001 054 140018 00 11	18 mm	22,40 mm
	001 054 231021 00 11	21 mm	25,40 mm	001 054 140026 00 11	26 mm	30,40 mm
	001 054 231026 00 11	26 mm	30,40 mm	001 054 140029 00 11	29 mm	33,40 mm
	001 054 231029 00 11	29 mm	33,40 mm	001 054 140032 00 11	32 mm	36,40 mm
	001 054 231032 00 11	32 mm	36,40 mm	001 054 140037 00 11	37 mm	42,40 mm
	001 054 231037 00 11	37 mm	42,40 mm	001 054 140042 00 11	42 mm	46,40 mm
	001 054 231042 00 11	42 mm	46,40 mm	001 054 140050 00 11	50 mm	54,40 mm
	001 054 231050 00 11	50 mm	54,40 mm	001 054 140063 00 11	63 mm	67,20 mm

PVC SPİRALLER

PVC SPIRALS

	Kod Code	İç Çap Inner Diameter	Dış Çap Outer Diameter
--	-------------	--------------------------	---------------------------

PVC ALEV YAYMAYAN SPİRALLER (FLEXI MEKS) 750 N

PVC NON-FLAME-PROPAGATING SPIRALS (FLEXI MEKS) 750 N

	001 020 000016 00 17	11,20 mm	15,85 mm
	001 020 000020 00 17	14,40 mm	19,85 mm
	001 020 000025 00 17	18,10 mm	24,80 mm
	001 020 000032 00 17	25,90 mm	31,80 mm

PVC ALEV YAYMAYAN KLAVUZ TELLİ SPİRALLER (FLEXI MEKS) 750 N

PVC NON-FLAME-PROPAGATING SPIRALS WITH GUIDE WIRE (FLEXI MEKS) 750 N

	001 020 100016 00 17	11,20 mm	15,85 mm
	001 020 100020 00 17	14,40 mm	19,85 mm
	001 020 100025 00 17	18,10 mm	24,80 mm
	001 020 100032 00 17	25,90 mm	31,80 mm

PVC ALEV YAYMAYAN SPİRALLER (FLEXI MEKS) 320 N

PVC NON-FLAME-PROPAGATING SPIRALS (FLEXI MEKS) 320 N

	001 020 010016 00 17	11,20 mm	15,85 mm
	001 020 010020 00 17	14,40 mm	19,85 mm
	001 020 010025 00 17	18,10 mm	24,80 mm
	001 020 010032 00 17	25,90 mm	31,80 mm

PVC ALEV YAYMAYAN KLAVUZ TELLİ SPİRALLER (FLEXI MEKS) 320 N

PVC NON-FLAME-PROPAGATING SPIRALS WITH GUIDE WIRE (FLEXI MEKS) 320 N

	001 020 120016 00 17	11,20 mm	15,85 mm
	001 020 120020 00 17	14,40 mm	19,85 mm
	001 020 120025 00 17	18,10 mm	24,80 mm
	001 020 120032 00 17	25,90 mm	31,80 mm



HALOJEN FREE SİRALLER 320 N

HALOGEN-FREE SPIRALS 320 N

	Kod Code	İç Çap Inner Diameter	Dış Çap Outer Diameter
--	-------------	--------------------------	---------------------------



HALOJEN FREE SİRAL ALEV YAYAN 320 N

HALOGEN FREE SPIRALS (FLAME-PROPAGATING) 320 N

  	001 020 140016 00 12	11,20 mm	15,85 mm
	001 020 140020 00 12	14,40 mm	19,85 mm
	001 020 140025 00 12	18,10 mm	24,80 mm
	001 020 140032 00 12	25,90 mm	31,80 mm
	001 020 140040 00 12		
	001 020 140050 00 12		

HALOJEN FREE SİRAL ALEV YAYAN KILAVUZ TELLİ 320 N

HALOGEN FREE SPIRALS (FLAME-PROPAGATING) WITH GUIDE WIRE 320 N

  	001 020 141016 00 12	11,20 mm	15,85 mm
	001 020 141020 00 12	14,40 mm	19,85 mm
	001 020 141025 00 12	18,10 mm	24,80 mm
	001 020 141032 00 12	25,90 mm	31,80 mm
	001 020 141040 00 12		
	001 020 141050 00 12		

HALOJEN FREE SİRAL ALEV YAYMAYAN 320 N

HALOGEN FREE SPIRALS (NON-FLAME-PROPAGATING) 320 N

  	001 020 150016 00 17	11,20 mm	15,85 mm
	001 020 150020 00 17	14,40 mm	19,85 mm
	001 020 150025 00 17	18,10 mm	24,80 mm
	001 020 150032 00 17	25,90 mm	31,80 mm
	001 020 150040 00 17		
	001 020 150050 00 17		

HALOJEN FREE SİRAL ALEV YAYMAYAN KILAVUZ TELLİ 320 N

HALOGEN FREE SPIRALS (NON-FLAME-PROPAGATING) WITH GUIDE WIRE 320 N

  	001 020 151016 00 17	11,20 mm	15,85 mm
	001 020 151020 00 17	14,40 mm	19,85 mm
	001 020 151025 00 17	18,10 mm	24,80 mm
	001 020 151032 00 17	25,90 mm	31,80 mm
	001 020 151040 00 17		
	001 020 151050 00 17		

HALOJEN FREE SİRALLER 750 N

HALOGEN-FREE SPIRALS 750 N

	Kod Code	İç Çap Inner Diameter	Dış Çap Outer Diameter
--	-------------	--------------------------	---------------------------



HALOJEN FREE SİRAL ALEV YAYAN 750 N

HALOGEN FREE SPIRALS (FLAME-PROPAGATING) 750 N

  	001 020 740016 00 12	10.3 mm	15,85 mm
	001 020 740020 00 12	14.5 mm	19,85 mm
	001 020 740025 00 12	18.7 mm	24,80 mm
	001 020 740032 00 12	24.2 mm	31,80 mm

HALOJEN FREE SİRAL ALEV YAYAN KILAVUZ TELLİ 750 N

HALOGEN FREE SPIRALS (FLAME-PROPAGATING) WITH GUIDE WIRE 750 N

  	001 020 741016 00 12	10.3 mm	15,85 mm
	001 020 741020 00 12	14.5 mm	19,85 mm
	001 020 741025 00 12	18.7 mm	24,80 mm
	001 020 741032 00 12	24.2 mm	31,80 mm

HALOJEN FREE SİRAL ALEV YAYMAYAN 750 N

HALOGEN FREE SPIRALS (NON-FLAME-PROPAGATING) 750 N

  	001 020 750016 00 17	10.3 mm	15,85 mm
	001 020 750020 00 17	14.5 mm	19,85 mm
	001 020 750025 00 17	18.7 mm	24,80 mm
	001 020 750032 00 17	24.2 mm	31,80 mm

HALOJEN FREE SİRAL ALEV YAYMAYAN KILAVUZ TELLİ 750 N

HALOGEN FREE SPIRALS (NON-FLAME-PROPAGATING) WITH GUIDE WIRE 750 N

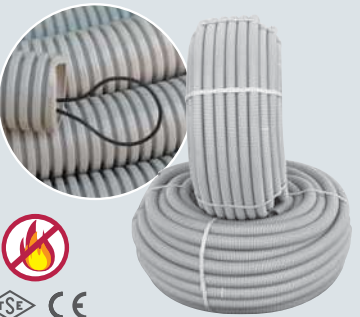
  	001 020 751016 00 17	10.3 mm	15,85 mm
	001 020 751020 00 17	14.5 mm	19,85 mm
	001 020 751025 00 17	18.7 mm	24,80 mm
	001 020 751032 00 17	24.2 mm	31,80 mm

HALOJEN FREE SİRALLER 1250 N

HALOGEN-FREE SPIRALS 1250 N

	Kod Code	İç Çap Inner Diameter	Dış Çap Outer Diameter
--	-------------	--------------------------	---------------------------



HALOJEN FREE SİRAL ALEV YAYAN 1250 N

HALOGEN FREE SPIRALS (FLAME-PROPAGATING) 1250 N

  	001 020 240016 00 12	10.0 mm	15,85 mm
	001 020 240020 00 12	14.0 mm	19,85 mm
	001 020 240025 00 12	18.4 mm	24,80 mm
	001 020 240032 00 12	24.0 mm	31,80 mm

HALOJEN FREE SİRAL ALEV YAYAN KILAVUZ TELLİ 1250 N

HALOGEN FREE SPIRALS (FLAME-PROPAGATING) WITH GUIDE WIRE 1250 N

  	001 020 241016 00 12	10.0 mm	15,85 mm
	001 020 241020 00 12	14.0 mm	19,85 mm
	001 020 241025 00 12	18.4 mm	24,80 mm
	001 020 241032 00 12	24.0 mm	31,80 mm

HALOJEN FREE SİRAL ALEV YAYMAYAN 1250 N

HALOGEN FREE SPIRALS (NON-FLAME-PROPAGATING) 1250 N

  	001 020 250016 00 17	10.0 mm	15,85 mm
	001 020 250020 00 17	14.0 mm	19,85 mm
	001 020 250025 00 17	18.4 mm	24,80 mm
	001 020 250032 00 17	24.0 mm	31,80 mm

HALOJEN FREE SİRAL ALEV YAYMAYAN KILAVUZ TELLİ 1250 N

HALOGEN FREE SPIRALS (NON-FLAME-PROPAGATING) WITH GUIDE WIRE 1250 N

  	001 020 251016 00 17	10.0 mm	15,85 mm
	001 020 251020 00 17	14.0 mm	19,85 mm
	001 020 251025 00 17	18.4 mm	24,80 mm
	001 020 251032 00 17	24.0 mm	31,80 mm

PLASTİK SİRİRAL BORULAR

PLASTIC SPIRAL PIPES

	Kod Code	İç Çap Inner Diameter	Dış Çap Outer Diameter
--	-------------	--------------------------	---------------------------

PLASTİK SİRİRALER

PLASTIC SPIRALS



001 020 400014 00 11	15,60 mm	19,05 mm
001 020 400016 00 11	11,20 mm	15,85 mm
001 020 400018 00 11	19,60 mm	24 mm
001 020 400020 00 11	14,40 mm	19,85 mm
001 020 400026 00 11	26,10 mm	30,75 mm
001 020 400032 00 11	25,90 mm	31,80 mm
001 020 400040 00 11	36 mm	39,80 mm
001 020 400050 00 11	45,50 mm	49,75 mm

PLASTİK SİRİRALER KLAVUZ TELLİ

PLASTIC SPIRAL WITH GUIDE WIRE



001 020 410014 00 11	15,60 mm	19,05 mm
001 020 410016 00 11	11,20 mm	15,85 mm
001 020 410018 00 11	19,60 mm	24 mm
001 020 410020 00 11	14,40 mm	19,85 mm
001 020 410026 00 11	26,10 mm	30,75 mm
001 020 410032 00 11	25,90 mm	31,80 mm
001 020 410040 00 11	36 mm	39,80 mm
001 020 410050 00 11	45,50 mm	49,75 mm

POLYAMİD SİRİRALER

POLYAMIDE SPIRALS

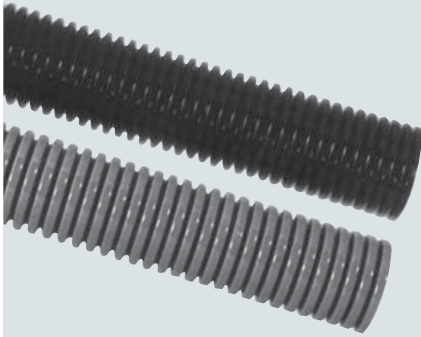

001 020 170007 00 17	7 mm	10,10 mm
001 020 170009 00 17	8,50 mm	12 mm
001 020 170010 00 17	10,20 mm	13,10 mm
001 020 170012 00 17	12,30 mm	15,90 mm
001 020 170014 00 17	14,10 mm	18,35 mm
001 020 170017 00 17	17 mm	21,50 mm
001 020 170019 00 17	19 mm	24,25 mm
001 020 170023 00 17	23 mm	28,70 mm
001 020 170026 00 17	26,20 mm	31,30 mm
001 020 170029 00 17	29,10 mm	34,30 mm
001 020 170036 00 17	35,75 mm	42,20 mm
001 020 170048 00 17	48,50 mm	54,50 mm

POLİPROPİLEN SİRİRALER

POLYPROPYLENE SPIRALS

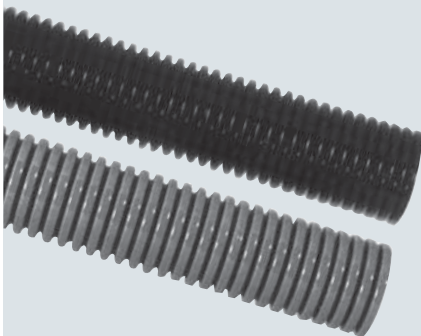

001 020 160007 00 17	6,50 mm	10 mm
001 020 160009 00 17	8,50 mm	12 mm
001 020 160010 00 17	10 mm	13 mm
001 020 160012 00 17	12 mm	16 mm
001 020 160014 00 17	14 mm	18,50 mm
001 020 160017 00 17	17 mm	21,50 mm
001 020 160019 00 17	19 mm	24 mm
001 020 160023 00 17	23 mm	28,70 mm
001 020 160026 00 17	26 mm	31 mm
001 020 160029 00 17	29 mm	34,5 mm
001 020 160036 00 17	36 mm	42,5 mm
001 020 160048 00 17	48 mm	54,5 mm

PLASTİK SPİRAL BORU AKSESUARLARI

PLASTIC SPIRAL PIPES ACCESSORIES

	Kod Code	İç Çap Inner Diameter	Dış Çap Outer Diameter
KABLO TOPLAMA SPİRALİ CABLE ORGANIZER SPIRAL			
	888 020 900001	10 mm	
	888 020 900002	16 mm	Aksesuar
	888 020 900003	16 mm	
	888 020 900004	16 mm	
	888 020 900005	22 mm	
	888 020 900006	22 mm	Aksesuar
	888 020 900007	22 mm	
	888 020 900008	28 mm	Aksesuar
	888 020 900009	28 mm	
	888 020 900010	28 mm	
	888 020 900011	34 mm	

SPİRAL BİRLEŞTİRİCİ

SPIRAL COUPLER

	001 020 990016 00 17	16 mm	
	001 020 990020 00 17	20 mm	
	001 020 990025 00 17	25 mm	
	001 020 990032 00 17	32 mm	

HELEZON PANO SPİRALİ

HELICOID PANEL SPIRAL

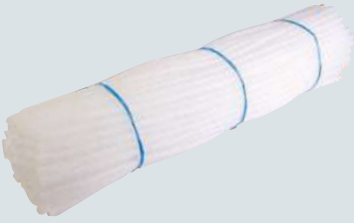
	Ürün Adı Product Name	Boy Size	Adet Quantity
	001 020 500000 05 00	No:0	50 cm
	001 020 500001 05 00	No:1	50 cm
	001 020 500002 05 00	No:2	50 cm
	001 020 500003 05 00	No:3	50 cm
	001 020 500004 05 00	No:4	50 cm
	001 020 500005 05 00	No:5	50 cm

HELEZON PANO SPİRALİ (RULO)

HELICOID PANEL SPIRAL (ROLL)

	Ürün Adı Product Name	Adet Boyu Quantity Size
	001 020 600001 00 00	No:1
	001 020 600002 00 00	No:2
	001 020 600003 00 00	No:3
	001 020 600004 00 00	No:4
	001 020 600005 00 00	No:5

HAZIR SİRALLİ KABLolar

PREWIRED ELECTRO CONDUITS

	Kod Code	Kablo Kesiti mm ² Cable Dimension mm ²	Spiral Özellik Spiral Specification	Spiral Çap (mm) Spiral Diameter (mm)
--	-------------	---	--	---

SİRALLİ ENERJİ KABLolarI

SPIRALS ENERGY CABLES

H07V-U (NYA) KABLolar

H07V-U (NYA) ENERGY CABLES

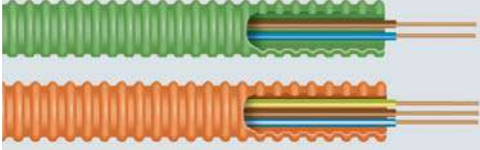
	122 050 215014	2x1.5	HF-PE	14
	122 050 315014	3x1.5	HF-PE	14
	122 050 415016	4x1.5	HF-PE	16
	122 050 225014	2x2.5	HF-PE	14
	122 050 325016	3x2.5	HF-PE	16
	122 050 425020	4x2.5	HF-PE	20

H07V-U (NYA) KABLolar HALOGEN FREE



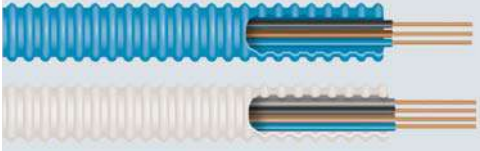

H07V-U (NYA) ENERGY CABLES HALOGEN FREE



	122 051 215014	2x1.5	HF-PE	14
	122 051 315014	3x1.5	HF-PE	14
	122 051 415016	4x1.5	HF-PE	16
	122 051 225014	2x2.5	HF-PE	14
	122 051 325016	3x2.5	HF-PE	16
	122 051 425020	4x2.5	HF-PE	20

SİRALLİ ZAYIF AKIM KABLolarI

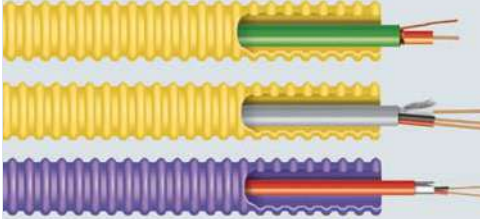
SPIRALS LOW CURRENT CABLES

	DATA KABLolarI DATA CABLES			
	122 052 100516	U / UTP CAT5e	HF-PE	16
	122 052 100616	U / UTP CAT6e	HF-PE	16
	KOAKSİYEL KABLolar TV CABLES			
	122 052 200214	RG 59/U2 (cu/AL)	HF-PE	14
	122 052 200416	RG 6/U4 (cu/AL)	HF-PE	16
	122 052 200616	RG 6/U6 (cu/AL)	HF-PE	16
	CCTV KAMERA KABLolarI CCTV CAMERA CABLES			
	122 052 301214	CCTV 1+2 (2x0.22mm ²)	HF-PE	14
	122 052 301416	CCTV 1+4 (2x2x0.22mm ²)	HF-PE	16
	JY (st) Y YANGIN İHBAR KABLolarI JY (st) Y FIRE SYSTEM CABLES			
	122 052 401216	JY(st)Y 1x2x0.80+40 mm ²	HF-PE	16
	122 052 402216	JY(st)Y 2x2x0.80+40 mm ²	HF-PE	16
	122 052 404216	JY(st)Y 4x2x0.80+40 mm ²	HF-PE	20
	DİYAFON KABLolarI INTERCOM CABLES			
	122 052 502216	DT-8 8x0.22 mm ²	HF-PE	16

HAZIR SİRALLİ KABLolar

PREWIRED ELECTRO CONDUITS

Kod
CodeKablo Kesiti mm²
Cable Dimension mm²Spiral Özellik
Spiral SpecificationSpiral Çap (mm)
Spiral Diameter (mm)

SİRALLİ ZAYIF AKIM KABLolar HALOGEN FREE

SPIRALS LOW CURRENT CABLES HALOGEN FREE



(LSZH) DATA KABLolar HALOGEN FREE

(LSZH) DATA CABLES HALOGEN FREE

122 053 100516	U / UTP CAT5e (4x2x24 AWG)	HF-PE	16
122 053 100616	U / UTP CAT6 (4x2x23 AWG)	HF-PE	16



(PHY-HF) KOAKSİYEL KABLolar HALOGEN FREE

(PHY-HF) TV CABLES HALOGEN FREE

122 053 200416	RG 59/U2 (cu/AL)	HF-PE	16
122 052 200616	RG 6/U4 (cu/AL)	HF-PE	16

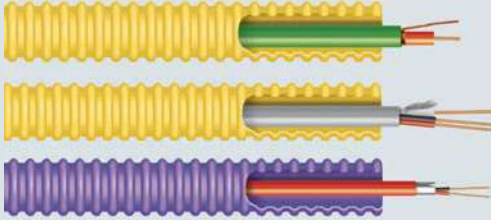

CCTV KAMERA KABLolar HALOGEN FREE

CCTV CAMERA CABLES HALOGEN FREE

122 052 301214	CCTV 1+2 (2x0.22mm ²)	HF-PE	14
122 052 301416	CCTV 1+4 (2x2x0.22mm ²)	HF-PE	16



JY (st) Y YANGIN İHBAR KABLolar HALOGEN FREE

JY (st) Y FIRE SYSTEM HALOGEN FREE

122 052 401216	JY(st)Y 1x2x0.80+40 mm ²	HF-PE	16
122 052 402216	JY(st)Y 2x2x0.80+40 mm ²	HF-PE	16
122 052 404216	JY(st)Y 4x2x0.80+40 mm ²	HF-PE	20



LIHH DİYAFON KABLolar HALOGEN FREE

(LIHH) INTERCOM CABLES HALOGEN FREE

122 052 502216	DT-8 8x0.22 mm ²	HF-PE	16
----------------	-----------------------------	-------	----

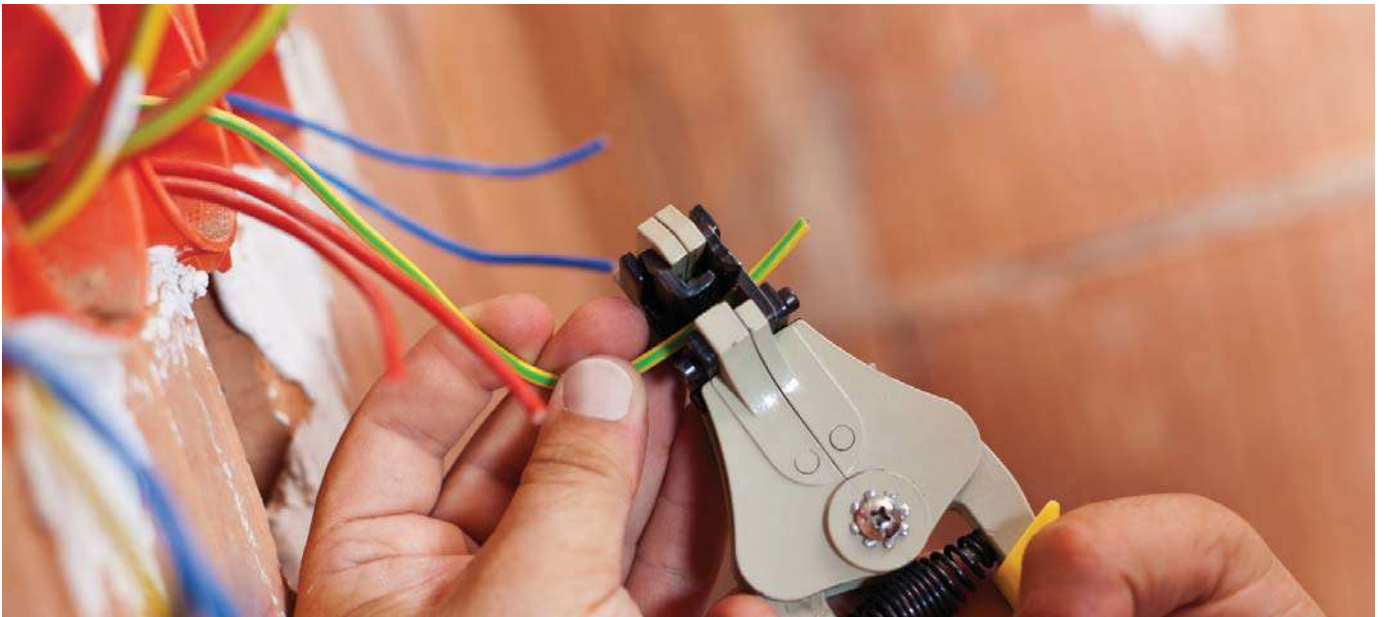

HALOJEN FREE RİJİT ALEV YAYMAYAN BORULAR

HALOGEN FREE NON-FLAME-PROPAGATING RIJIT PIPES

	Kod Code	İç Çap Inner Diameter	Dış Çap (+0,-0.3) Outer Diameter
--	-------------	--------------------------	-------------------------------------

HALOJEN FREE ALEV YAYMAYAN BORULAR - 320 N

HALOGEN FREE NON-FLAME-PROPAGATING PIPES - 320 N

    	001 045 500016 30 17	12.4 mm	16 mm
	001 045 500020 30 17	16.6 mm	20 mm
	001 045 500025 30 17	20.6 mm	25 mm
	001 045 500032 30 17	28.8 mm	32 mm
	001 045 500040 30 17	36.7 mm	40 mm
	001 045 500050 30 17	42.9 mm	50 mm

HALOJEN FREE ALEV YAYMAYAN BORULAR - 750 N

HALOGEN FREE NON-FLAME-PROPAGATING PIPES - 750 N

    	001 045 510016 30 17	12.4 mm	16 mm
	001 045 510020 30 17	16.0 mm	20 mm
	001 045 510025 30 17	20.6 mm	25 mm
	001 045 510032 30 17	26.8 mm	32 mm
	001 045 510040 30 17	33.9 mm	40 mm
	001 045 510050 30 17	42.9 mm	50 mm

HALOJEN FREE ALEV YAYMAYAN BORULAR - 1250 N

HALOGEN FREE NON-FLAME-PROPAGATING PIPES - 1250 N

    	001 045 520016 30 17	12.1 mm	16 mm
	001 045 520020 30 17	15.2 mm	20 mm
	001 045 520025 30 17	20.0 mm	25 mm
	001 045 520032 30 17	25.9 mm	32 mm
	001 045 520040 30 17	32.3 mm	40 mm
	001 045 520050 30 17	42.0 mm	50 mm



PVC ALEV YAYMAYAN BORULAR

PVC NON-FLAME-PROPAGATING PIPES

	Kod Code	İç Çap Inner Diameter	Dış Çap (+0,-0.3) Outer Diameter
--	-------------	--------------------------	-------------------------------------

PVC KENDİNDEN MUFLU ALEV YAYMAYAN BORULAR 750 N

PVC SELF FITTING NON FLAME PROPAGATING PIPES 750 N

	001 045 110014 30 17	11,80 mm	14 mm
	 CE 001 045 110016 30 17	12,80 mm	15,90 mm
	001 045 110018 30 17	15,50 mm	18 mm
	 CE 001 045 110020 30 17	16,70 mm	19,90 mm
	 CE 001 045 110025 30 17	21,90 mm	24,80 mm
	 CE 001 045 110032 30 17	29 mm	31,89mm
	001 045 110040 30 17	37,40 mm	39,89 mm

DİRSEKLER

BRACKETS

	CE 001 051 010014 00 17	14 mm	18 mm
	 CE 001 051 010016 00 17	16 mm	20 mm
	CE 001 051 010018 00 17	18 mm	22 mm
	 CE 001 051 010020 00 17	20 mm	24 mm
	 CE 001 051 010025 00 17	25 mm	29 mm
	 CE 001 051 010032 00 17	32 mm	36 mm

MUFLAR

COUPLER FITTING

	CE 001 051 030014 00 17	14 mm	18 mm
	 CE 001 051 030016 00 17	16 mm	20 mm
	CE 001 051 030018 00 17	18 mm	22 mm
	 CE 001 051 030020 00 17	20 mm	24 mm
	 CE 001 051 030025 00 17	25 mm	29 mm
	 CE 001 051 030032 00 17	32 mm	36 mm

PVC ALEV YAYMAYAN BORULAR 750 N

PVC NON-FLAME-PROPAGATING PIPES 750 N

	001 045 120014 30 17	11,80 mm	14 mm
	 CE 001 045 120016 30 17	12,80 mm	16 mm
	001 045 120018 30 17	16,50 mm	18 mm
	 CE 001 045 120020 30 17	16,70 mm	20 mm
	 CE 001 045 120025 30 17	21,90 mm	25 mm
	 CE 001 045 120032 30 17	29 mm	32 mm
	 CE 001 045 120040 30 17	37,40 mm	40 mm

SİBOR SERİSİ HALOJEN FREE TURUNCU BORULAR

SIBOR SERIES HALOGEN FREE ORANGE PIPES

	Kod Code	İç Çap Inner Diameter	Dış Çap (+0,-0.3) Outer Diameter
--	-------------	--------------------------	-------------------------------------

SİBOR SERİSİ 6 ATÜ ALEV YAYAN 125 N

SIBOR SERIES 6 ATU FLAME-PROPAGATING 125 N



001 165 706014 00 12	10.4 mm	14 mm
001 165 706016 00 12	12.4 mm	16 mm
001 165 706018 00 12	14.6 mm	18 mm
001 165 706020 00 12	16.6 mm	20 mm
001 165 706025 00 12	20.6 mm	25 mm
001 165 706032 00 12	28.8 mm	32 mm
001 165 706037 00 12	33.6 mm	37 mm
001 165 706040 00 12	36.7 mm	40 mm
001 165 706050 00 12	42.9 mm	50 mm

SİBOR SERİSİ 6 ATÜ ALEV YAYMAYAN 125 N

SIBOR SERIES 6 ATU NON-FLAME-PROPAGATING 125 N



001 165 206014 00 12	10.4 mm	14 mm
001 165 206016 00 12	12.4 mm	16 mm
001 165 206018 00 12	14.6 mm	18 mm
001 165 206020 00 12	16.6 mm	20 mm
001 165 206025 00 12	20.6 mm	25 mm
001 165 206032 00 12	28.8 mm	32 mm
001 165 206037 00 12	33.6 mm	37 mm
001 165 206040 00 12	36.7 mm	40 mm
001 165 206050 00 12	42.9 mm	50 mm

SİBOR SERİSİ 10 ATÜ ALEV YAYAN 320 N

SIBOR SERIES 10 ATU FLAME-PROPAGATING 320 N



001 165 710014 00 12	9.4 mm	14 mm
001 165 710016 00 12	12.4 mm	16 mm
001 165 710018 00 12	13.6 mm	18 mm
001 165 710020 00 12	16.0 mm	20 mm
001 165 710025 00 12	20.6 mm	25 mm
001 165 710032 00 12	26.8 mm	32 mm
001 165 710037 00 12	33.6 mm	37 mm
001 165 710040 00 12	33.9 mm	40 mm
001 165 710050 00 12	42.9 mm	50 mm

SİBOR SERİSİ 10 ATÜ ALEV YAYMAYAN 320 N























SIBOR SERIES 10 ATU NON-FLAME-PROPAGATING 320 N



001 165 210014 00 12	9.4 mm	14 mm
001 165 210016 00 12	12.4 mm	16 mm
001 165 210018 00 12	13.6 mm	18 mm
001 165 210020 00 12	16.0 mm	20 mm
001 165 210025 00 12	20.6 mm	25 mm
001 165 210032 00 12	26.8 mm	32 mm
001 165 210037 00 12	33.6 mm	37 mm
001 165 210040 00 12	33.9 mm	40 mm
001 165 210050 00 12	42.9 mm	50 mm

POLİETİLEN HALOJEN FREE BORULAR

POLYETHYLENE HALOGEN-FREE PIPES

	Kod Code	İç Çap Inner Diameter	Dış Çap Outer Diameter	
6 ATÜ ALEV YAYAN - 320 N 6 ATU FLAME-PROPAGATING - 320 N				
  	001 165 506014 00 12	11,25 mm	14,50 mm	
	 001 165 506016 00 12	12,65 mm	15,85 mm	
	001 165 506018 00 12	14,60 mm	18 mm	
	 001 165 506020 00 12	16,45 mm	19,85 mm	
	 001 165 506025 00 12	20,80 mm	24,80 mm	
	 001 165 506032 00 12	26,80 mm	31,80 mm	
	001 165 506037 00 12	30,80 mm	36,80 mm	
	 001 165 506040 00 12	33,90 mm	39,80 mm	
	 001 165 506050 00 12	42,90 mm	49,75 mm	
	 001 165 506063 00 12	55,30 mm	62,70 mm	
	 001 165 506075 00 12	66 mm	74,70 mm	
	001 165 506090 00 12	81,80 mm	90,85 mm	
	10 ATÜ ALEV YAYAN - 750 N 10 ATU FLAME-PROPAGATING - 750 N			
	  	001 165 510014 00 12	10,70 mm	14,45 mm
 001 165 510016 00 12		12 mm	15,85 mm	
001 165 510018 00 12		14,60 mm	18 mm	
 001 165 510020 00 12		15,15 mm	19,85 mm	
 001 165 510025 00 12		19,80 mm	24,80 mm	
 001 165 510032 00 12		25,25 mm	31,80 mm	
001 165 510037 00 12		29,50 mm	36,80 mm	
 001 165 510040 00 12		32,30 mm	39,80 mm	
 001 165 510050 00 12		42 mm	49,75 mm	
 001 165 510063 00 12		52,90 mm	62,70 mm	
 001 165 510075 00 12		64,30 mm	74,70 mm	
001 165 510090 00 12		78,80 mm	90,85 mm	
001 165 510100 00 12		89,90 mm	100,95 mm	
001 165 510110 00 12		95 mm	111 mm	

POLİETİLEN HALOJEN FREE BORULAR

POLYETHYLENE HALOGEN-FREE PIPES

	Kod Code	İç Çap Inner Diameter	Dış Çap Outer Diameter
--	-------------	--------------------------	---------------------------

6 ATÜ ALEV YAYMAYAN - 320 N

6 ATU NON-FLAME-PROPAGATING - 320 N



	001 165 106014 00 12	11,25 mm	14,50 mm
	001 165 106016 00 12	12,65 mm	15,85 mm
	001 165 106018 00 12	14,60 mm	18 mm
	001 165 106020 00 12	16,45 mm	19,85 mm
	001 165 106025 00 12	20,80 mm	24,80 mm
	001 165 106032 00 12	26,80 mm	31,80 mm
	001 165 106037 00 12	30,80 mm	36,80 mm
	001 165 106040 00 12	33,90 mm	39,80 mm
	001 165 106050 00 12	42,90 mm	49,75 mm
	001 165 106063 00 12	55,30 mm	62,70 mm
	001 165 106075 00 12	66 mm	74,70 mm
	001 165 106090 00 12	81,80 mm	90,85 mm

10 ATÜ ALEV YAYMAYAN - 750 N











10 ATU NON-FLAME-PROPAGATING - 750 N



	001 165 110014 00 12	10,70 mm	14,45 mm
	001 165 110016 00 12	12 mm	15,85 mm
	001 165 110018 00 12	14,60 mm	18 mm
	001 165 110020 00 12	15,15 mm	19,85 mm
	001 165 110025 00 12	19,80 mm	24,80 mm
	001 165 110032 00 12	25,25 mm	31,80 mm
	001 165 110037 00 12	29,50 mm	36,80 mm
	001 165 110040 00 12	32,30 mm	39,80 mm
	001 165 110050 00 12	42 mm	49,75 mm
	001 165 110063 00 12	52,90 mm	62,70 mm
	001 165 110075 00 12	64,30 mm	74,70 mm
	001 165 110090 00 12	78,80 mm	90,85 mm
	001 165 110100 00 12	89,90 mm	100,95 mm
	001 165 110110 00 12	95 mm	111 mm

POLİETİLEN HALOJEN FREE BORULAR

POLYETHYLENE HALOGEN-FREE PIPES









	Kod Code	İç Çap Inner Diameter	Dış Çap Outer Diameter
ALEV YAYAN - 1250 N FLAME-PROPAGATING - 1250 N			
  	001 165 512014 00 12	9,25 mm	14,50 mm
	 001 165 512016 00 12	10,70 mm	15,85 mm
	001 165 512018 00 12	12,60 mm	18 mm
	 001 165 512020 00 12	14,50 mm	19,85 mm
	 001 165 512025 00 12	18,00 mm	24,80 mm
	 001 165 512032 00 12	25,80 mm	31,80 mm
	001 165 512037 00 12	30,80 mm	36,80 mm
	 001 165 512040 00 12	33,90 mm	39,80 mm
	 001 165 512050 00 12	43,50 mm	49,75 mm
	 001 165 512063 00 12	52,90 mm	62,70 mm
	 001 165 512075 00 12	64,30 mm	74,70 mm
	001 165 512090 00 12	79,80 mm	90,00 mm

ALEV YAYMAYAN - 1250 N NON-FLAME-PROPAGATING - 1250 N			
   	001 165 112014 00 12	9,25 mm	14,45 mm
	 001 165 112016 00 12	10,70 mm	15,85 mm
	001 165 112018 00 12	12,60 mm	18 mm
	 001 165 112020 00 12	14,50 mm	19,85 mm
	 001 165 112025 00 12	18,00 mm	24,80 mm
	 001 165 112032 00 12	25,80 mm	31,80 mm
	001 165 112037 00 12	30,80 mm	36,80 mm
	 001 165 112040 00 12	33,90 mm	39,80 mm
	 001 165 112050 00 12	43,50 mm	49,75 mm
	 001 165 112063 00 12	52,90 mm	62,70 mm
	 001 165 112075 00 12	64,30 mm	74,70 mm
	001 165 112090 00 12	79,80 mm	90,00 mm

POLİETİLEN SİYAH BORULAR

POLYETHYLENE BLACK PIPES

	Kod Code	İç Çap Inner Diameter	Dış Çap Outer Diameter
6 ATÜ 450 N 6 ATU 450 N			
	001 165 406014 00 11	11,50 mm	14,65 mm
	001 165 406016 00 11	12,75 mm	15,85 mm
	001 165 406018 00 11	14,70 mm	18,10 mm
	001 165 406020 00 11	16,25 mm	19,85 mm
	 CE 001 165 406025 00 11	20,79 mm	24,80 mm
	 CE 001 165 406032 00 11	26,80 mm	31,80 mm
	001 165 406037 00 11	30,75 mm	36,80 mm
	 CE 001 165 406040 00 11	33,90 mm	39,80 mm
	 CE 001 165 406050 00 11	42,90 mm	49,75 mm
	 CE 001 165 406063 00 11	55,30 mm	62,70 mm
	 CE 001 165 406075 00 11	66 mm	74,70 mm
	 CE 001 165 406090 00 11	81,80 mm	90,85 mm

10 ATÜ 750 N 10 ATU 750 N			
	001 165 410014 00 11	10,50 mm	14,45mm
	001 165 410016 00 11	12 mm	15,85 mm
	001 165 410018 00 11	14,30 mm	18,10 mm
	001 165 410020 00 11	15,30 mm	19,85 mm
	 CE 001 165 410025 00 11	19,80 mm	24,80 mm
	 CE 001 165 410032 00 11	25,80 mm	31,80 mm
	001 165 410037 00 11	29,50 mm	36,80 mm
	 CE 001 165 410040 00 11	32,30 mm	39,80 mm
	 CE 001 165 410050 00 11	42 mm	49,75 mm
	 CE 001 165 410063 00 11	52,90 mm	62,70 mm
	 CE 001 165 410075 00 11	64,30 mm	74,70 mm
	 CE 001 165 410090 00 11	78,80 mm	90,85 mm
	001 165 410100 00 11	89,90 mm	100,95 mm
 CE 001 165 410110 00 11	95 mm	111 mm	

PLASTİK BORULAR

PLASTIC PIPES

	001 045 000014 30 00	14 mm Kalın Boy Boru	14 mm Thick Pipes
	001 045 000018 30 00	18 mm Kalın Boy Boru	18 mm Thick Pipes
	001 045 000026 30 00	26 mm Kalın Boy Boru	26 mm Thick Pipes
	001 045 000037 30 00	37 mm Kalın Boy Boru	37 mm Thick Pipes
	001 045 010014 00 11	14 mm Kagal (Normal)	14 mm Coil (Normal)
	001 045 010018 00 11	18 mm Kagal (Normal)	18 mm Coil (Normal)
	001 045 010026 00 11	26 mm Kagal (Normal)	26 mm Coil (Normal)
	001 045 010037 00 11	37 mm Kagal (Normal)	37 mm Coil (Normal)

KAUÇUK BORULAR

RUBBER PIPES

	001 045 020014 00 00	14 mm Kagal (Kauçuk)	14 mm Coil (Rubber)
	001 045 020018 00 00	18 mm Kagal (Kauçuk)	18 mm Coil (Rubber)
	001 045 020026 00 00	26 mm Kagal (Kauçuk)	26 mm Coil (Rubber)
	001 045 020037 00 00	37 mm Kagal (Kauçuk)	37 mm Coil (Rubber)
	001 045 030014 00 00	14 mm Kagal (Kauçuk) (Kalın)	14 mm Coil (Rubber) (Thick)
	001 045 030018 00 00	18 mm Kagal (Kauçuk) (Kalın)	18 mm Coil (Rubber) (Thick)

SUSTALAR VE BUAT KAPAKLARI

CABLE PULLERS AND JUNCTION BOX COVERS

	Kod Code	Açıklama Description	Ambalaj Packing	Adet Quantity	Ağırlık Weight	Hacim Volume
--	-------------	-------------------------	--------------------	------------------	-------------------	-----------------

LÜX BUAT KAPAKLARI

LUX JUNCTION BOX COVERS

	126 046 180002	Lüx Buat Kapağı (Sac Ayak) Bombeli Lux Junction Box Cover (Sheet Trivet) Curved	Kutu Pack	500	8.5 Kg	0.195
	126 046 180003	Lüx Buat Kapağı (Plastik Ayak) Düz Lux Junction Box Cover (Plastic Trivet) Flat	Kutu Pack	500	6 Kg	0.195
	126 046 180004	L. B. K. (Bombeli - Pls. Ayak) Demir Vidalı 1. Kalite Lux Junction Box Cover (Curved-Plastic Trivet) Iron Screw, Premium Quality	Kutu Pack	500	7.5 Kg	0.195
	126 046 180001	Lüx Buat Kapağı (Bombeli-Plastik Ayak) Lux Junction Box Cover (Curved-Plastic Trivet)	Kutu Pack	500	6 Kg	0.195

PVC İZOLE KAPLI ÇELİK SUSTA

PVC INSULATION COATED STEEL CABLE PULLER

	049 019 300010	PVC İzole Kaplı Çelik Susta 10 mt PVC Insulation Coated Steel Cable Puller 10 m	Kutu Pack	-	-	-
	049 019 300015	PVC İzole Kaplı Çelik Susta 15 mt PVC Insulation Coated Steel Cable Puller 15 m	Kutu Pack	-	-	-
	049 019 300020	PVC İzole Kaplı Çelik Susta 20 mt PVC Insulation Coated Steel Cable Puller 20 m	Kutu Pack	-	-	-
	049 019 300025	PVC İzole Kaplı Çelik Susta 25 mt PVC Insulation Coated Steel Cable Puller 25 m	Kutu Pack	-	-	-

PLASTİK SUSTA (KLAUZ TELLİ)

PLASTIC CABLE PULLER (WITH GUIDE WIRE)

	049 019 400010	Takviyeli Plastik Susta 10 mt Plastic Cable Puller (with guide wire) 10 mt	Kutu Pack	-	-	-
	049 019 400015	Takviyeli Plastik Susta 15 mt Plastic Cable Puller (with guide wire) 15 mt	Kutu Pack	-	-	-
	049 019 400020	Takviyeli Plastik Susta 20 mt Plastic Cable Puller (with guide wire) 20 mt	Kutu Pack	-	-	-
	049 019 400025	Takviyeli Plastik Susta 25 mt Plastic Cable Puller (with guide wire) 25 mt	Kutu Pack	-	-	-

ÇELİK SUSTA

STEEL CABLE PULLER

	001 019 000010 00 00	1.Kalite 10 mt'lik Susta Premium Quality Cable Puller, 10 m	Kutu Pack	40	27.60 Kg	0.025
	001 019 000015 00 00	1.Kalite 15 mt'lik Susta Premium Quality Cable Puller, 15 m	Kutu Pack	30	31.08 Kg	0.025
	001 019 000020 00 00	1.Kalite 20 mt'lik Susta Premium Quality Cable Puller, 20 m	Kutu Pack	20	27.56 Kg	0.025
	001 019 000025 00 00	1.Kalite 25 mt'lik Susta Premium Quality Cable Puller, 25 m	Kutu Pack	15	25.8 Kg	0.025
	001 019 100010 00 00	1. Kalite 10 mt'lik Tak. Susta Premium Quality Cable Puller, 10 m, Reinforced	Kutu Pack	40	28.64 Kg	0.025
	001 019 100015 00 00	1. Kalite 15 mt'lik Tak. Susta Premium Quality Cable Puller, 15 m, Reinforced	Kutu Pack	30	31.98 Kg	0.025
	001 019 100020 00 00	1. Kalite 20 mt'lik Tak. Susta Premium Quality Cable Puller, 20 m, Reinforced	Kutu Pack	20	28.36 Kg	0.025
	001 019 100025 00 00	1. Kalite 25 mt'lik Tak. Susta Premium Quality Cable Puller, 25 m, Reinforced	Kutu Pack	15	26.55 Kg	0.025
	001 018 000001 00 00	Florasın Zinciri Fluorescent Chain	Kutu Pack	500 m	20.50 Kg	0.017

BETON DUVAR KASALARI

CONCRETE WALL CASINGS

	Kod Code	Açıklama Description	Ambalaj Packing	Adet Quantity	Ağırlık Weight	Hacim Volume
	000 700 200037 00 14   	Buat Arka Kapak (Sarı) Junction Box Back Cover (Yellow)	Kutu Pack	500	6 Kg	0.018
	000 700 000037 00 14					
	000 700 200035 00 12   	Buat Gövde 60'lık (Turuncu) Junction Box Body, 60 mm (Orange)	Kutu Pack	350	9.45 Kg	0.130
	000 700 000035 00 12					
	000 700 200256 00 14   	Kalıba Tespit Elemanı (Sarı) Die Fixing Tool (Orange)	Kutu Pack	250	4.09 Kg	0.65
	000 700 000256 00 14					
	000 700 200039 00 12   	Sığ Brüt Anahtar Kasası (Turuncu) Shallow Gross Switch Case (Orange)	Kutu Pack	500	12.53 Kg	0.130
	000 700 000039 00 12					
	000 700 200036 00 14  	Konik Gövde (Sarı) Conical Body (Yellow)	Kutu Pack	250	4.63 Kg.	0.034
	000 700 000036 00 14					
	000 700 200214 00 14   	Aplik 20'lik (Sarı) Bracket Lamp, 20 mm (Yellow)	Kutu Pack	1000	4.34 Kg	0.029
	000 700 000214 00 14					
	000 700 200215 00 12   	Aplik Eğik Bağlantı Dirseği (Turuncu) Bracket Lamp Scarf Joint Bracket (Orange)	Kutu Pack	1000	3.54 Kg	0.039
	000 700 000215 00 12					



PLASTİK KASA VE BUATLAR

PLASTIC CASINGS AND JUNCTION BOXES

	Kod Code	Açıklama Description
--	-------------	-------------------------

TURUNCU BUAT VE KASALAR

ORANGE JUNCTION BOXES AND CASINGS

	001 046 131102 00 12	Norm Kasa Norm Casing
	001 046 130102 00 12	
	001 046 131101 00 12	Norm Buat Ø14 Ø18 Çıkışlı Norm Junction Box (with Ø14, Ø18 Outlets)
	001 046 130101 00 12	
	001 046 161102 00 12	Geçmeli Plastik Kasa Click-Fit Plastic Casing
	001 046 160102 00 12	
	001 046 161101 00 12	Geçmeli Derin Kasa Click-Fit Deep Casing
	001 046 160101 00 12	
	001 046 121100 00 12	Geçmeli Alçıpan Kasa Click-Fit Drywall Casing
	001 046 120100 00 12	
	000 700 100160 00 12	Geçmeli Derin Kasa Gövde Click-Fit Deep Casing Body
	000 700 000160 00 12	
	000 700 100073 00 12	Geçmeli Derin Kasa Kapak Click-Fit Deep Casing Cover
	000 700 000073 00 12	
	001 046 121101 00 12	Alçıpan Kasa 1'li Drywall Casing, Single
001 046 120101 00 12		
001 046 121102 00 12	Alçıpan Kasa 2'li Drywall Casing, Double	
001 046 120102 00 12		
001 046 121103 00 12	Alçıpan Kasa 3'lü Drywall Casing, Triple	
001 046 120103 00 12		
001 046 210002 00 12	Tünel Kasa Tunnel Casing	
001 046 170101 00 12		
001 046 210003 00 12	Tünel Buat Tunnel Junction Box	
001 046 170102 00 12		

SİYAH BUAT VE KASALAR

BLACK JUNCTION BOXES AND CASINGS

	126 046 130103	Norm Kasa Norm Casing
	126 046 130104	Norm Buat Ø14 Ø18 Çıkışlı Norm Junction Box (with Ø14, Ø18 Outlets)
	001 046 160102 00 00	Geçmeli Plastik Kasa Click-Fit Plastic Casing
	126 046 130106	Geçmeli Derin Kasa Click-Fit Deep Casing
	001 046 120100 00 11	Geçmeli Alçıpan Kasa Click-Fit Drywall Casing
	001 046 120101 00 11	Alçıpan Kasa 1'li Drywall Casing, Single
	001 046 120102 00 11	Alçıpan Kasa 2'li Drywall Casing, Double
	001 046 120103 00 11	Alçıpan Kasa 3'lü Drywall Casing, Triple
	001 046 170101 00 11	Tünel Kasa Tunnel Casing
	001 046 170102 00 11	Tünel Buat Tunnel Junction Box

PLASTİK DİRSEKLER

PLASTIC BRACKETS

	127 051 000014	Plastik Ø14 Dirsek Plastic Bracket, Ø14
	127 051 000018	Plastik Ø18 Dirsek Plastic Bracket, Ø18
	127 051 000026	Plastik Ø26 Dirsek Plastic Bracket, Ø26

PLASTİK MUFLAR

PLASTIC PIPE SOCKETS

	001 051 020014 00 11	Plastik Ø14 Muf Plastic Pipe Socket, Ø14
	001 051 020018 00 11	Plastik Ø18 Muf Plastic Pipe Socket, Ø18
	001 051 020026 00 11	Plastik Ø26 Muf Plastic Pipe Socket, Ø26
	001 051 020037 00 11	Plastik Ø37 Muf Plastic Pipe Socket, Ø37
	001 046 000001 00 11	Plastik Takoz (Ø14 Ø18 Çıkışlı) Plastic Cleat (with Ø14, Ø18 Outlets)
	047 109 010013	Anahtar Altı (Desenli) Switch Casings (Patterned)

KROŞELER

CABLE STRAPS

	Kod Code	Açıklama Description	Ambalaj Packing	Adet Quantity	Ağırlık Weight	Hacim Volume
--	-------------	-------------------------	--------------------	------------------	-------------------	-----------------

ANTİGRON BORU KROŞELERİ

ANTIGRÓN PIPE STRAPS

	001 048 010016 00 17	16'lik Antigrón Boru Kroşesi Antigrón Pipe Straps, Ø16	Kutu Pack	100	0.35 Kg	0.002
	001 048 010018 00 17	18'lik Antigrón Boru Kroşesi Antigrón Pipe Straps, Ø18	Kutu Pack	100	0.40 Kg	0.003
	001 048 010020 00 17	20'lik Antigrón Boru Kroşesi Antigrón Pipe Straps, Ø20	Kutu Pack	100	0.42 Kg	0.004
	001 048 010022 00 17	22'lik Antigrón Boru Kroşesi Antigrón Pipe Straps, Ø22	Kutu Pack	-	-	-
	001 048 010025 00 17	25'lik Antigrón Boru Kroşesi Antigrón Pipe Straps, Ø25	Kutu Pack	100	0.55 Kg	0.004
	001 048 010027 00 17	27'lik Antigrón Boru Kroşesi Antigrón Pipe Straps, Ø27	Kutu Pack	-	-	-
	001 048 010032 00 17	32'lik Antigrón Boru Kroşesi Antigrón Pipe Straps, Ø32	Kutu Pack	50	0.33 Kg	0.004
	001 048 010040 00 17	40'lik Antigrón Boru Kroşesi Antigrón Pipe Straps, Ø40	Kutu Pack	100	1.60 Kg	0.026

DÜBELLİ KROŞELER

CABLE STRAPS WITH DOWEL

	001 048 090002 00 17	3/13 Tekli Kablo Kroşesi 3/13 Single Cable Strap	Kutu Pack	500	0.250 Kg	-
	001 048 090006 00 17	8/28 Tekli Kablo Kroşesi 8/28 Single Cable Strap	Kutu Pack	500	0.500 Kg	-
	001 048 090003 00 17	16'lik Dübelli Boru Kroşesi Tekli Pipe Crochet with Ø16 Dowel, Single	Kutu Pack	5000	9.85 Kg	0.516
	001 048 090004 00 17	20'lik Dübelli Boru Kroşesi Tekli Pipe Crochet with Ø20 Dowel, Single	Kutu Pack	5000	13.56 Kg	0.755
	001 048 090005 00 17	25'lik Dübelli Boru Kroşesi Tekli Pipe Crochet with Ø25 Dowel, Single	Kutu Pack	3000	13.42 Kg	0.753

MUTLUSAN BETON ÇİVİLİ KROŞELER

MUTLUSAN CABLE STRAPS WITH CONCRETE NAIL

	032 048 070000	No.0 Beton Çivili Kroşe 0.75 Yassı Kord. Kroşe No. 0 Cable Strap with Concrete Nail 0.75 Flat Cord Cable Strap	Kutu Pack	30000	17.7 Kg	0.028
	032 048 070001	No.1 Beton Çivili Kroşe 0.75 Yassı Kord. Kroşe No. 1 Cable Strap with Concrete Nail 0.75 Flat Cord Cable Strap	Kutu Pack	30000	15.86 Kg	0.028
	032 048 070002	No.2 Beton Çivili Kroşe 0.75 Yassı Kord. Kroşe No. 2 Cable Strap with Concrete Nail 0.75 Flat Cord Cable Strap	Kutu Pack	20000	19.40 Kg	0.028
	032 048 070003	No.3 Beton Çivili Kroşe (2x1.5-3x1.5) No. 3 Cable Strap with Concrete Nail (2x1.5 - 3x1.5)	Kutu Pack	20000	24.62 Kg	0.060
	032 048 070004	No.4 Beton Çivili Kroşe (2x4) No.4 Cable Strap with Concrete Nail (2x4)	Kutu Pack	20000	26.44 Kg	0.060
	032 048 070005	No.5 Beton Çivili Kroşe (2x4-4x4) No. 5 Cable Strap with Concrete Nail (2x4-4x4)	Kutu Pack	10000	19 Kg	0.053
	032 048 070006	No.6 Beton Çivili Kroşe (2x6) No. 6 Cable Strap with Concrete Nail (2x6)	Kutu Pack	10000	23.87 Kg	0.055
	032 048 070007	No.7 Beton Çivili Kroşe (4x10) No. 7 Cable Strap with Concrete Nail (4x10)	Kutu Pack	8000	20.66 Kg	0.045
	032 048 070008	No.8 Beton Çivili Kroşe (3x16+10) No. 8 Cable Strap with Concrete Nail (3x26+10)	Kutu Pack	5000	25.70 Kg	0.070
	032 048 070009	No.9 Beton Çivili Kroşe (3x25+16) No. 9 Cable Strap with Concrete Nail (3x25+16)	Kutu Pack	5000	31 Kg	0.090

KROŞELER CABLE STRAPS

	Kod Code	Açıklama Description	Ambalaj Packing	Adet Quantity	Ağırlık Weight	Hacim Volume
--	-------------	-------------------------	--------------------	------------------	-------------------	-----------------

TANDIR KROŞELER METALLIC CABLE STRAPS

	035 048 110001	No.1 Tandır Kroşe (2x1.5-2x6) No. 1 Metallic Cable Straps	Kutu Pack	350	3.87 Kg	0.0027
	035 048 110002	No.2 Tandır Kroşe (4x6) No. 2 Metallic Cable Straps	Kutu Pack	250	2.17 Kg	0.0027
	035 048 110003	No.3 Tandır Kroşe (4x10) No. 3 Metallic Cable Straps	Kutu Pack	-	2.65 Kg	0.0027
	035 048 110004	No.4 Tandır Kroşe (4x16) No. 4 Metallic Cable Straps	Kutu Pack	150	2.11 Kg	0.0027
	035 048 110005	No.5 Tandır Kroşe (3x25+16) No. 5 Metallic Cable Straps	Kutu Pack	150	2.21 Kg	0.0027

RAY KROŞELER RAIL CABLE STRAPS

	035 048 100001	No.1 Ray Kroşe (2x1.5-4x2.5) No. 1 Rail Cable Straps	Kutu Pack	350	2.34 Kg	0.0057
	035 048 100002	No.2 Ray Kroşe (4x4-4x16) No. 2 Rail Cable Straps	Kutu Pack	250	2.14 Kg	0.0057
	001 025 010100 00 00	Galvaniz Ray Kroşe Galvanized Rail Cable Straps	Kutu Pack	50	12.5 Kg	0.013

ANTİGRON KROŞELER ANTIGRAN CABLE STRAPS

	128 048 000001	No.1 (2x1.5-2x2.5-3x1.5-3x2.5)	Kutu Pack	2000	10.58 Kg	0.081
	128 048 000015	No.1.5 (2x4-2x6-4x4-4x6)	Kutu Pack	1500	9.33 Kg	0.061
	128 048 000002	No.2 (4x10)	Kutu Pack	1250	11.11 Kg	0.051
	128 048 000003	No.3 (4x16-3x25+16)	Kutu Pack	750	-	-

GALVANİZ SAC KROŞELER GALVANIZED SHEET CABLE STRAPS

	001 048 060001 00 00	No.1 Tekli No. 1 Single	Ø 10 mm	Kutu Pack	1500	6.6 Kg	0.006
	001 048 060002 00 00	No.2 Tekli No. 2 Single	Ø 14 mm	Kutu Pack	1000	6 Kg	0.006
	001 048 060003 00 00	No.3 Tekli No. 3 Single	Ø 16 mm	Kutu Pack	700	5.11 Kg	0.006
	001 048 060004 00 00	No.4 Tekli No. 4 Single	Ø 20 mm	Kutu Pack	500	4.25 Kg	0.006
	001 048 060007 00 00	No.7 Tekli No. 7 Single	Ø 25 mm	Kutu Pack	350	3.82 Kg	0.006
	001 048 060008 00 00	No.8 Tekli No. 8 Single	Ø 40 mm	Kutu Pack	250	3.28 Kg	0.006
	001 048 060009 00 00	No.9 Tekli No. 9 Single	Ø 45.5 mm	Kutu Pack	200	2.98 Kg	0.006
	001 048 060010 00 00	No.10 Tekli No. 10 Single	Ø 50.5 mm	Kutu Pack	150	2.31 Kg	0.006
	001 048 070002 00 00	No.2 Çiftli No. 2 Double	Ø 13 mm	Kutu Pack	600	4.75 Kg	0.006
	001 048 070003 00 00	No.3 Çiftli No. 3 Double	Ø 15.5 mm	Kutu Pack	500	4.18 Kg	0.006
	001 048 070004 00 00	No.4 Çiftli No. 4 Double	Ø 22 mm	Kutu Pack	400	3.70 Kg	0.006
001 048 070007 00 00	No.7 Çiftli No. 7 Double	Ø 26 mm	Kutu Pack	400	4.92 Kg	0.008	
001 048 070008 00 00	No.8 Çiftli No. 8 Double	Ø 33 mm	Kutu Pack	300	4.09 Kg	0.008	
001 048 070009 00 00	No.9 Çiftli No. 9 Double	Ø 44 mm	Kutu Pack	200	3.43 Kg	0.008	
001 048 070010 00 00	No.10 Çiftli No. 10 Double	Ø 48 mm	Kutu Pack	150	2.84 Kg	0.008	
001 048 070011 00 00	No.11 Çiftli No. 11 Double	Ø 55.5 mm	Kutu Pack	100	2.08 Kg	0.008	

PLASTİK DÜBELLER

PLASTIC DOWELS

	Kod Code	Açıklama Description	Ambalaj Packing	Adet Quantity	Ağırlık Weight	Hacim Volume
	016 053 000014	Burgulu Alçıpan Dübeli Twisted Drywall Dowel	Kutu Pack	-	-	-
	016 053 308100	8x100mm Boşluk Dübeli 8x100mm Spacer Dowel	Kutu Pack	5000	15 Kg	0.07
	016 053 100002	Mega Dübel Mega Dowel	Kutu Pack	500	0.78 Kg	-
	001 053 000001 00 00	Alçıpan Dübeli Drywall Dowel	Kutu Pack	250	0.33 Kg	0.003
	001 053 000002 00 00	Kanal Dübeli Trunking Dowel	Kutu Pack	500	0.60 Kg	0.003
	001 053 000003 00 00	Dübeli Kablo Bağı Vidası Cable Tie Screw with Dowel	Kutu Pack	100	0.12 Kg	0.002
	001 053 000013 00 00	Dübeli Kablo Bağı 20 cm Cable Tie with Dowel, 20 cm	Kutu Pack	-	-	-
	001 053 000004 00 00	Dübeli Kablo Bağı 15 cm Cable Tie with Dowel, 15 cm	Kutu Pack	-	-	-
	001 053 000005 00 00	Korniş Dübeli Curtain Rod Dowel	Kutu Pack	500	0.60 Kg	0.003
	016 053 000006	6 mm Beyaz Dübél 6 mm Dowel, White	Kutu Pack	1	0.0004 Kg	0.000002
	016 053 000007	7 mm Beyaz Dübél 7 mm Dowel, White	Kutu Pack	25000	15 Kg	0.05
	016 053 000008	8 mm Beyaz Dübél 8 mm Dowel, White	Kutu Pack	20000	18 Kg	0.06
	016 053 000010	10 mm Beyaz Dübél 10 mm Dowel, White	Kutu Pack	10000	18 Kg	0.07
	016 053 000012	12 mm Beyaz Dübél 12 mm Dowel, White	Kutu Pack	250	0.3 Kg	0.0025
	016 053 000106	6 mm Renkli Dübél (Yeşil) 6 mm Colored Dowel (Green)	Kutu Pack	1000	1.2 Kg	0.002
	016 053 000107	7 mm Renkli Dübél (Sarı) 7 mm Colored Dowel (Yellow)	Kutu Pack	1000	1.2 Kg	0.002
	016 053 000108	8 mm Renkli Dübél (Kırmızı) 8 mm Colored Dowel (Red)	Kutu Pack	1000	1.2 Kg	0.002
	016 053 000110	10 mm Renkli Dübél (Mavi) 10 mm Colored Dowel (Blue)	Kutu Pack	500	0.6 Kg	0.0025
	016 053 300008	8 mm Roket Dübél 8 mm Rocket Dowel	Kutu Pack	1000	1.2 Kg	0.002
	016 053 300010	10 mm Roket Dübél 10 mm Rocket Dowel	Kutu Pack	5000	6 Kg	-

ASPIRATÖR FANS



100 mm 001 111 000100 00 00

Çalışma Akımı
Operation Voltage 220-240V / 50-60Hz

Emiş Hacmi
Airflow 100m³/h

Devir Hız
Round Speed 2250 rpm

Güç
Power 12W

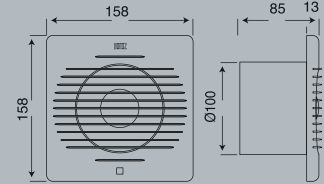

120 mm 001 111 000120 00 00

Çalışma Akımı
Operation Voltage 220-240V / 50-60Hz

Emiş Hacmi
Airflow 120m³/h

Devir Hız
Round Speed 1900 rpm

Güç
Power 15W

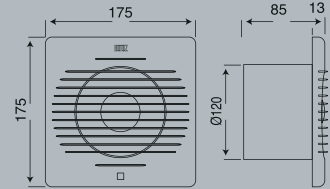

150 mm 001 111 000150 00 00

Çalışma Akımı
Operation Voltage 220-240V / 50-60Hz

Emiş Hacmi
Airflow 150m³/h

Devir Hız
Round Speed 1800 rpm

Güç
Power 20W

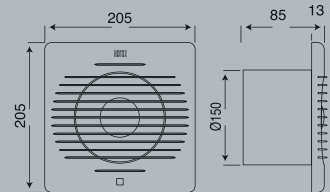

200 mm 001 111 000200 00 00

Çalışma Akımı
Operation Voltage 220-240V / 50-60Hz

Emiş Hacmi
Airflow 200m³/h

Devir Hız
Round Speed 2000 rpm

Güç
Power 40W

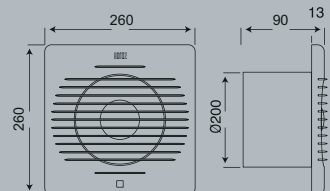



AYDINLATMA GRUBU
LIGHTING GROUP



OSRAM LED ve PHILIPS DRIVER kullanılmıştır.
We use OSRAM LED ve PHILIPS DRIVER

SLIMLED

LED Panel Aydınlatma
LED PANEL Lighting

Ürün Kodu / Product Code

006 087 00 XXXX 60x60 Sıvaltı Panel - Recessed Mounted Panel

- | | | |
|---|-----------------|--|
| 1 | 999 999 999 322 | 60x60 Clip-in Aparat - 60x60 Clip-in Apparatus |
| 2 | 999 999 999 320 | 60x60 Alçıpan Tavan Aparat - 60x60 Drywall Apparatus |
| 3 | 999 999 999 321 | 60x60 Sıvaüstü Aparat - 60x60 S/M Apparatus |

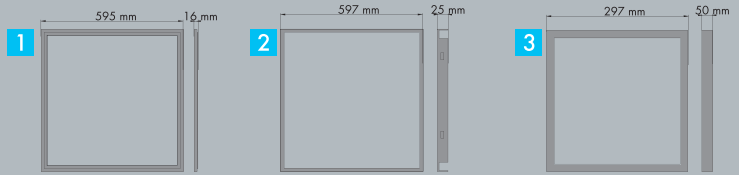

CONCORDELED

LED Etanj Armatür
LED Waterproof Luminaires

Ürün Kodu / Product Code

016 039 106020

Ölçü - Dimensions 60 cm

Güç - Power 20W

Lumen 2640 Lm

Işık Renk - Light Color 6500K

IP 66

Ürün Kodu / Product Code

016 039 112028

Ölçü - Dimensions 120 cm

Güç - Power 28 W

Lumen 3520 Lm

Işık Renk - Light Color 6500K

IP 66



LEDETANJ

LED Etanj Armatür
LED Waterproof Luminaires

Ürün Kodu / Product Code	016 038 666560	016 038 676560	016 038 686560	016 038 696560
Ölçü - Dimensions	60 cm	60 cm	120 cm	120 cm
Güç - Power	10 W	20 W	20 W	40 W
Lumen	950 Lm	1880 Lm	1880 Lm	3760 Lm
Işık Renk - Light Color	6000K	6000K	6000K	6000K

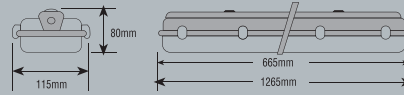

WALWASHER

LED Aydınlatma Armatür
LED Lighting Luminaires

Ürün Kodu / Product Code	016 040 100001	016 040 100002	016 040 100003	016 040 100004	016 040 100005	016 040 100006
Led Sayısı - Led Pcs	12	12	18	18	36	36
Ölçü - Dimensions	35 cm	35 cm	50 cm	50 cm	100 cm	100 cm
Güç - Power	12 W	12 W	18 W	18 W	32 W	32 W
Lumen	900 Lm	963 Lm	1550 Lm	1605 Lm	3000 Lm	3210 Lm
Işık Renk - Light Color	3000K	6500K	3000K	6500K	3000K	6500K



Downlight Backlight Led Armatürler

Downlight Led Lightings

Özellikler

Gövde : Alüminyum
Boya : Beyaz elektrostatik toz boya

Description

Body : Aluminium
Paint : Electrostatic white powder paint

Wat	Kod Code	Inch	Işık Rengi Light Color	Lumen	CRI	Ölçü (mm) Size (mm)	Kesim Ölçüsü (mm) Cutting Size (mm)	IP
8 w	016 038 302008	2,5	3000K	720	85+	90x25	80	20
	016 038 402008		4000K					
	016 038 602008		6000K					
12 w	016 038 302012	4	3000K	1116	85+	122x25	105	20
	016 038 402012		4000K					
	016 038 602012		6000K					
18 w	016 038 302018	6	3000K	1710	85+	175x25	155	20
	016 038 402018		4000K					
	016 038 602018		6000K					
23 w	016 038 302023	8	3000K	2230	85+	225x25	200	20
	016 038 402023		4000K					
	016 038 602023		6000K					

LED
OSRAM - SAMSUNG
DRIVER
OSRAM - TRIDONIC



Backlight Led Armatürler 30x30

Led Lightings 30x30

Özellikler

Gövde : DKP Saç
Boya : Beyaz elektrostatik toz boya

Description

Body : Steel
Paint : Electrostatic white powder paint

Kod Code	Wat	Işık Rengi Light Color	Lumen	CRI	Ölçü (mm) Size (mm)	Kesim Ölçüsü (mm) Cutting Size (mm)	IP	
Clip-In Tavan Clip-In Ceiling	016 038 314030	15	3000K	1515	85+	297x297x45	40	
	016 038 314040	15	4000K	1515	85+	297x297x45	40	
	016 038 314060	15	6000K	1515	85+	297x297x45	40	
	016 038 315430	15	3000K	1515	85+	297x297x45	54	
	016 038 315440	15	4000K	1515	85+	297x297x45	54	
	016 038 315460	15	6000K	1515	85+	297x297x45	54	
Taş Yünü Tavan Clip-In Ceiling	016 038 324030	15	3000K	1515	85+	297x297x45	40	
	016 038 324040	15	4000K	1515	85+	297x297x45	40	
	016 038 324060	15	6000K	1515	85+	297x297x45	40	
	016 038 325430	15	3000K	1515	85+	297x297x45	54	
	016 038 325440	15	4000K	1515	85+	297x297x45	54	
	016 038 325460	15	6000K	1515	85+	297x297x45	54	
Alçıpan Tavan Clip-In Ceiling	016 038 334030	15	3000K	1515	85+	297x297x45	275x275	40
	016 038 334040	15	4000K	1515	85+	297x297x45	275x275	40
	016 038 334060	15	6000K	1515	85+	297x297x45	275x275	40
	016 038 335430	15	3000K	1515	85+	297x297x45	275x275	54
	016 038 335440	15	4000K	1515	85+	297x297x45	275x275	54
	016 038 335460	15	6000K	1515	85+	297x297x45	275x275	54
Sıva Üstü Clip-In Ceiling	016 038 344030	15	3000K	1515	85+	310x310x60	40	
	016 038 344040	15	4000K	1515	85+	310x310x60	40	
	016 038 344060	15	6000K	1515	85+	310x310x60	40	
	016 038 345430	15	3000K	1515	85+	310x310x60	54	
	016 038 345440	15	4000K	1515	85+	310x310x60	54	
	016 038 345460	15	6000K	1515	85+	310x310x60	54	

LED
OSRAM - SAMSUNG
DRIVER
OSRAM - TRIDONIC



Backlight Led Armatürler 60x60

Led Lightings 60x60

Özellikler

Gövde : DKP Saç
Boya : Beyaz elektrostatik toz boya

Description

Body : Steel
Paint : Electrostatic white powder paint

Kod Code	Wat	Işık Rengi Light Color	Lumen	CRI	Ölçü (mm) Size (mm)	Kesim Ölçüsü (mm) Cutting Size (mm)	IP
Clip-In Tavan Clip-In Ceiling	016 038 614030	35	3000K	3390	85+	595x595x65	40
	016 038 614040	35	4000K	3390	85+	595x595x65	40
	016 038 614060	35	6000K	3390	85+	595x595x65	40
	016 038 615430	35	3000K	3390	85+	595x595x65	54
	016 038 615440	35	4000K	3390	85+	595x595x65	54
	016 038 615460	35	6000K	3390	85+	595x595x65	54
Taş Yünü Tavan Clip-In Ceiling	016 038 624030	35	3000K	3390	85+	595x595x65	40
	016 038 624040	35	4000K	3390	85+	595x595x65	40
	016 038 624060	35	6000K	3390	85+	595x595x65	40
	016 038 625430	35	3000K	3390	85+	595x595x65	54
	016 038 625440	35	4000K	3390	85+	595x595x65	54
	016 038 625460	35	6000K	3390	85+	595x595x65	54
Alçıpan Tavan Clip-In Ceiling	016 038 634030	35	3000K	3390	85+	595x595x65	40
	016 038 634040	35	4000K	3390	85+	595x595x65	40
	016 038 634060	35	6000K	3390	85+	595x595x65	40
	016 038 635430	35	3000K	3390	85+	595x595x65	54
	016 038 635440	35	4000K	3390	85+	595x595x65	54
	016 038 635460	35	6000K	3390	85+	595x595x65	54
Sıva Üstü Clip-In Ceiling	016 038 644030	35	3000K	3390	85+	610x610x75	40
	016 038 644040	35	4000K	3390	85+	610x610x75	40
	016 038 644060	35	6000K	3390	85+	610x610x75	40
	016 038 645430	35	3000K	3390	85+	610x610x75	54
	016 038 645440	35	4000K	3390	85+	610x610x75	54
	016 038 645460	35	6000K	3390	85+	610x610x75	54



Backlight Hygiene Armatürler 60x60

Led Hygiene Lightings 60x60

Özellikler

Gövde : DKP Saç
Boya : Beyaz elektrostatik toz boya
Cam : Temperli Cam

Description

Body : Steel
Paint : Electrostatic white powder paint
Glass : Tempered Glass

Kod Code	Wat	Işık Rengi Light Color	Lumen	CRI	Ölçü (mm) Size (mm)	Kesim Ölçüsü (mm) Cutting Size (mm)	IP
016 038 755470	42	3000K	4000	85+	595x595x82	575x575	65
016 038 755480	42	4000K	4000	85+	595x595x82	575x575	65
016 038 755490	42	6000K	4000	85+	595x595x82	575x575	65





Alüminyum Led Etanj Armatürler Aluminium Led Waterproof Lightings 60x60

Özellikler

Gövde : Alüminyum
Cam : PC

Description

Body : Aluminium
Glass : PC

Kod Code	Wat	Işık Rengi Light Color	Lumen	CRI	Ölçü (mm) Size (mm)	IP
60 cm	016 038 705430	10	3000K	950	85+ 600x85x115	54
	016 038 705440	10	4000K	950	85+ 600x85x115	54
	016 038 705460	10	6000K	950	85+ 600x85x115	54
	016 038 715430	20	3000K	1900	85+ 600x85x115	54
	016 038 715440	20	4000K	1900	85+ 600x85x115	54
	016 038 715460	20	6000K	1900	85+ 600x85x115	54
120 cm	016 038 725430	20	3000K	1900	85+ 1200x85x115	54
	016 038 725440	20	4000K	1900	85+ 1200x85x115	54
	016 038 725460	20	6000K	1900	85+ 1200x85x115	54
	016 038 735430	40	3000K	3800	85+ 1200x85x115	54
	016 038 735440	40	4000K	3800	85+ 1200x85x115	54
	016 038 735460	40	6000K	3800	85+ 1200x85x115	54
150 cm	016 038 745430	40	3000K	3800	85+ 1500x85x115	54
	016 038 745440	40	4000K	3800	85+ 1500x85x115	54
	016 038 745460	40	6000K	3800	85+ 1500x85x115	54
	016 038 755430	50	3000K	4700	85+ 1500x85x115	54
	016 038 755440	50	4000K	4700	85+ 1500x85x115	54
	016 038 755460	50	6000K	4700	85+ 1500x85x115	54



T8**Sıvaüstü Çift Parabolik Armatürler (Elektronik Balastlı)**
S/M Double Parabolic Lighting Luminaries (Electronic Ballast)

Ürün Kodu / Product Code

090 038 000218 TIL-218-SM S/Ü 2x18

090 038 000418 TIL-418-SM S/Ü 4x18

090 038 000236 TIL-236-SM S/Ü 2x36

Özellikler

Gövde : 0.5mm DKP- Galvanizli sac
 Boya : Beyaz elektrostatik toz boya
 Güç : 230 V 50Hz
 Reflektör : Yüksek kaliteli %99.99 saflıkta alüminyum parlak ve mat reflektor seçeneği.
 Balast : Elektronik (Philips, Tridonic), Dim edilebilir ballast seçeneği
 Opsiyon : Acil durum kiti

Description

Body : 0.5mm DKP - Galvanized steel
 Paint : Electrostatic white powder paint
 Power : 230 V 50 Hz
 Reflector : High quality %99.99 pure aluminium specular or matt option.
 Ballast : Electronic (Philips, Tridonic), Dimmable ballast option
 Optional : Emergency kit

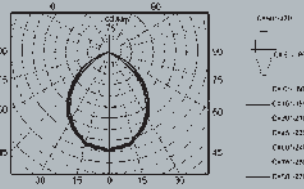
**T8****Sıvaaltı Çift Parabolik Armatürler (Elektronik Balastlı)**
R/M Double Parabolic Lighting Luminaries (Electronic Ballast)

Ürün Kodu / Product Code

090 038 100218 TIL-218-RM S/A 2x18

090 038 100418 TIL-418-RM S/A 4x18

090 038 100236 TIL-236-RM S/A 2x36

Özellikler

Gövde : 0.5mm DKP- Galvanizli sac
 Boya : Beyaz elektrostatik toz boya
 Güç : 230 V 50Hz
 Reflektör : Yüksek kaliteli %99.99 saflıkta alüminyum parlak ve mat reflektor seçeneği.
 Balast : Elektronik (Philips, Tridonic), Dim edilebilir ballast seçeneği
 Opsiyon : Acil durum kiti

Description

Body : 0.5mm DKP - Galvanized steel
 Paint : Electrostatic white powder paint
 Power : 230 V 50 Hz
 Reflector : High quality %99.99 pure aluminium specular or matt option.
 Ballast : Electronic (Philips, Tridonic), Dimmable ballast option
 Optional : Emergency kit

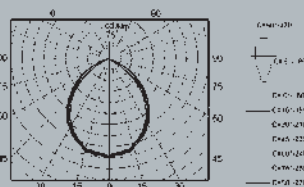

T8**Sıvaüstü Çift Parabolik Armatürler (Mekanik Balastlı)**
S/M Double Parabolic Lighting Luminaries (Mekanik Ballast)**Ürün Kodu / Product Code**

090 039 171218 218-SM S/Ü 2x18

090 039 151418 418-SM S/Ü 4x18

090 039 171236 236-SM S/Ü 2x36

Özellikler

Gövde : 0.5mm DKP- Galvanizli sac
 Boya : Beyaz elektrostatik toz boya
 Güç : 230 V 50Hz
 Reflektör : Yüksek kaliteli %99.99 saflıkta alüminyum parlak ve mat reflektör seçeneği.
 Balast : Elektronik (Philips, Tridonic), Dim edilebilir ballast seçeneği
 Opsiyon : Acil durum kiti

Description

Body : 0.5mm DKP - Galvanized steel
 Paint : Electrostatic white powder paint
 Power : 230 V 50 Hz
 Reflector : High quality %99.99 pure aluminium specular or matt option.
 Ballast : Electronic (Philips, Tridonic), Dimmable ballast option
 Optional : Emergency kit

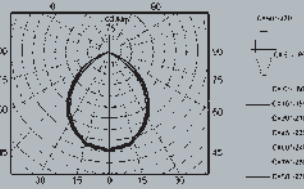
**T8****Sıvaaltı Çift Parabolik Armatürler (Mekanik Balastlı)**
R/M Double Parabolic Lighting Luminaries (Mekanik Ballast)**Ürün Kodu / Product Code**

090 039 161218 218-RM S/A 2x18

090 039 141418 418-RM S/A 4x18

090 039 161236 236-RM S/A 2x36

Özellikler

Gövde : 0.5mm DKP- Galvanizli sac
 Boya : Beyaz elektrostatik toz boya
 Güç : 230 V 50Hz
 Reflektör : Yüksek kaliteli %99.99 saflıkta alüminyum parlak ve mat reflektör seçeneği.
 Balast : Elektronik (Philips, Tridonic), Dim edilebilir ballast seçeneği
 Opsiyon : Acil durum kiti

Description

Body : 0.5mm DKP - Galvanized steel
 Paint : Electrostatic white powder paint
 Power : 230 V 50 Hz
 Reflector : High quality %99.99 pure aluminium specular or matt option.
 Ballast : Electronic (Philips, Tridonic), Dimmable ballast option
 Optional : Emergency kit

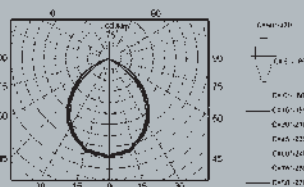



TL5 Yüksek Tavan Aydınlatma Armatürleri High Ceiling Lighting Luminaire

Ürün Kodu / Product Code

090 039 400228	2x28W TL5
090 039 400428	4x28W TL5
090 039 400254	2x54W TL5
090 039 400454	4x54W TL5
090 039 400235	2x35W TL5
090 039 400435	4x35W TL5
090 039 400280	2x80W TL5
090 039 400480	4x80W TL5

Özellikler

Gövde : 0.5 mm DKP sac,
Boya : Gri elektrostatik toz boya
Güç : 230 V 50 Hz
Balast : Elektronik (EVG), Dim edilebilir balast seçeneği (EVG DIMM)
Opsiyon : Acil durum kit

Description

Body : 0.5 mm DKP sheet
Paint : Electrostatic white powder paint
Power : 230V 50 Hz
Ballast : Electronic (EVG), Dimmable ballast option (EVG DIMM)
Optional : Emergency kit

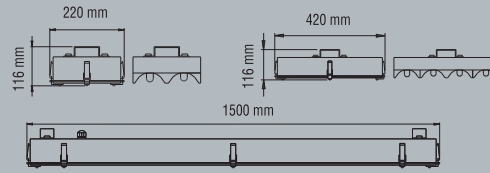

TMS Bant Tipi T8 Mekanik Armatürler Batten Type T8 Mekanik Luminaries

Ürün Kodu / Product Code

078 038 900118	1x18W
078 038 900136	1x36W
078 038 900218	2x18W
078 038 900236	2x36W

Özellikler

Gövde : 0.5 mm DKP sac,
Boya : Beyaz elektrostatik toz boya
Güç : 230 V 50 Hz

Description

Body : 0.5 mm DKP sheet
Paint : Electrostatic white powder paint
Power : 230V 50 Hz

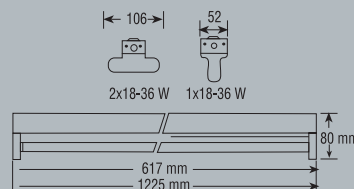

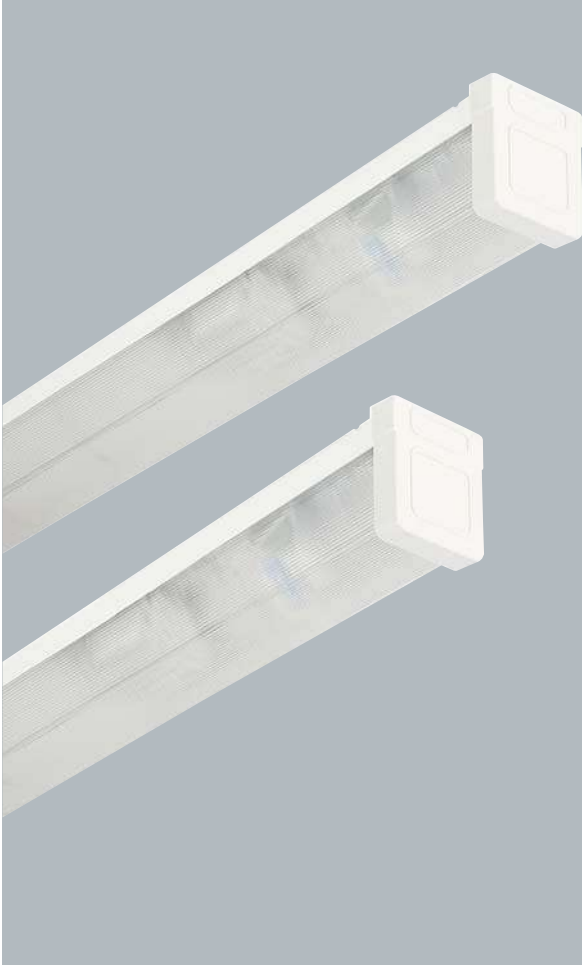
**TSC****Okul Tipi Armatürler (Elektronik Tridonic Balastlı)**
School Type (Electronic Tridonic Ballast)

Ürün Kodu / Product Code

078 040 050118 1x18W

078 040 050136 1x36W

078 040 050218 2x18W

078 040 050236 2x36W

Özellikler

Gövde : 0.5 mm DKP sac,
Boya : Beyaz elektrostatik
toz boya
Güç : 230 V 50 Hz
Kapak : PMMA

Description

Body : 0.5 mm DKP sheet
Paint : Electrostatic white
powder paint
Power : 230V 50 Hz
Diffuzor : PMMA

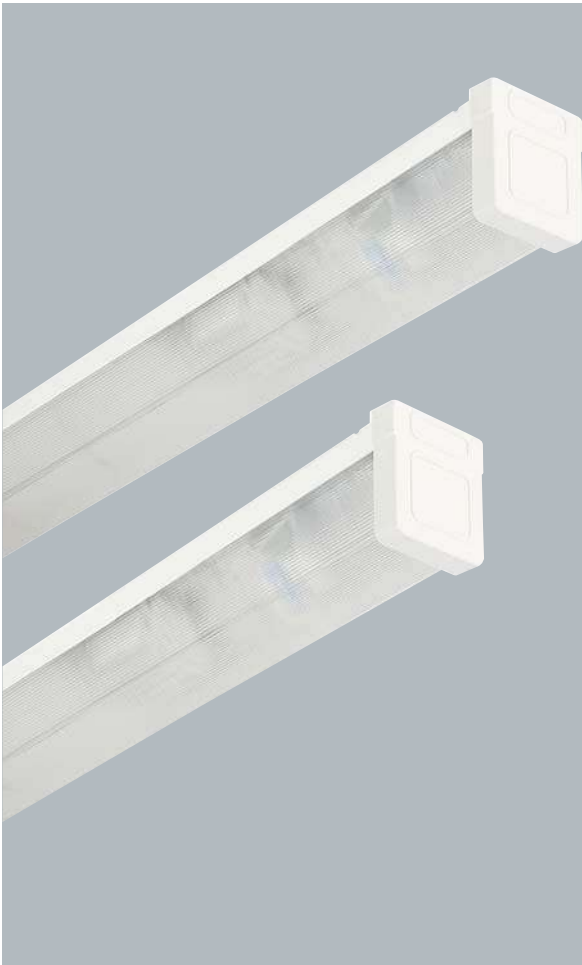
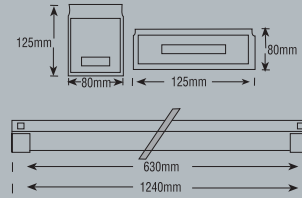
**TSC****Okul Tipi Armatürler (Mekanik Balastlı)**
School Type (Mekanik Ballast)

Ürün Kodu / Product Code

078 038 050118 1x18W

078 038 050136 1x36W

078 038 050218 2x18W

078 038 050236 2x36W

Özellikler

Gövde : 0.5 mm DKP sac,
Boya : Beyaz elektrostatik
toz boya
Güç : 230 V 50 Hz
Kapak : PMMA

Description

Body : 0.5 mm DKP sheet
Paint : Electrostatic white
powder paint
Power : 230V 50 Hz
Diffuzor : PMMA

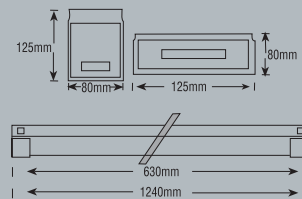

**U TİPİ**

Etanj Aydınlatma Armatürleri PC Cam
(Elektronik Tridonic Balastlı)

Waterproof Luminaires PC Glass
(Electronic Tridonic Ballast)

Ürün Kodu / Product Code

- 090 038 220118 1x18 PC Cam PC Gövde - 1x18 PC Glass PC Body
 090 038 220218 2x18 PC Cam PC Gövde - 2x18 PC Glass PC Body
 090 038 220136 1x36 PC Cam PC Gövde - 1x36 PC Glass PC Body
 090 038 220236 2x36 PC Cam PC Gövde - 2x36 PC Glass PC Body

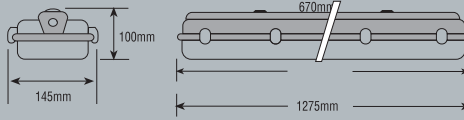
**U TİPİ**

Etanj Aydınlatma Armatürleri PC Cam
(Mekanik Balastlı)

Waterproof Luminaires PC Glass
(Mekanik Ballast)

Ürün Kodu / Product Code

- 090 038 210118 1x18 PC Cam PC Gövde - 1x18 PC Glass PC Body
 090 038 210218 2x18 PC Cam PC Gövde - 2x18 PC Glass PC Body
 090 038 210136 1x36 PC Cam PC Gövde - 1x36 PC Glass PC Body
 090 038 210236 2x36 PC Cam PC Gövde - 2x36 PC Glass PC Body

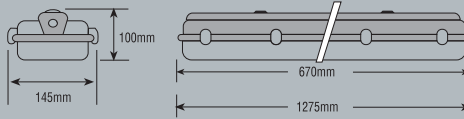
**U TİPİ**

Etanj Aydınlatma Armatürleri Akrilik Cam
(Mekanik Balastlı)

Waterproof Luminaires Acrylic Glass
(Mekanik Ballast)

Ürün Kodu / Product Code

- 066 038 910118 1x18 Akrilik Cam PC Gövde - 1x18 Acrylic Glass PC Body
 066 038 910218 2x18 Akrilik Cam PC Gövde - 2x18 Acrylic Glass PC Body
 066 038 910136 1x36 Akrilik Cam PC Gövde - 1x36 Acrylic Glass PC Body
 066 038 910236 2x36 Akrilik Cam PC Gövde - 2x36 Acrylic Glass PC Body

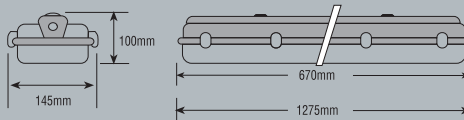

**MINI**Tavan Glob Armatür
Ceiling Globe Lighting FixtureÜrün Kodu / Product Code
016 038 250031

E27 MAX. 1x75W - 230 V ~ 50 Hz IP20

Ambalaj Şekli / Package Type Kutu / Pack

Adet / m / Quantity / m 48

Ağırlık / Weight 15.77 kg

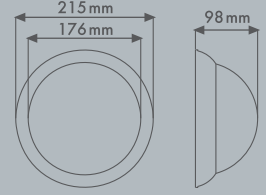
m³ / Volume 0.210**YASEMİN**Ufo Küre Tavan Armatürü
Ufo Globe Ceiling Lighting FixtureÜrün Kodu / Product Code
001 038 050101 00 00





E27 MAX. 1x60W - 230 V ~ 50 Hz

Ambalaj Şekli / Package Type Kutu / Pack

Adet / m / Quantity / m 12

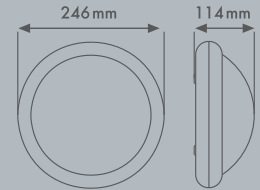
Ağırlık / Weight 4.08 kg

m³ / Volume 0.082**YASEMİN**Ufo Düz Tavan Armatürü
Ufo Flat Ceiling Lighting FixtureÜrün Kodu / Product Code
001 038 070101 00 00







E27 MAX. 1x60W - 230 V ~ 50 Hz

Ambalaj Şekli / Package Type Kutu / Pack

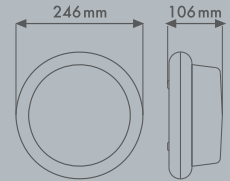
Adet / m / Quantity / m 12

Ağırlık / Weight 4.53 kg

m³ / Volume 0.082**YASEMİN**Küre Tavan Armatürü
Globe Ceiling Lighting FixtureÜrün Kodu / Product Code
001 038 060101 00 00



E27 MAX. 1x60W - 230 V ~ 50 Hz

Ambalaj Şekli / Package Type Kutu / Pack

Adet / m / Quantity / m 12

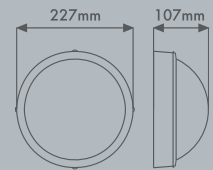
Ağırlık / Weight 5.59 kg

m³ / Volume 0.082

**YASEMİN**Düz Tavan Armatürü
Flat Ceiling Lighting FixtureÜrün Kodu / Product Code
001 038 030101 00 00

CLASS I IP20

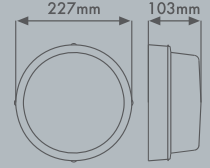

E27 MAX. 1x60W - 230 V ~ 50 Hz

Ambalaj Şekli / Package Type	Kutu / Pack	Ağırlık / Weight	3.52 kg
Adet / m / Quantity / m	12	m ³ / Volume	0.082

**YASEMİN**Ufo Tavan Armatürü
Ufo Ceiling Lighting FixtureÜrün Kodu / Product Code
001 038 040101 00 00

CLASS II IP20

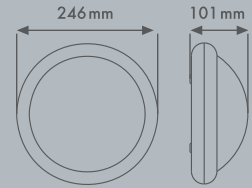

E27 MAX. 1x60W - 230 V ~ 50 Hz

Ambalaj Şekli / Package Type	Kutu / Pack	Ağırlık / Weight	4.11 kg
Adet / m / Quantity / m	12	m ³ / Volume	0.082

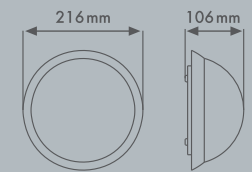
**ORKİDE**Tavan Armatürü
Ceiling Lighting FixtureÜrün Kodu / Product Code
001 038 120101 00 00

E27 MAX. 1x60W - 230 V ~ 50 Hz

Ambalaj Şekli / Package Type	Kutu / Pack	Ağırlık / Weight	5.66 kg
Adet / m / Quantity / m	24	m ³ / Volume	0.097

**YONCA**Tavan Armatürü
Lighting FixtureÜrün Kodu / Product Code
001 038 160101 00 00

CLASS I IP20

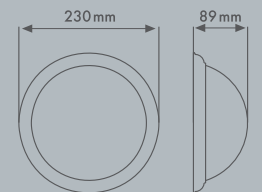

E27 MAX. 1x60W - 230 V ~ 50 Hz

Ambalaj Şekli / Package Type	Kutu / Pack	Ağırlık / Weight	4.01 kg
Adet / m / Quantity / m	16	m ³ / Volume	0.064

**OVAL**

Düz Armatür
Antigron Lighting Fixture

Ürün Kodu / Product Code
016 038 250028

E27 MAX. 1x60W - 230 V ~ 50 Hz IP20

Ambalaj Şekli / Package Type Kutu / Pack

Adet / m / Quantity / m 48

Ağırlık / Weight 15.77 kg

m³ / Volume 0.138

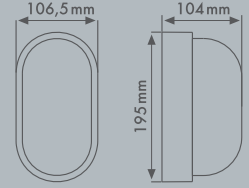
**OVAL**

Kafesli Armatür
Oval Antigron Lighting Fixture

Ürün Kodu / Product Code
016 038 250029

E27 MAX. 1x60W - 230 V ~ 50 Hz IP20

Ambalaj Şekli / Package Type Kutu / Pack

Adet / m / Quantity / m 48

Ağırlık / Weight 16.47 kg

m³ / Volume 0.138

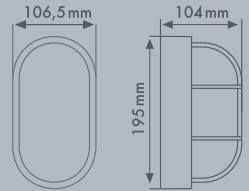
**OVAL**
Nemliyer Waterproff

Düz Armatür
Antigron Lighting Fixture

Ürün Kodu / Product Code
016 038 250039

E27 MAX. 1x60W - 230 V ~ 50 Hz IP 44

Ambalaj Şekli / Package Type Kutu / Pack

Adet / m / Quantity / m 48

Ağırlık / Weight 15.77 kg

m³ / Volume 0.138

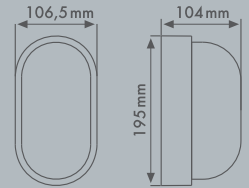
**OVALLED**

Kafesli Led Armatür
Oval Antigron Led Lighting Fixture

Ürün Kodu / Product Code
016 038 270001

IP 20

Ambalaj Şekli / Package Type Kutu / Pack

Adet / m / Quantity / m 20

Ağırlık / Weight 6.86 kg

m³ / Volume 0.058

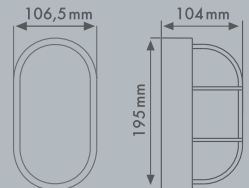



BEGONYA

Nemliyer Waterproff

Tavan ve Duvar Armatürü (Dikey)
Ceiling & Wall Lighting Fixture (Vertical)

Ürün Kodu / Product Code
001 038 130101 00 00



CLASS II IP54



E27 MAX. 1x60W - 230 V ~ 50 Hz

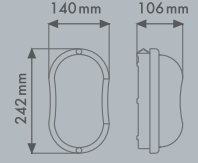

Ambalaj Şekli / Package Type	Kutu / Pack	Ağırlık / Weight	4.68 kg
Adet / m / Quantity / m	12	m ³ / Volume	0.043



BEGONYA

Nemliyer Waterproff

Tavan ve Duvar Armatürü (Yatay)
Ceiling & Wall Lighting Fixture (Horizontal)

Ürün Kodu / Product Code
001 038 140101 00 00



CLASS II IP54



E27 MAX. 1x60W - 230 V ~ 50 Hz

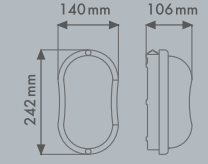

Ambalaj Şekli / Package Type	Kutu / Pack	Ağırlık / Weight	4.69 kg
Adet / m / Quantity / m	12	m ³ / Volume	0.043



BEGONYA

Nemliyer Waterproff

Tavan ve Duvar Armatürü (Klasik)
Ceiling & Wall Lighting Fixture (Classic)

Ürün Kodu / Product Code
001 038 150101 00 00



CLASS II IP54



E27 MAX. 1x60W - 230 V ~ 50 Hz

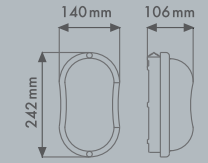

Ambalaj Şekli / Package Type	Kutu / Pack	Ağırlık / Weight	4.67 kg
Adet / m / Quantity / m	12	m ³ / Volume	0.043

**FULYA**Aplik
Wall Lamp

Ürün Kodu / Product Code
001 038 020201 00 00



CLASS I IP20

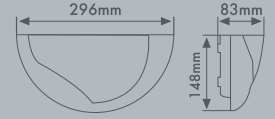

E27 MAX. 1x60W - 230 V ~ 50 Hz

Ambalaj Şekli / Package Type	Kutu / Pack	Ağırlık / Weight	3.06 kg
Adet / m / Quantity / m	10	m ³ / Volume	0.048

**MANOLYA**Aplik
Wall Lamp

Ürün Kodu / Product Code
001 038 010201 00 00



CLASS I IP20

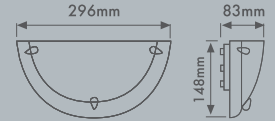

E27 MAX. 1x60W - 230 V ~ 50 Hz

Ambalaj Şekli / Package Type	Kutu / Pack	Ağırlık / Weight	2.61 kg
Adet / m / Quantity / m	10	m ³ / Volume	0.048

**YASEMİN**Aplik
Wall Lamp

Ürün Kodu / Product Code
001 038 090101 00 00



CLASS I IP20

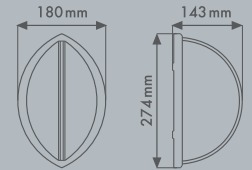

E27 MAX. 1x60W - 230 V ~ 50 Hz

Ambalaj Şekli / Package Type	Kutu / Pack	Ağırlık / Weight	3.63 kg
Adet / m / Quantity / m	8	m ³ / Volume	0.056

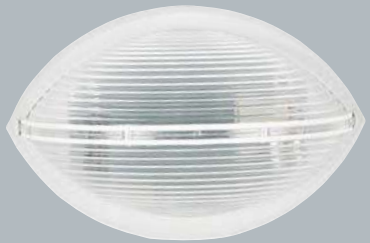
**YASEMİN**Oval Tavan Armatürü
Oval Lighting Fixture

Ürün Kodu / Product Code
001 038 080101 00 00



CLASS I IP20

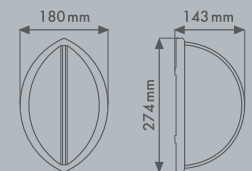

E27 MAX. 1x60W - 230 V ~ 50 Hz

Ambalaj Şekli / Package Type	Kutu / Pack	Ağırlık / Weight	3.39 kg
Adet / m / Quantity / m	8	m ³ / Volume	0.056

**FULYA**Tavan Armatürü
Ceiling Lighting FixtureÜrün Kodu / Product Code
001 038 020101 00 00

CLASS II IP20



E27 MAX. 1x75W - 230 V ~ 50 Hz

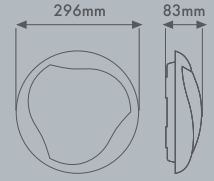

Ambalaj Şekli / Package Type	Kutu / Pack	Ağırlık / Weight	2.71 kg
Adet / m / Quantity / m	5	m ³ / Volume	0.048

**AKASYA**Tavan Armatürü
Ceiling Lighting FixtureÜrün Kodu / Product Code
001 038 180101 00 00

CLASS II IP20



E27 MAX. 1x60W - 230 V ~ 50 Hz

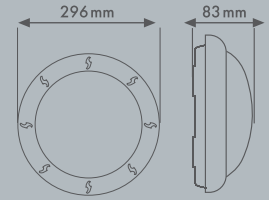

Ambalaj Şekli / Package Type	Kutu / Pack	Ağırlık / Weight	2.70 kg
Adet / m / Quantity / m	8	m ³ / Volume	0.044

**KAMELYA**Tavan Armatürü
Ceiling Lighting FixtureÜrün Kodu / Product Code
001 038 170101 00 00

CLASS II IP54



E27 MAX. 1x60W - 230 V ~ 50 Hz

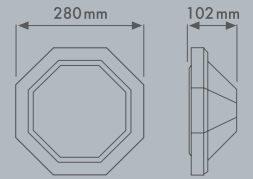

Ambalaj Şekli / Package Type	Kutu / Pack	Ağırlık / Weight	2.60 kg
Adet / m / Quantity / m	5	m ³ / Volume	0.042

**MERVE**Tavan Armatürü
Ceiling Lighting FixtureÜrün Kodu / Product Code
001 038 110101 00 00

CLASS II IP20



E27 MAX. 1x60W - 230 V ~ 50 Hz

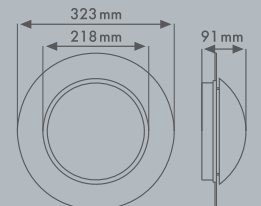

Ambalaj Şekli / Package Type	Kutu / Pack	Ağırlık / Weight	2.30 kg
Adet / m / Quantity / m	5	m ³ / Volume	0.047



PİRAMİT

Aplik
Wall Lamp

Ürün Kodu / Product Code
001 038 190201 00 00



CLASS I IP20

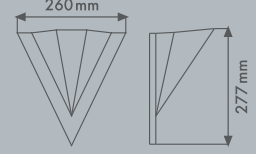

E27 MAX. 1x60W - 230 V ~ 50 Hz

Ambalaj Şekli / Package Type	Kutu / Pack	Ağırlık / Weight	4.35 kg
Adet / m / Quantity / m	8	m ³ / Volume	0.082



KRALIÇE

Duvar Aplik
Queen Wall Lamp

Ürün Kodu / Product Code
016 038 250013

E27 MAX. 1x60W - 230 V ~ 50 Hz IP20

Ambalaj Şekli / Package Type Kutu / Pack

Adet / m / Quantity / m 48

Ağırlık / Weight 17.52 kg

m³ / Volume 0.139

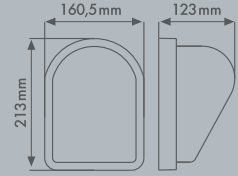

MANOLYA

Tavan Armatürü
Ceiling Lighting Fixture

Ürün Kodu / Product Code
001 038 010101 00 00



CLASS II IP20

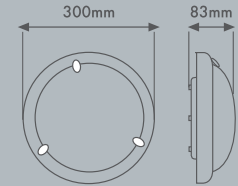

E27 MAX. 1x75W - 230 V ~ 50 Hz

Ambalaj Şekli / Package Type	Kutu / Pack	Ağırlık / Weight	2.69 kg
Adet / m / Quantity / m	5	m ³ / Volume	0.048

**SADE**

Hazır Askı Tij Takımı
Lamp Holder and Hanging Set

Ürün Kodu / Product Code
001 038 250018 00 00

E27

Ambalaj Şekli / Package Type Kutu / Pack

Adet / m / Quantity / m 500

Ağırlık / Weight 37.62 kg

m³ / Volume 0.131

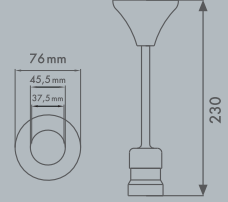
**PAPATYA**

Askı Tij Takımı
Lamp Holder and Hanging Set

Ürün Kodu / Product Code
001 038 250016 00 00

E27

Ambalaj Şekli / Package Type Kutu / Pack

Adet / m / Quantity / m 250

Ağırlık / Weight 24.25 kg

m³ / Volume 0.131

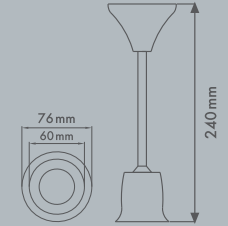
**PAPATYA**

Büyük Askı Tij Takımı
Lamp Holder and Hanging Set Big

Ürün Kodu / Product Code
001 038 250017 00 00

E27

Ambalaj Şekli / Package Type Kutu / Pack

Adet / m / Quantity / m 80

Ağırlık / Weight 11.20 kg

m³ / Volume 0.131

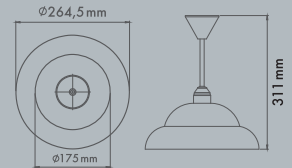



AQUA

Nemliyer Waterproof

Kafesli Aplik Armatür Beyaz
Wall Fixture Antigron White

Ürün Kodu / Product Code
016 038 411100

CLASS II

IP 54

MAX. 26 W

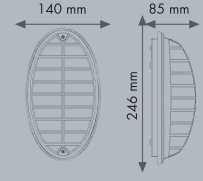

Ambalaj Şekli / Package Type	Kutu / Pack	Ağırlık / Weight	6.27 kg.
Adet / m / Quantity / m	20	m ³ / Volume	0.066



AQUA

Nemliyer Waterproof

Kafesli Aplik Armatür Siyah
Wall Fixture Antigron Black

Ürün Kodu / Product Code
016 038 411111

CLASS II

IP 54

MAX. 26 W

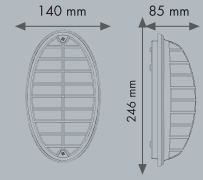

Ambalaj Şekli / Package Type	Kutu / Pack	Ağırlık / Weight	6.27 kg.
Adet / m / Quantity / m	20	m ³ / Volume	0.066



OPAK

Kafesli Armatür Beyaz
Fixture Antigron White

Ürün Kodu / Product Code
016 038 411300

CLASS II

IP 54

MAX. 26 W

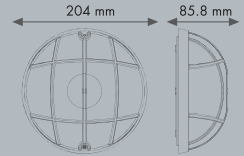

Ambalaj Şekli / Package Type	Kutu / Pack	Ağırlık / Weight	6.48 kg.
Adet / m / Quantity / m	24	m ³ / Volume	0.091



OPAK

Kafesli Armatür Siyah
Fixture Antigron Black

Ürün Kodu / Product Code
016 038 411311

CLASS II

IP 54

MAX. 26 W

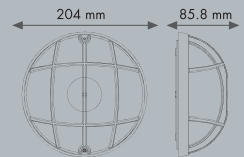

Ambalaj Şekli / Package Type	Kutu / Pack	Ağırlık / Weight	6.48 kg.
Adet / m / Quantity / m	24	m ³ / Volume	0.091

**ELİPS**Opal Armatür Beyaz
Opal Lighting Fixture WhiteÜrün Kodu / Product Code
016 038 410600

CLASS II

IP 65

MAX. 26 W

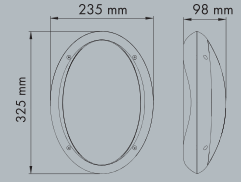

Ambalaj Şekli / Package Type	Kutu / Pack	Ağırlık / Weight	9.54 kg.
Adet / m / Quantity / m	10	m ³ / Volume	0.082

**ELİPS**Opal Armatür Siyah
Opal Lighting Fixture BlackÜrün Kodu / Product Code
016 038 410611

CLASS II

IP 65

MAX. 26 W

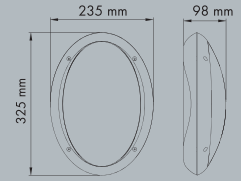

Ambalaj Şekli / Package Type	Kutu / Pack	Ağırlık / Weight	9.54 kg.
Adet / m / Quantity / m	10	m ³ / Volume	0.082

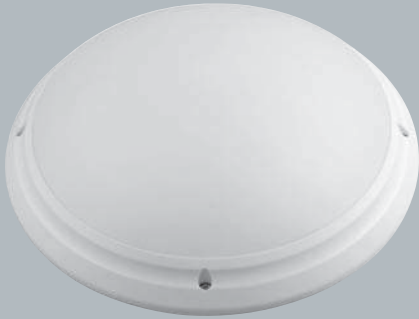
**OPAL**Armatür Beyaz
Lighting Fixture WhiteÜrün Kodu / Product Code
016 038 410500

CLASS II

IP 65

MAX. 26 W

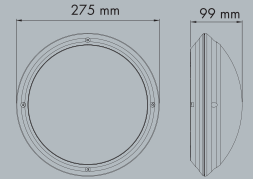

Ambalaj Şekli / Package Type	Kutu / Pack	Ağırlık / Weight	7.57 kg.
Adet / m / Quantity / m	10	m ³ / Volume	0.081

**OPAL**Armatür Siyah
Lighting Fixture BlackÜrün Kodu / Product Code
016 038 410511

CLASS II

IP 65

MAX. 26 W

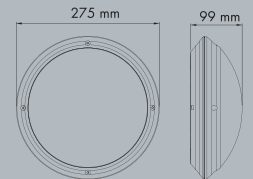

Ambalaj Şekli / Package Type	Kutu / Pack	Ağırlık / Weight	7.57 kg.
Adet / m / Quantity / m	10	m ³ / Volume	0.081

**DOLUNAY**Opak Armatür Beyaz
Opak Lighting Fixture WhiteÜrün Kodu / Product Code
016 038 700100

CLASS II

IP 54

MAX. 26 W

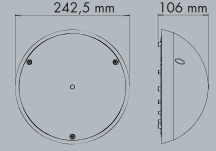

Ambalaj Şekli / Package Type	Kutu / Pack	Ağırlık / Weight	7.57 kg.
Adet / m / Quantity / m	10	m ³ / Volume	0.081

**DOLUNAY**Opak Armatür Siyah
Opak Lighting Fixture BlackÜrün Kodu / Product Code
016 038 700100

CLASS II

IP 54

MAX. 26 W

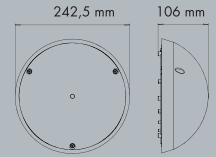

Ambalaj Şekli / Package Type	Kutu / Pack	Ağırlık / Weight	7.57 kg.
Adet / m / Quantity / m	10	m ³ / Volume	0.081

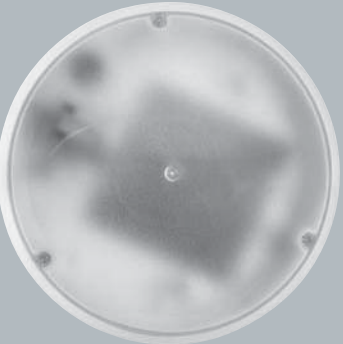
**DOLUNAY**Şeffaf Armatür Beyaz
Transparant Lighting Fixture WhiteÜrün Kodu / Product Code
016 038 700200

CLASS II

IP 54

MAX. 26 W

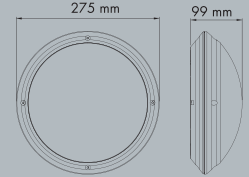

Ambalaj Şekli / Package Type	Kutu / Pack	Ağırlık / Weight	7.57 kg.
Adet / m / Quantity / m	10	m ³ / Volume	0.081

**DOLUNAY**Şeffaf Armatür Siyah
Transparant Lighting Fixture BlackÜrün Kodu / Product Code
016 038 700211

CLASS II

IP 54

MAX. 26 W

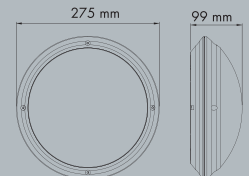

Ambalaj Şekli / Package Type	Kutu / Pack	Ağırlık / Weight	7.57 kg.
Adet / m / Quantity / m	10	m ³ / Volume	0.081

**DOLUNAY**Opak Aplik Beyaz
Opak Wall Lamp WhiteÜrün Kodu / Product Code
016 038 700300

MAX. 26 W

IP 54

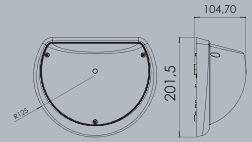

Ambalaj Şekli / Package Type	Kutu / Pack	Ağırlık / Weight	15.14kg.
Adet / m / Quantity / m	20	m ³ / Volume	0.162

**DOLUNAY**Opak Aplik Siyah
Opak Wall Lamp BlackÜrün Kodu / Product Code
016 038 700311

MAX. 26 W

IP 54

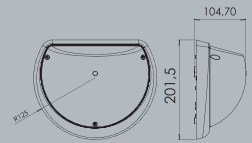

Ambalaj Şekli / Package Type	Kutu / Pack	Ağırlık / Weight	15.14kg.
Adet / m / Quantity / m	20	m ³ / Volume	0.162

**DOLUNAY**Şeffaf Armatür Beyaz
Transparant Lighting Fixture WhiteÜrün Kodu / Product Code
016 038 700400

MAX. 26 W

IP 54

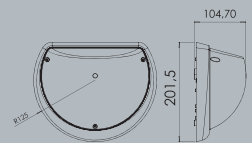

Ambalaj Şekli / Package Type	Kutu / Pack	Ağırlık / Weight	15.14kg.
Adet / m / Quantity / m	20	m ³ / Volume	0.162

**DOLUNAY**Şeffaf Armatür Siyah
Transparant Lighting Fixture BlackÜrün Kodu / Product Code
016 038 700411

MAX. 26 W

IP 54

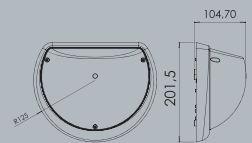

Ambalaj Şekli / Package Type	Kutu / Pack	Ağırlık / Weight	15.14kg.
Adet / m / Quantity / m	20	m ³ / Volume	0.162

**OPAK**Armatür Beyaz
Lighting Fixture WhiteÜrün Kodu / Product Code
016 038 410800

MAX. 26 W

IP 54

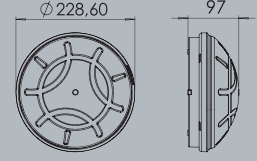

Ambalaj Şekli / Package Type	Kutu / Pack	Ağırlık / Weight	4.86 kg.
Adet / m / Quantity / m	16	m ³ / Volume	0.069

**OPAK**Armatür Siyah
Lighting Fixture BlackÜrün Kodu / Product Code
016 038 410811

MAX. 26 W

IP 54

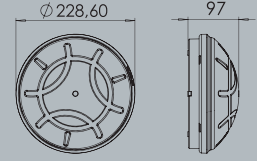

Ambalaj Şekli / Package Type	Kutu / Pack	Ağırlık / Weight	4.86 kg.
Adet / m / Quantity / m	16	m ³ / Volume	0.069

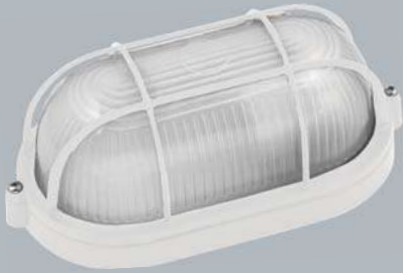
**ALÜMİNYUM**
Nemliyer WaterproffKafesli Cam Armatür Beyaz
Glass Fixture Antigron WhiteÜrün Kodu / Product Code
016 038 700500

MAX. 26 W

IP 54

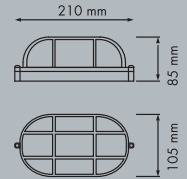

Ambalaj Şekli / Package Type	Kutu / Pack	Ağırlık / Weight	3 kg.
Adet / m / Quantity / m	20	m ³ / Volume	0.080

**ALÜMİNYUM**
Nemliyer WaterproffKafesli Cam Armatürü Siyah
Glass Fixture Antigron BlackÜrün Kodu / Product Code
016 038 700511

MAX. 26 W

IP 54

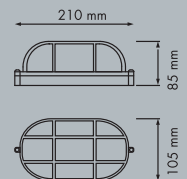

Ambalaj Şekli / Package Type	Kutu / Pack	Ağırlık / Weight	3 kg.
Adet / m / Quantity / m	20	m ³ / Volume	0.080

**RADARLED**

Radar Sensörlü Tavan Armatür
Radar Sensor Globe Lighting Fixture

Ürün Kodu / Product Code
016 038 250081

Lumen 900 Renk 6500K
Lumen 900 Color 6500K

IP 20

Ambalaj Şekli / Package Type	Kutu / Pack	Ağırlık / Weight	1.2 kg.
Adet / m / Quantity / m	20	m ³ / Volume	0.146

**RADARLED**

Radar Sensörlü Tavan Armatür
Radar Sensor Globe Lighting Fixture

Ürün Kodu / Product Code
016 038 250082

Lumen 900 Renk 6500K
Lumen 900 Color 6500K

IP 20

Ambalaj Şekli / Package Type	Kutu / Pack	Ağırlık / Weight	1.2 kg.
Adet / m / Quantity / m	20	m ³ / Volume	0.146

**RADARLED**

Radar Sensörlü Tavan Armatür
Radar Sensor Globe Lighting Fixture

Ürün Kodu / Product Code
016 038 250083

Lumen 900 Renk 6500K
Lumen 900 Color 6500K

IP 20

Ambalaj Şekli / Package Type	Kutu / Pack	Ağırlık / Weight	1.2 kg.
Adet / m / Quantity / m	20	m ³ / Volume	0.146

**RADARLED**

Radar Sensörlü Tavan Armatür
Radar Sensor Globe Lighting Fixture

Ürün Kodu / Product Code
016 038 250084

Lumen 900 Renk 6500K
Lumen 900 Color 6500K

IP 20

Ambalaj Şekli / Package Type	Kutu / Pack	Ağırlık / Weight	1.2 kg.
Adet / m / Quantity / m	20	m ³ / Volume	0.146

**LED**Tavan Armatür
Lighting FixtureÜrün Kodu / Product Code
016 038 250071Lumen 900 Renk 6500K
Lumen 900 Color 6500K IP 20

Ambalaj Şekli / Package Type	Kutu / Pack	Ağırlık / Weight	1.2 kg.
Adet / m / Quantity / m	20	m ³ / Volume	0.146

**LED**Tavan Armatür
Lighting FixtureÜrün Kodu / Product Code
016 038 250072Lumen 900 Renk 6500K
Lumen 900 Color 6500K IP 20

Ambalaj Şekli / Package Type	Kutu / Pack	Ağırlık / Weight	1.2 kg.
Adet / m / Quantity / m	20	m ³ / Volume	0.146

**LED**Tavan Armatür
Lighting FixtureÜrün Kodu / Product Code
016 038 250073Lumen 900 Renk 6500K
Lumen 900 Color 6500K IP 20

Ambalaj Şekli / Package Type	Kutu / Pack	Ağırlık / Weight	1.2 kg.
Adet / m / Quantity / m	20	m ³ / Volume	0.146

**LED**Tavan Armatür
Lighting FixtureÜrün Kodu / Product Code
016 038 250074Lumen 900 Renk 6500K
Lumen 900 Color 6500K IP 20

Ambalaj Şekli / Package Type	Kutu / Pack	Ağırlık / Weight	1.2 kg.
Adet / m / Quantity / m	20	m ³ / Volume	0.146

**360°**Hareket Sensörlü Glob Armatür
Sensor Globe Lighting Fixture

Ürün Kodu / Product Code
001 038 250022 00 00

E27 MAX. 2x25W - 230 V ~ 50 Hz IP20

Ambalaj Şekli / Package Type Kutu / Pack

Adet / m / Quantity / m 10

Ağırlık / Weight 14.46

m³ / Volume 0.124

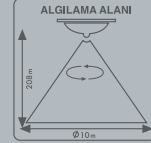
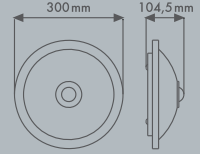
**80 LED**Ledli Sensörlü Tavan Armatürü
Led Sensor Ceiling Fixture

Ürün Kodu / Product Code
016 038 250044

80 Adet / 8 lm / 20 mA 120° LED
230 V ~ 50 Hz IP 20

Ambalaj Şekli / Package Type Kutu / Pack

Adet / m / Quantity / m 10

Ağırlık / Weight 13.76

m³ / Volume 0.124

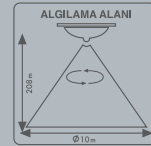
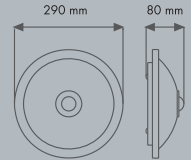
**80 KROMLED**Ledli Sensörlü Tavan Armatürü
Led Chrome Sensor Ceiling Fixture

Ürün Kodu / Product Code
016 038 600080

80 Adet / 8 lm / 20 mA 120° LED
230 V ~ 50 Hz IP 20

Ambalaj Şekli / Package Type Kutu / Pack

Adet / m / Quantity / m 10

Ağırlık / Weight 13.76

m³ / Volume 0.124

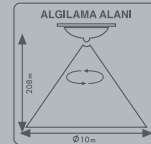
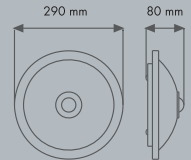



LEDSENSÖR

Led Sensörlü Glob Armatür
Sensor Led Lighting Fixture

Ürün Kodu / Product Code
016 038 250061

E27 MAX. 2x25W - 230 V ~ 50 Hz IP20

Ambalaj Şekli / Package Type Kutu / Pack

Adet / m / Quantity / m 10

Ağırlık / Weight 14.46

m³ / Volume 0.124

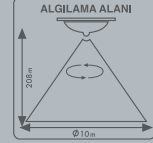
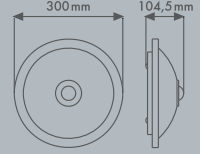

LEDSENSÖR

Led Sensörlü Glob Armatür - Kitli
Sensor Led Lighting Fixture - Kit

Ürün Kodu / Product Code
016 038 250060

E27 MAX. 2x25W - 230 V ~ 50 Hz IP20

Ambalaj Şekli / Package Type Kutu / Pack

Adet / m / Quantity / m 10

Ağırlık / Weight 14.46

m³ / Volume 0.124

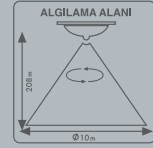
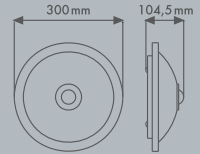

LEDSENSÖR

Duvar Aplik
Queen Wall Lamp

Ürün Kodu / Product Code
078 039 500110

E27 MAX. 2x25W - 230 V ~ 50 Hz IP20

Ambalaj Şekli / Package Type Kutu / Pack

Adet / m / Quantity / m 20

Ağırlık / Weight 10.40 kg

m³ / Volume 0.092



SENSÖR

E27 Duyulu Duvar Aplik
E27 Lamp Holder Wall Lamp

Ürün Kodu / Product Code
078 039 500100

E27 MAX. 2x25W - 230 V ~ 50 Hz IP20

Ambalaj Şekli / Package Type Kutu / Pack

Adet / m / Quantity / m 20

Ağırlık / Weight 10.40 kg

m³ / Volume 0.092

**DEKORATİF**Cam Armatür Beyaz
Glass Fixture WhiteÜrün Kodu / Product Code
079 039 140003

MAX. 2x60 W

IP 20

Ambalaj Şekli / Package Type	Kutu / Pack
Adet / m / Quantity / m	12
Ağırlık / Weight	14.46
m ³ / Volume	0.124

**DEKORATİF**Cam Armatür Krom Beyaz
Glass Fixture Chrome WhiteÜrün Kodu / Product Code
079 039 140002

MAX. 2x60 W

IP 20

Ambalaj Şekli / Package Type	Kutu / Pack
Adet / m / Quantity / m	12
Ağırlık / Weight	14.46
m ³ / Volume	0.124

**GÜNEŞ**Cam Armatür
Glass FixtureÜrün Kodu / Product Code
079 039 140005

MAX. 2x60 W

Ambalaj Şekli / Package Type	Kutu / Pack
Adet / m / Quantity / m	12
Ağırlık / Weight	14.46
m ³ / Volume	0.124

**GÜNEŞ**Yarım Ay Cam Aplik
Half Moon Glass Wall LampÜrün Kodu / Product Code
079 039 140001

MAX. 2x60 W

Ambalaj Şekli / Package Type	Kutu / Pack
Adet / m / Quantity / m	20
Ağırlık / Weight	14.46
m ³ / Volume	0.124

**CAM ARMATÜR**Cam Armatür Çift Duyulu
Glass Fixture Lamp HolderÜrün Kodu / Product Code
078 039 130002

MAX. 2x60 W

IP 20

Ambalaj Şekli / Package Type Kutu / Pack

Adet / m / Quantity / m 12

Ağırlık / Weight 14.46

m³ / Volume 0.124**CAM ARMATÜR**Cam Armatür Krom Çift Duyulu
Glass Fixture Chrome Lamp HolderÜrün Kodu / Product Code
078 039 130001

MAX. 2x60 W

IP 20

Ambalaj Şekli / Package Type Kutu / Pack

Adet / m / Quantity / m 12

Ağırlık / Weight 14.46

m³ / Volume 0.124**MARTI**Cam Armatür
Glass FixtureÜrün Kodu / Product Code
078 039 130130

MAX. 2x60 W

Ambalaj Şekli / Package Type Kutu / Pack

Adet / m / Quantity / m 12

Ağırlık / Weight 14.46

m³ / Volume 0.124

**MARTI**

Yarım Ay Cam Aplik
Half Moon Glass Wall Lamp

Ürün Kodu / Product Code
078 039 130200

MAX. 2x60 W

Ambalaj Şekli / Package Type	Kutu / Pack
Adet / m / Quantity / m	20
Ağırlık / Weight	14.46
m ³ / Volume	0.124

**ACİLED**

Sıvaüstü Acil Aydınlatma Armatürü
Surface Mounted Emergency Lighting

Ürün Kodu / Product Code

112 039 011717 17 LED

112 039 013434 34 LED

112 039 015151 51 LED

**ACİLED**

Sıvaaltı Acil Aydınlatma Armatürü
Recessed Mounted Emergency Lighting

Ürün Kodu / Product Code

112 039 121717 17 LED

112 039 123434 34 LED

112 039 125151 51 LED

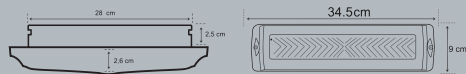



SEYAR AYDINLATMA

EXTENSIBLE PARK AND GARDEN LIGHTING

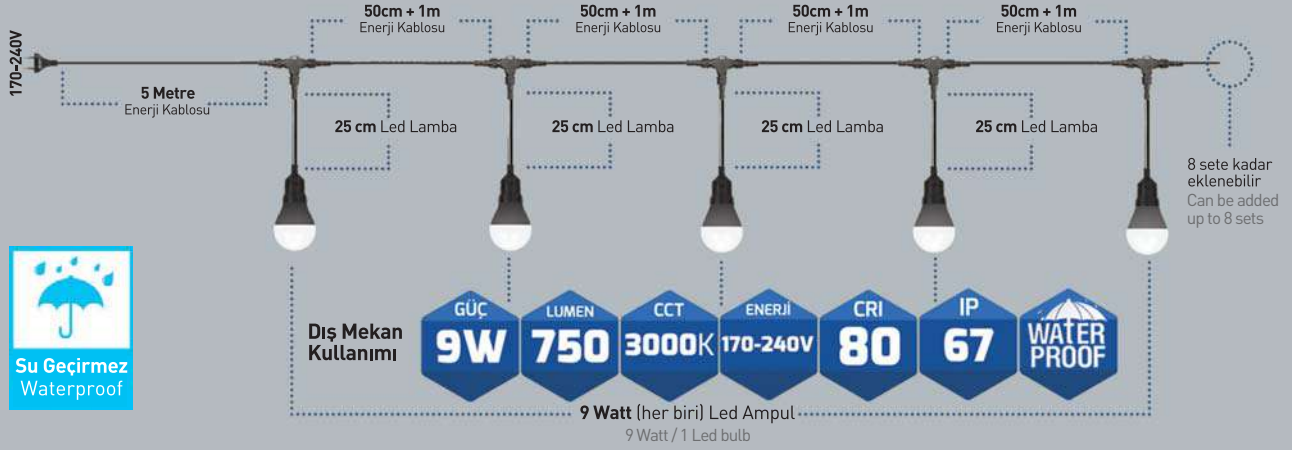

Kod Code	Açıklama Description	Lumen	Güç Power	Işık Sıcaklığı Light Temperature
010 093 100900	9W 5'li Led Lamba Seti Dış Mekan (Park ve Bahçeler için Kurulumu Kolay Seyyar Aydınlatma Seti) Outdoor led lamp set 9 W - 5 Pcs (Easy to mount, can be used park and garden)	750 lm	9W	3000K
010 093 100005	Power Kablo 5 MT 220V (Erkek Soketli) Power cable 5 mt 220V (male socket)			
010 093 100001	T Bağlantı Adaptörü T Branch	750 lm	9W	3000K
010 093 100901	9W Led + Ara Kablo 25cm + Erkek Konnektör Takımı 9W Led + intermediate cable 25 cm + male connector set			
010 093 100000	1 Metre Ara Kablo İki Tarafı Konnektör Takılı 1 meter cable (double side connector)			
010 093 100002	Sonlandırma Tapası End cover			



LED AMPUL LED BULB

Kod Code	Açıklama Description
010 093 100101	Led Ampul 7W-220V (IP 67) Yeşil Led bulb 7W-220V (IP 67) Green
010 093 100102	Led Ampul 7W-220V (IP 67) Kırmızı Led bulb 7W-220V (IP 67) Red
010 093 100103	Led Ampul 7W-220V (IP 67) Mavi Led bulb 7W-220V (IP 67) Blue
010 093 100104	Led Ampul 7W-220V (IP 67) Amber Led bulb 7W-220V (IP 67) Amber
010 093 100105	Led Ampul 7W-220V (IP 67) Soğuk Beyaz Led bulb 7W-220V (IP 67) 6500 K
010 093 100106	Led Ampul 7W-220V (IP 67) Sıcak Beyaz Led bulb 7W-220V (IP 67) 3000 K
010 093 100107	Led Ampul 7W-220V (IP 67) Mor Led bulb 7W-220V (IP 67) Purple



RENKLİ DUY TAKIMI COLOURED LAMP HOLDER

Kod Code	Açıklama Description
010 093 100120	Renkli Duy Takımı (Ampul Hariç) Coloured Lamp Holder (Without Bulb)
010 093 100121	Siyah Duy Takımı (Ampul Hariç) Black Lamp Holder (Without Bulb)



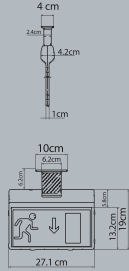

LED ACİL DURUM

Cift Yüzlü Yön Tavan Serisi
Acil Durum Armatürü
Double Sided For Ceiling
Emergency Lighting

Ürün Kodu / Product Code
112 038 1000 - XX

- Dekoratif ABS gövde
- Acilde veya sürekli çalışma
- 1 veya 3 saat yanma süresi
- NI-CD Uzun ömürlü batarya
- Pleksiglas üzeri gravür veya UV uygulama
- Aşırı şarj ve deşarja karşı koruma
- Şarj olma süresi 24 saat

- Decorative ABS Body
- Runs continuously or in Emergency
- Lighting duration of 1 or 3 hours
- NI-CD long life battery
- Engraving on Plexiglass
- Different colour options in bulk orders
- Ultra-bright LEDs

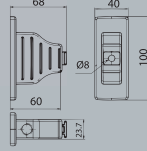

LED ACİL DURUM

Cift Yüzlü Yön Duvar Serisi
Acil Durum Armatürü
Double Sided For Wall Ceiling
Emergency Lighting

Ürün Kodu / Product Code
112 038 2000 - XX

- Dekoratif ABS gövde
- Acilde veya sürekli çalışma
- 1 veya 3 saat yanma süresi
- NI-CD Uzun ömürlü batarya
- Pleksiglas üzeri gravür veya UV uygulama
- Aşırı şarj ve deşarja karşı koruma
- Şarj olma süresi 24 saat

- Decorative ABS Body
- Runs continuously or in Emergency
- Lighting duration of 1 or 3 hours
- NI-CD long life battery
- Engraving on Plexiglass
- Different colour options in bulk orders
- Ultra-bright LEDs

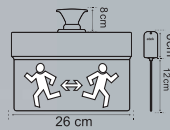

LED ACİL DURUM

Cift Yüzlü (Alüminyum) İşaret Serisi
Acil Durum Armatürü
Double Sided Aluminium
Sign - Emergency Lighting

Ürün Kodu / Product Code
112 038 3000 - XX

- Dekoratif alüminyum eloksal gövde
- Acilde veya sürekli çalışma
- 1 veya 3 saat yanma süresi
- NI-CD Uzun ömürlü batarya
- Pleksiglas üzeri gravür uygulama
- Ultra parlak ledler
- Aşırı şarj ve deşarja karşı koruma
- Şarj olma süresi 24 saat

- Decorative Aluminium Anodised Body
- Option for Lighting continuously or in emergency
- Lighting duration of 1 or 3 hours
- NI-CD long life battery
- Engraving on Plexiglass
- Ultra-Bright LEDs
- Protection against over-charge and discharge
- 24 Hour Charging time

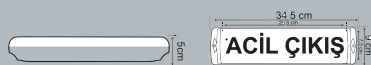

LED ACİL DURUM

Bilgi Serisi
Acil Durum Armatürü
Bilgi Series
Info - Emergency Lighting

Ürün Kodu / Product Code
112 038 4000 - XX

- Acilde 1 veya 3 saat yanma süresi
- NI-CD Uzun ömürlü batarya
- Acilde veya sürekli çalışma
- Akrilik üzeri folyo uygulama
- Şarj olma süresi 24 saat

- Lighting duration of 1 or 3 hours
- NI-CD long life battery
- Option for Lighting continuously or in emergency
- Foil printing on acrylic board
- 24 Hour Charging time



LED ACİL DURUM

**Cift Yüzlü Sıvaüstü Serisi
Acil Durum Armatürü**
Double Sided S/M
Emergency Lighting

Ürün Kodu / Product Code
112 038 5000 - XX

- Çağdaş ve şık tasarım
- Acilde veya sürekli çalışma
- 1 veya 3 saat yanma süresi
- NI-CD Uzun ömürlü batarya
- Pleksiglas üzeri gravür uygulama
- Sıva üstü kullanım ile tavana montaj
- Ultra parlak ledler
- Aşırı şarj ve deşarja karşı koruma
- Şarj olma süresi 24 saat
- Dekoratif ABS gövde

- Modern and Elegant Design
- Option for Lighting continuously or in Emergency
- Lighting duration of 1 or 3 hours
- NI-CD long life battery
- Engraving on Plexiglass
- Surface mounted on ceiling
- Ultra-bright LEDs
- 24 Hour Charging time
- Protection against over-charge and discharge
- Decorative ABS Body



LED ACİL DURUM











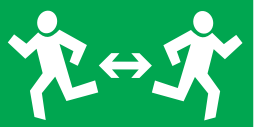

**Cift Yüzlü Sıvaaltı Serisi
Acil Durum Armatürü**
Double Sided F/M
Emergency Lighting

Ürün Kodu / Product Code
112 038 6000 - XX

- Çağdaş ve şık tasarım
- Acilde veya sürekli çalışma
- 1 veya 3 saat yanma süresi
- NI-CD Uzun ömürlü batarya
- Pleksiglas üzeri gravür uygulama
- Sıva altı kullanım ile tavana montaj
- Ultra parlak ledler
- Aşırı şarj ve deşarja karşı koruma
- Şarj olma süresi 24 saat
- Dekoratif ABS gövde

- Modern and Elegant Design
- Option for Lighting continuously or in Emergency
- Lighting duration of 1 or 3 hours
- NI-CD long life battery
- Engraving on Plexiglass
- Recessed Mounted on ceiling
- Ultra-bright LEDs
- 24 Hour Charging time
- Protection against over-charge and discharge
- Decorative ABS Body

SEMBOL KOD TABLOSU SYMBOL CODES

01	ÇIKIŞ	02	EXIT	03		04	
05		06		07		08	
09		10		11		12	
13		14		15		16	خروج
17	ÇIKIŞ EXIT	18	ВЫХОД				

LED EXIT - ŞEFFAF ACİL AYDINLATMA ARMATÜRLERİ IP20

102 038 000801
CEXA-8-01102 038 000802
CEXA-8-02102 038 000803
CEXA-8-03102 038 000804
CEXA-8-04102 038 000805
CEXA-8-05102 038 000806
CEXA-8-06102 038 000807
CEXA-8-07102 038 000808
CEXA-8-08102 038 000809
CEXA-8-09102 038 000810
CEXA-8-10102 038 000811
CEXA-8-11102 038 000812
CEXA-8-12102 038 000813
CEXA-8-13102 038 000814
CEXA-8-14102 038 000815
CEXA-8-15102 038 000816
CEXA-8-16102 038 000817
CEXA-8-17102 038 000818
CEXA-8-18102 038 000819
CEXA-8-19102 038 000820
CEXA-8-20102 038 000821
CEXA-8-21102 038 000822
CEXA-8-22102 038 000823
CEXA-8-23102 038 000824
CEXA-8-24102 038 000825
CEXA-8-25102 038 000826
CEXA-8-26102 038 000827
CEXA-8-27

FOSFORLU SERİ ACİL AYDINLATMA ARMATÜRLERİ IP20

102 038 000901
CEXA-FS 1102 038 000902
CEXA-FS 2102 038 000903
CEXA-FS 3102 038 000904
CEXA-FS 4102 038 000905
CEXA-FS 5102 038 000906
CEXA-FS 6



Mutlusan Plastik Elektrik Tic. ve San. A.Ş.

İkitelli Org.San. Bölgesi Mahallesi Enkoop Cad.
No:7 Basakşehir- İstanbul
Tel : +90 (212) 485 05 44 (PBX)
Faks : +90 (212) 485 10 12

Karaköy Şube

Okçumusa Cad. Güneşan İş Hanı No : 24/10
Karaköy-İstanbul
Tel : +90 (212) 237 06 02 (PBX)
Fax: +90 (212) 237 77 47

Perpa Şube

Perpa Tic. Merkezi. A Blok Kat: 2
No: 9-009 Okmeydanı - İstanbul
Tel : +90 (212) 320 05 78 (PBX)
Fax: +90 (212) 320 05 81



mutlusan.com.tr